

Study of the $B^0 \rightarrow \gamma\gamma$ decay at Belle and Belle II

La Thuile 2024-Les Rencontres de Physique de la Vallée d'Aoste

March 3-9, 2024, La Thuile, Aosta Valley, Italy

Shubhangi Krishan Maurya

Indian Institute of Technology Guwahati, India

On behalf of the Belle and Belle II Collaboration



Significance of rare decay of $B^0 \rightarrow \gamma\gamma$

- In the Standard Model (SM), this decay mode is a flavor-changing neutral current (FCNC) process involving penguin diagrams.
- The FCNC processes are forbidden in the SM at the tree level, as in the case of $b \rightarrow d$, there is no direct coupling between the b quark and d quark.
- This mode is sensitive to new physics that could enhance branching fraction due to the possible contribution of **non-SM heavy particles**.

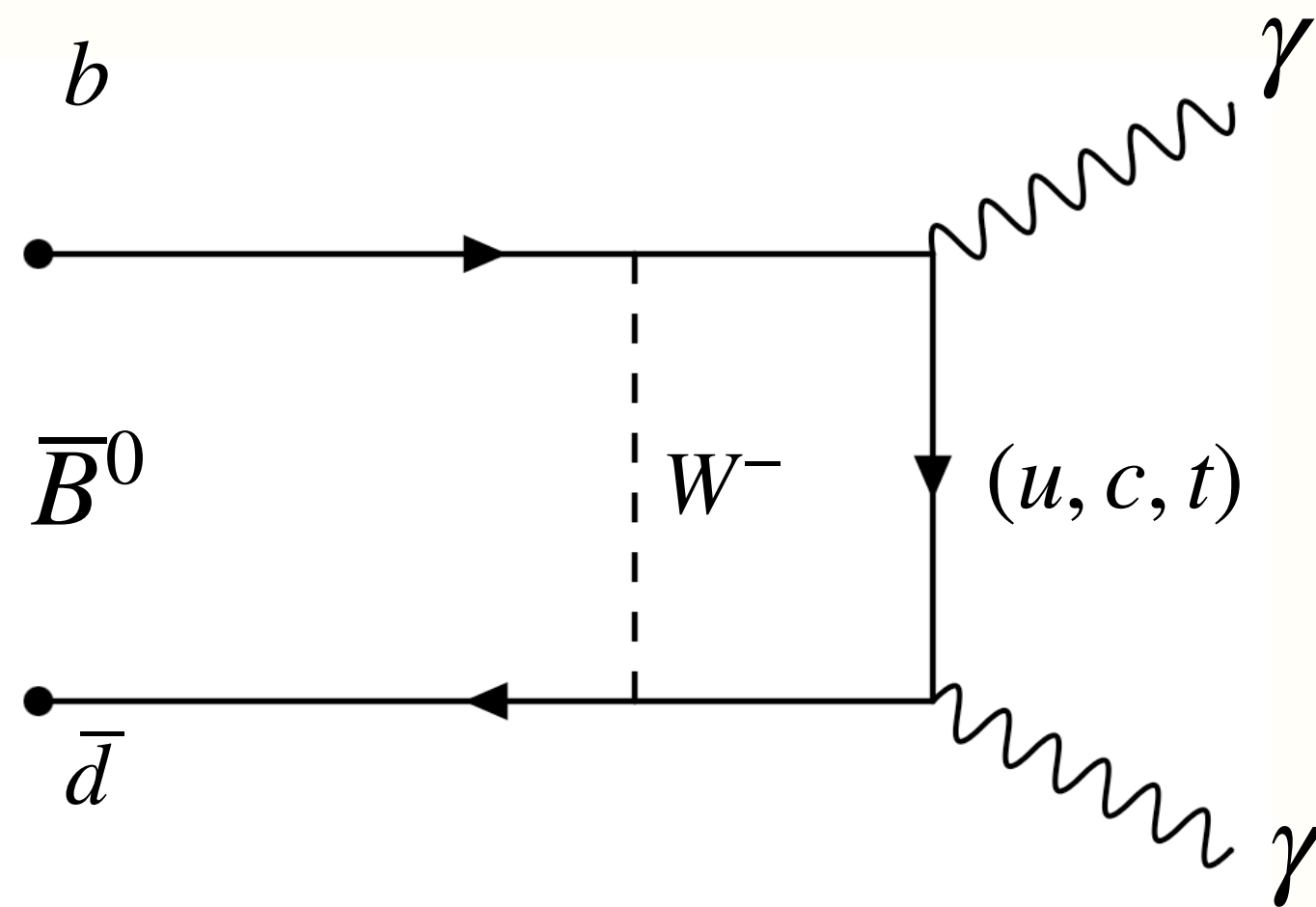

Previous searches	Measurement at 90 % CL
L3 collaboration ($\int \mathcal{L} dt = 73 \text{ pb}^{-1}$)	$< 3.9 \times 10^{-5}$
Belle collaboration ($\int \mathcal{L} dt = 104 \text{ fb}^{-1}$)	$< 6.2 \times 10^{-7}$
BABAR collaboration ($\int \mathcal{L} dt = 426 \text{ fb}^{-1}$)	$< 3.2 \times 10^{-7}$

[Phys. Lett. B363 137](#)

[Phys. Rev. D.73.051107](#)

[Phys. Rev. D.83.032006](#)

Theoretically, the BF of this decay mode is expected to be $1.4_{-0.8}^{+1.4} \times 10^{-8}$ ¹.

- We perform the first Belle and Belle II measurement using a data set of 694 fb^{-1} from Belle and the dataset of Belle II ($\approx 362 \text{ fb}^{-1}$) from the Run1 period.

Belle vs Belle II Detector

Belle Detector

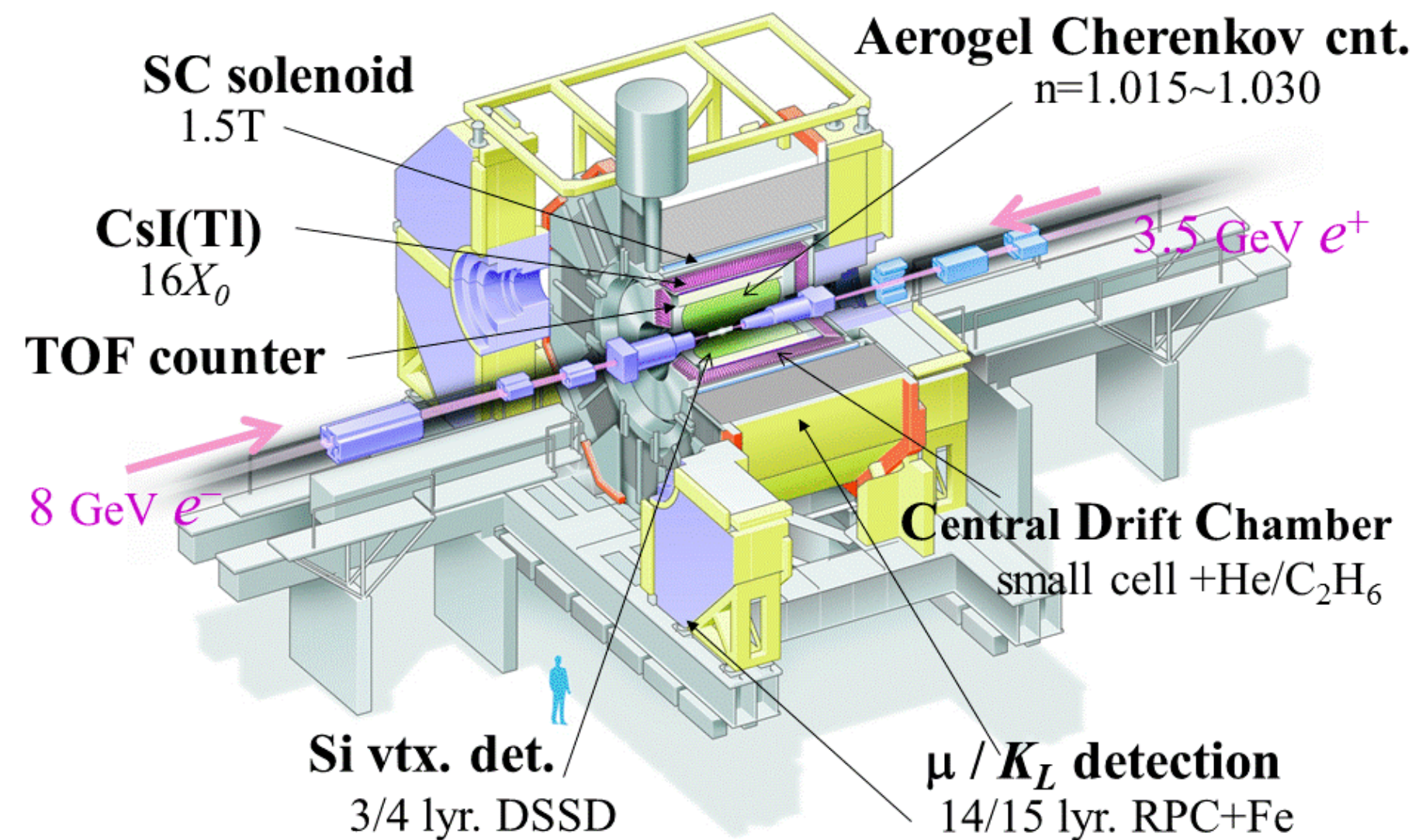

Belle II Detector

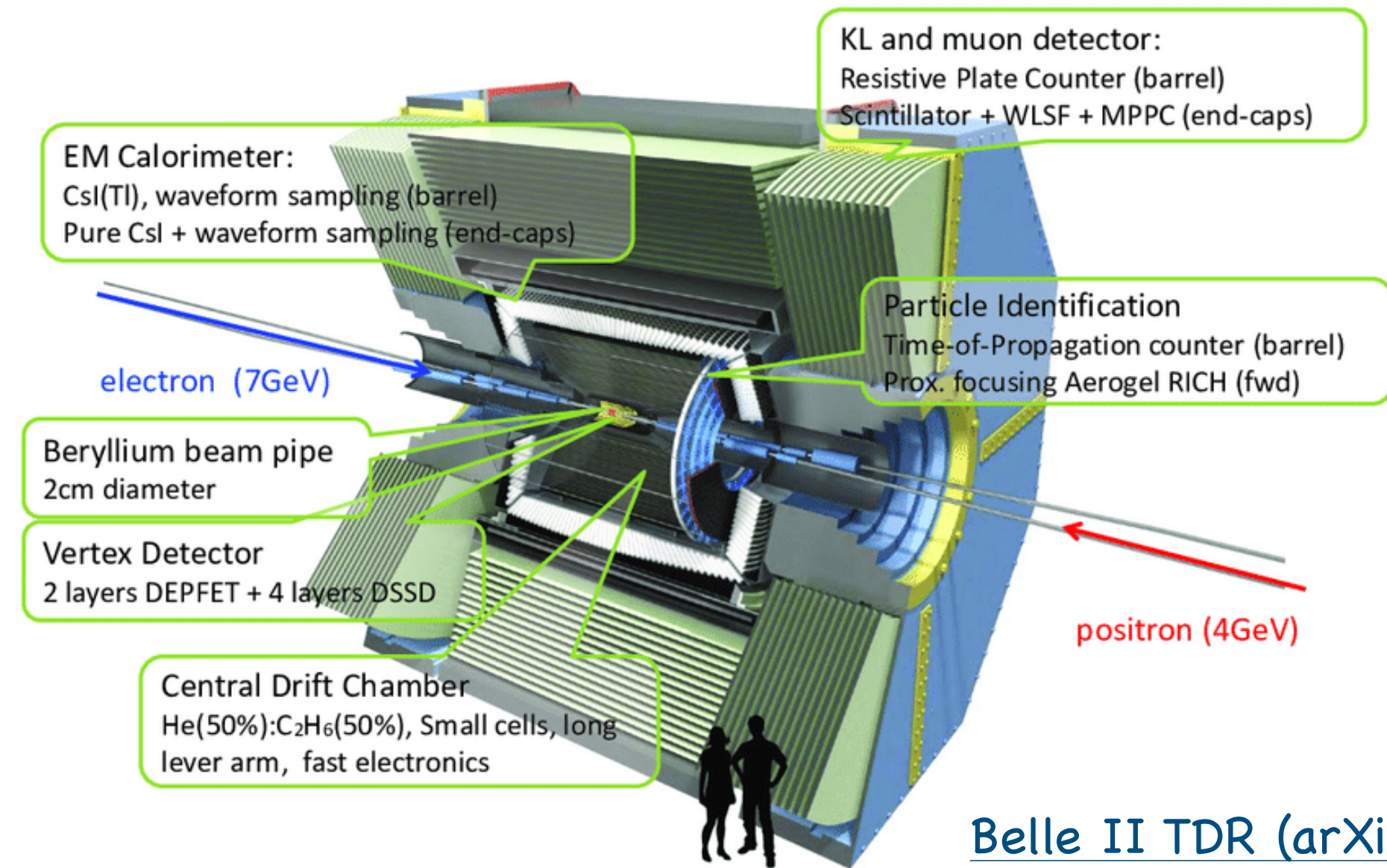

Belle II TDR (arXiv:1011.0352)

Belle TDR: Nucl. Instrum. Method A479, 112 (2002)

- KEKB: 8 GeV e^- vs 3.5 GeV e^+
- Instantaneous Luminosity: $2.11 \times 10^{34} \text{ cm}^{-2} \text{ s}^{-1}$
- Data taken from 1999 to 2010
- Data accumulated: 1 ab^{-1} (694 fb^{-1} at $\Upsilon(4S)$)

- SuperKEKB: 7 GeV e^- vs 4 GeV e^+
- Achieved world-record peak luminosity of $4.7 \times 10^{34} \text{ cm}^{-2} \text{ s}^{-1}$
- Data taken between 2019 - 2022 (362 fb^{-1} at $\Upsilon(4S)$)
- Planned data collection: 50 ab^{-1} by the early 2030s

Analysis in a Nutshell

Reconstruction and selection

Challenging due to neutral final states, smaller signal rate
Large backgrounds

- Signal events are reconstructed from the two highly energetic photons.
- Reject the photon candidates from asymmetric π^0 and η decays.

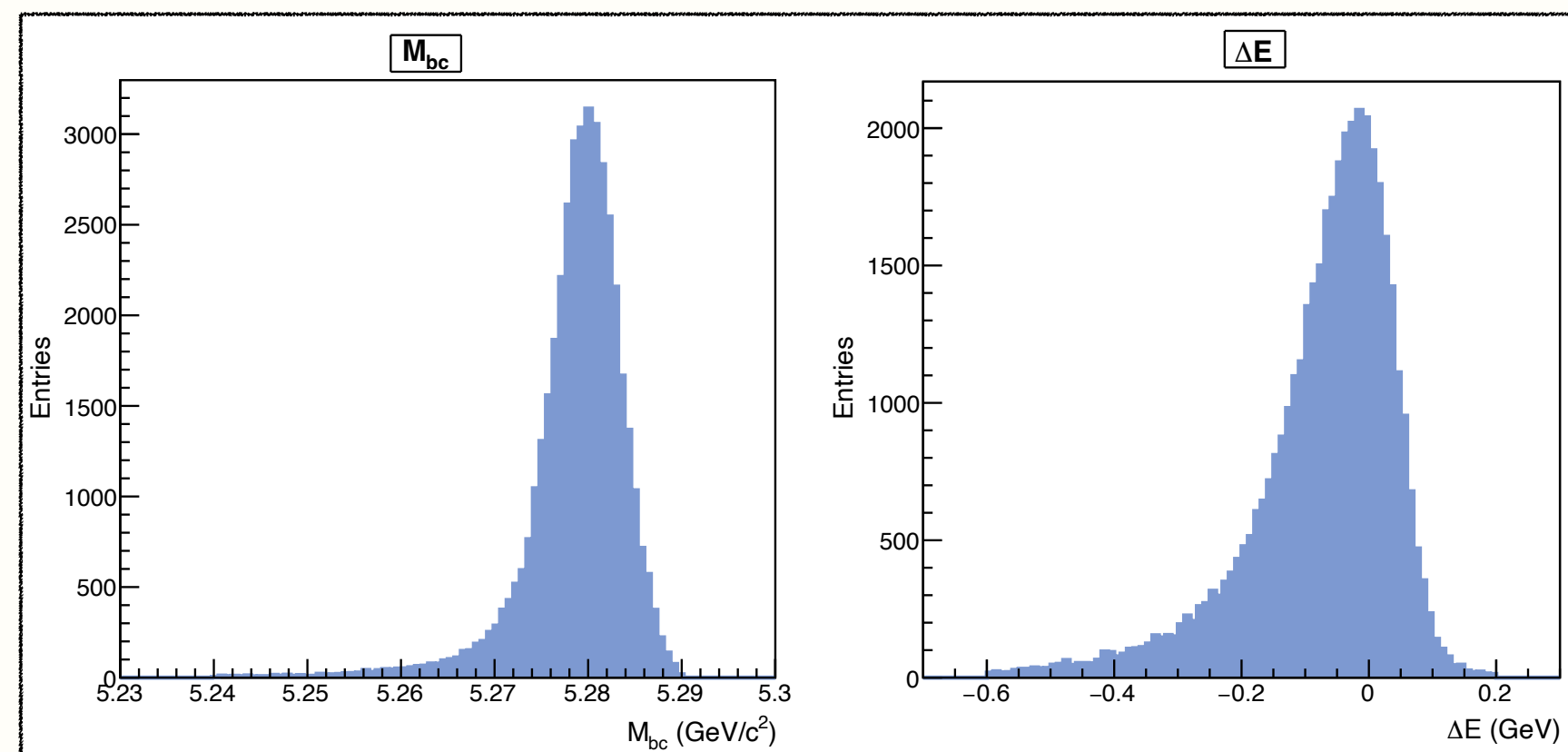

- B^0 candidate is selected based on M_{bc} and ΔE .

$$M_{bc} = \sqrt{(E_{beam}^{CM})^2 - (p_{B^0}^{CM})^2}$$

$$\Delta E = E_{B^0}^{CM} - E_{beam}^{CM}$$

- All the selection cuts are optimized.

Background Study

$$e^+e^- \rightarrow udsc \text{ (} u\bar{u}, d\bar{d}, s\bar{s}, c\bar{c}\text{)}$$

$$e^+e^- \rightarrow B^+B^- \text{ (Charged)}$$

$$e^+e^- \rightarrow B^0\bar{B}^0 \text{ (Mixed)}$$

- 90% of bkg contamination from $q\bar{q}$.

$$e^+e^- \rightarrow q\bar{q} (q : u, d, s, c)$$

- Background from the other B^0 decays, such as $\pi^0\pi^0$ can mimic the signal if photons are merged.

- Largest contribution from $B^0 \rightarrow \pi^0\pi^0$ constitutes only 0.63% of the expected signal events \rightarrow considered negligible.

Background Suppression

- Background suppression was optimized separately for Belle and Belle II.
- Event shape variables are fed to the BDT classifier for discrimination.

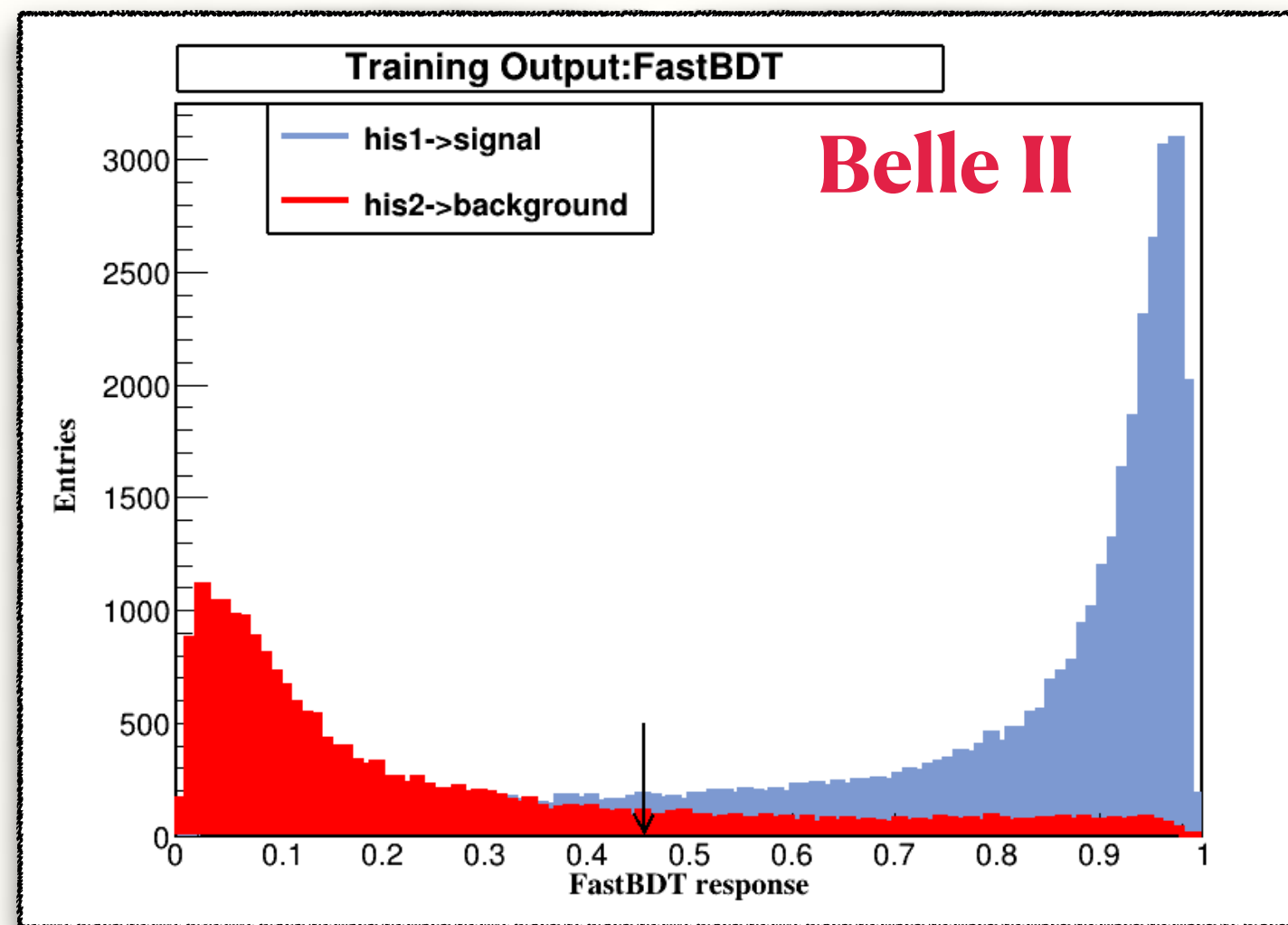
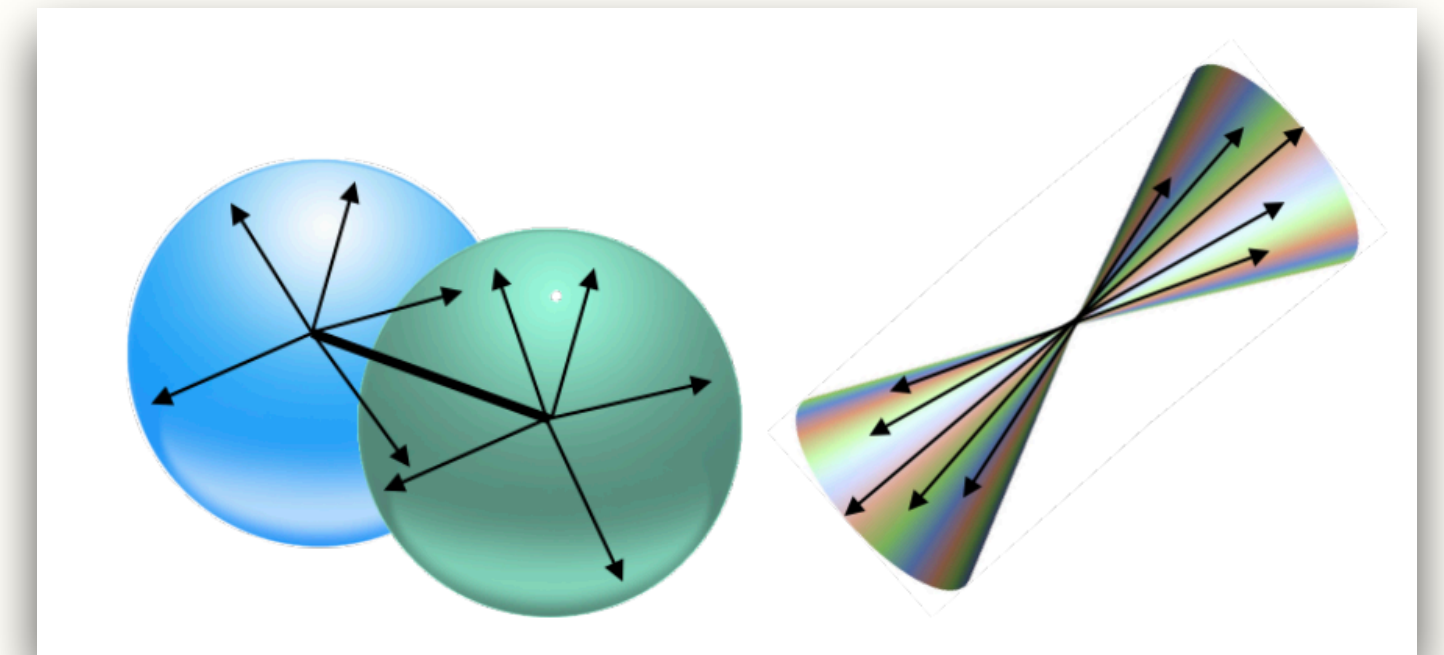

Signal retains = 86%,
Bkg loss = 93% (Belle).

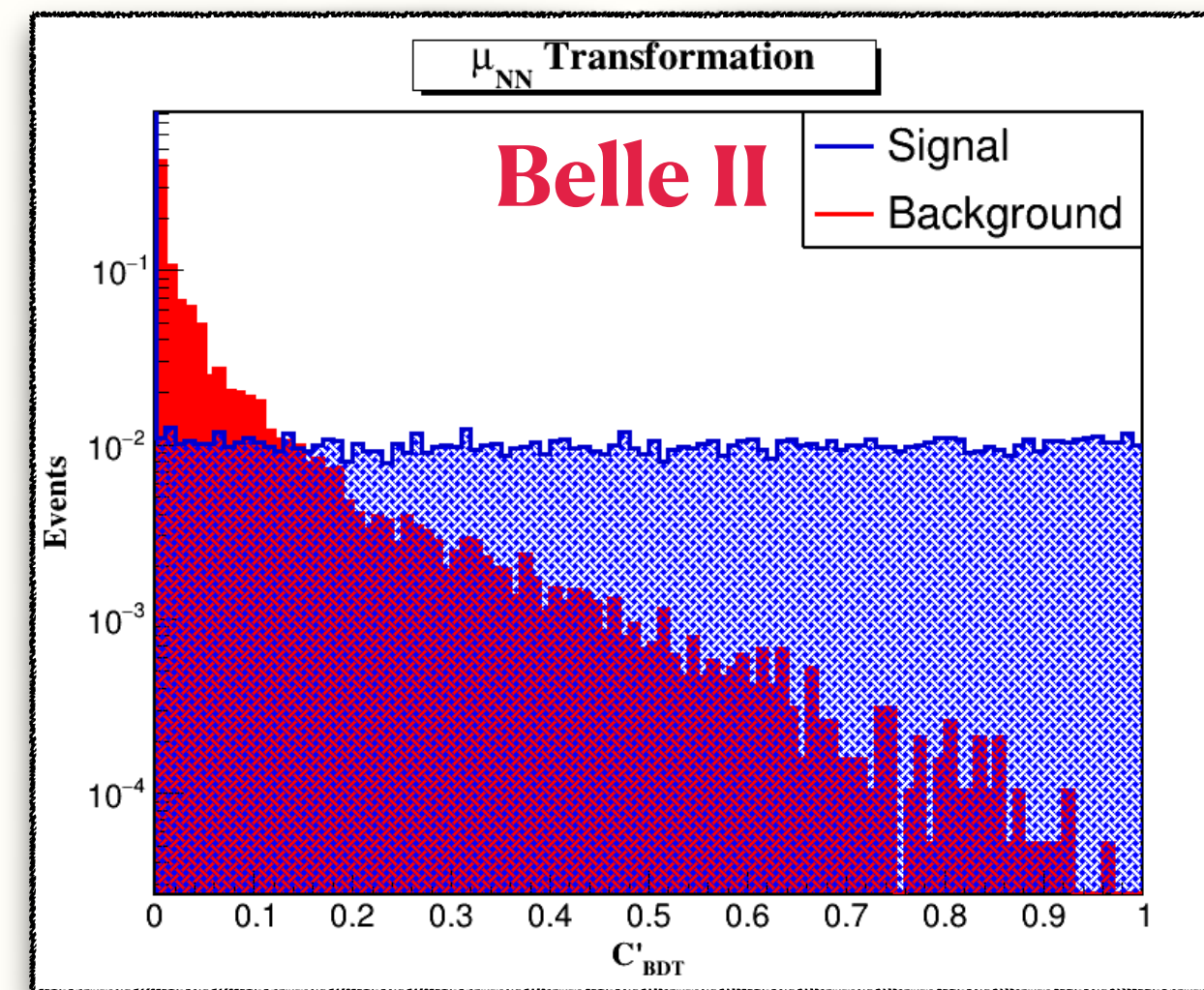

Signal retains = 89%,
Bkg loss = 87% (Belle II)

Overall **better performances in Belle II**

- Improvement in the detector.
- Advanced data analysis techniques.

	Belle	Belle II
Sig efficiency	23%	31%
Exp. bkg/fb ⁻¹	~ 0.8	

Signal Extraction

3D Fit model: $\mathcal{P}(M_{bc}, \Delta E) \times \mathcal{P}(C'_{\text{BDT}})$

Signal PDFs

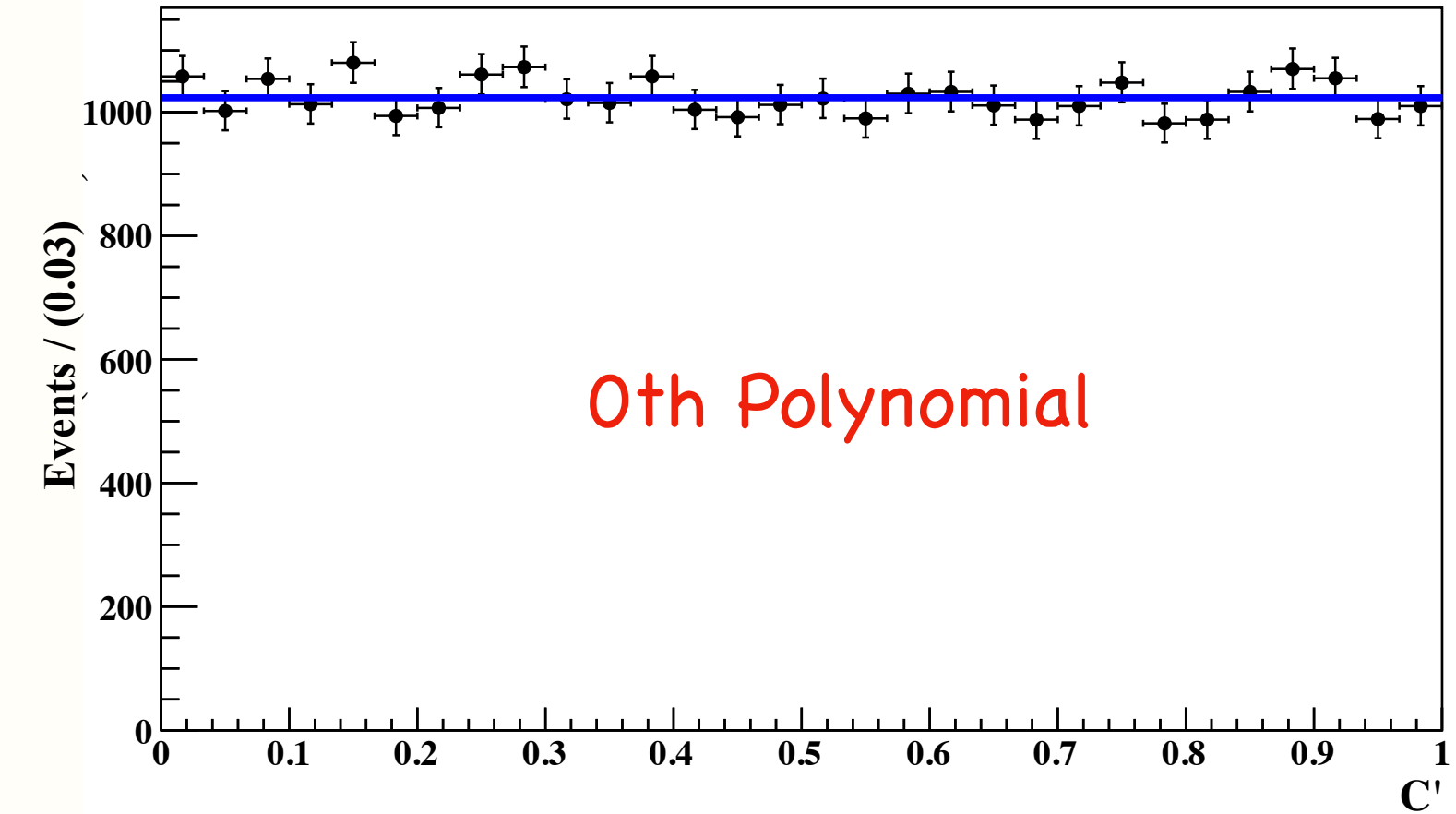
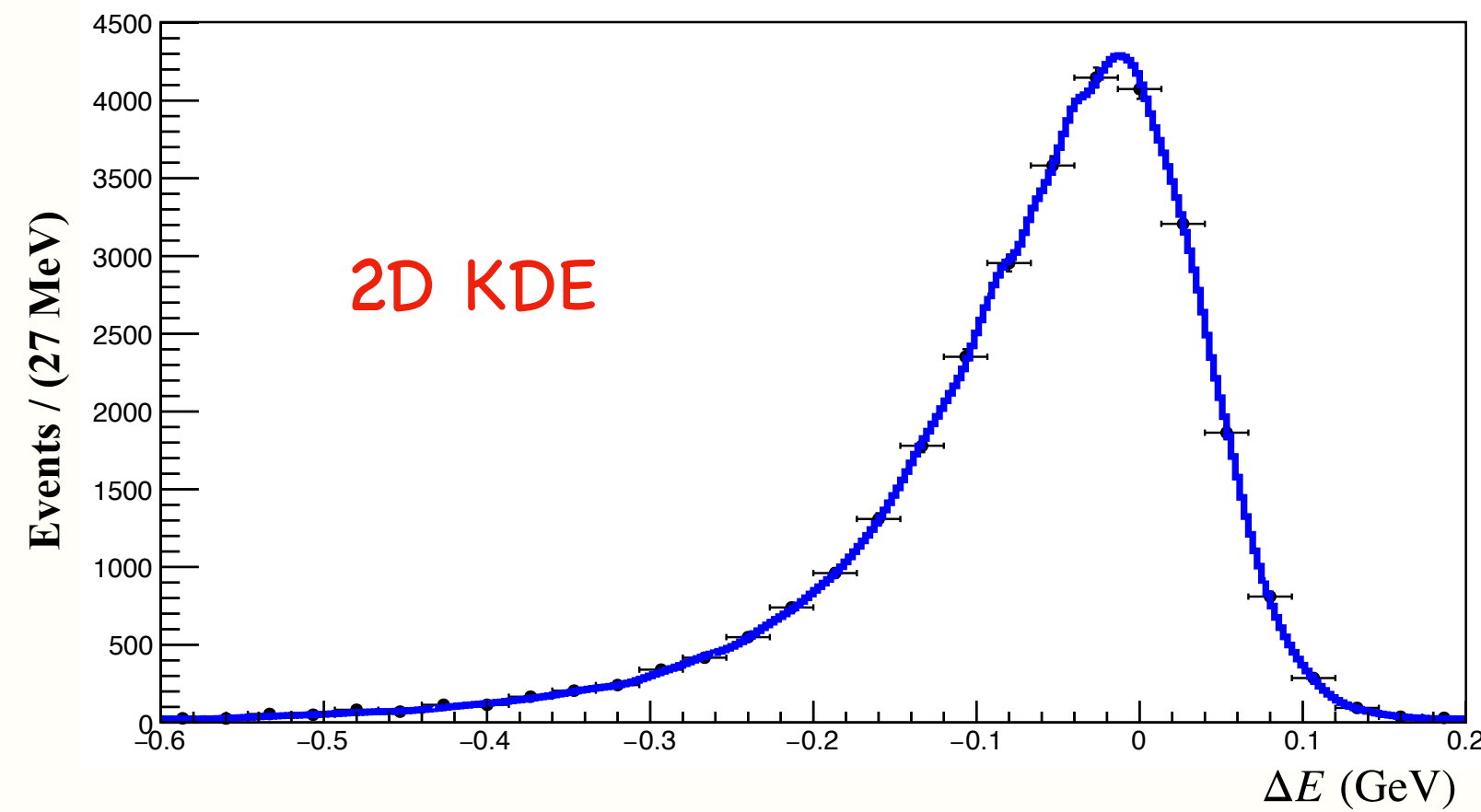
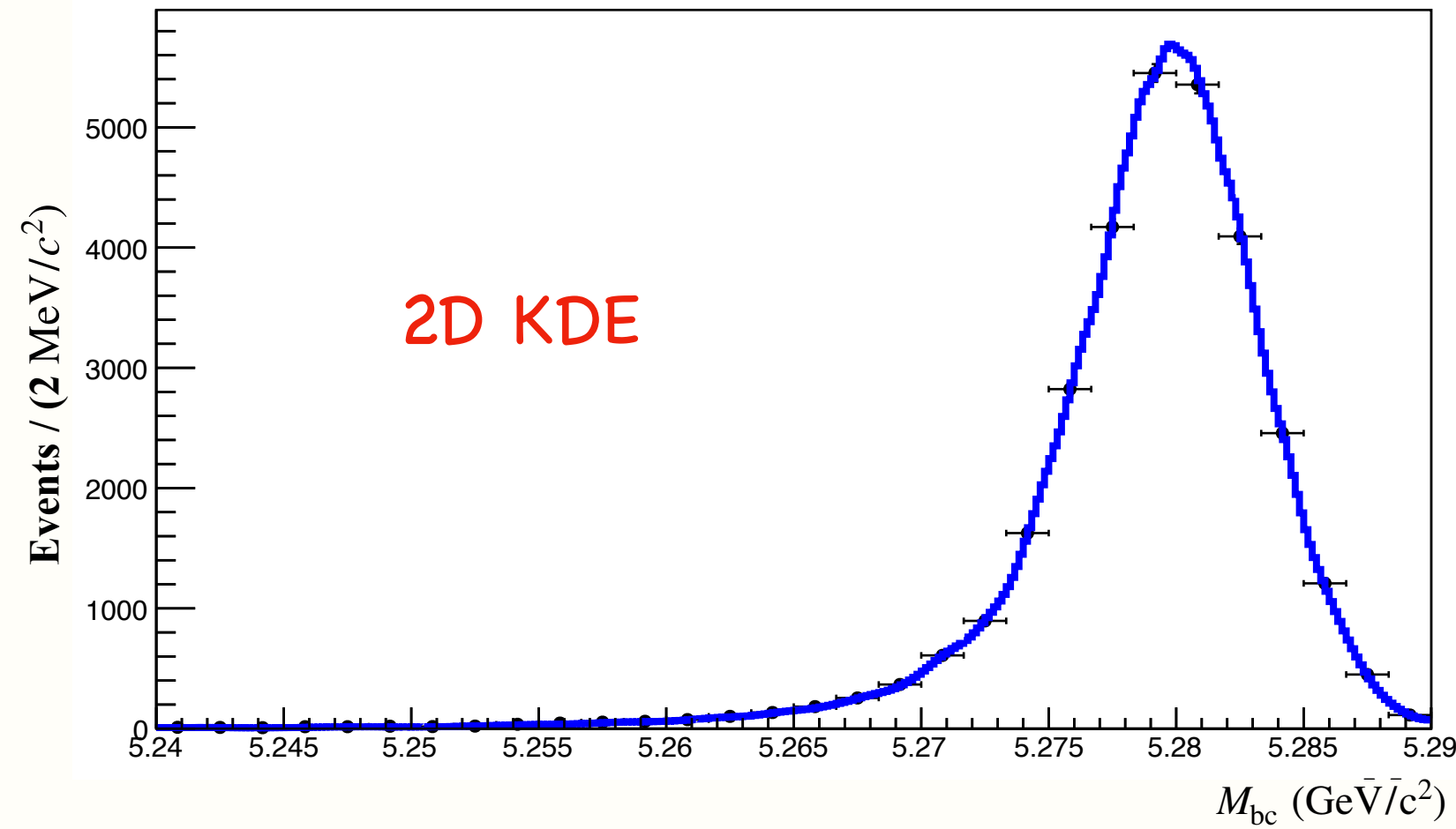

Background PDFs

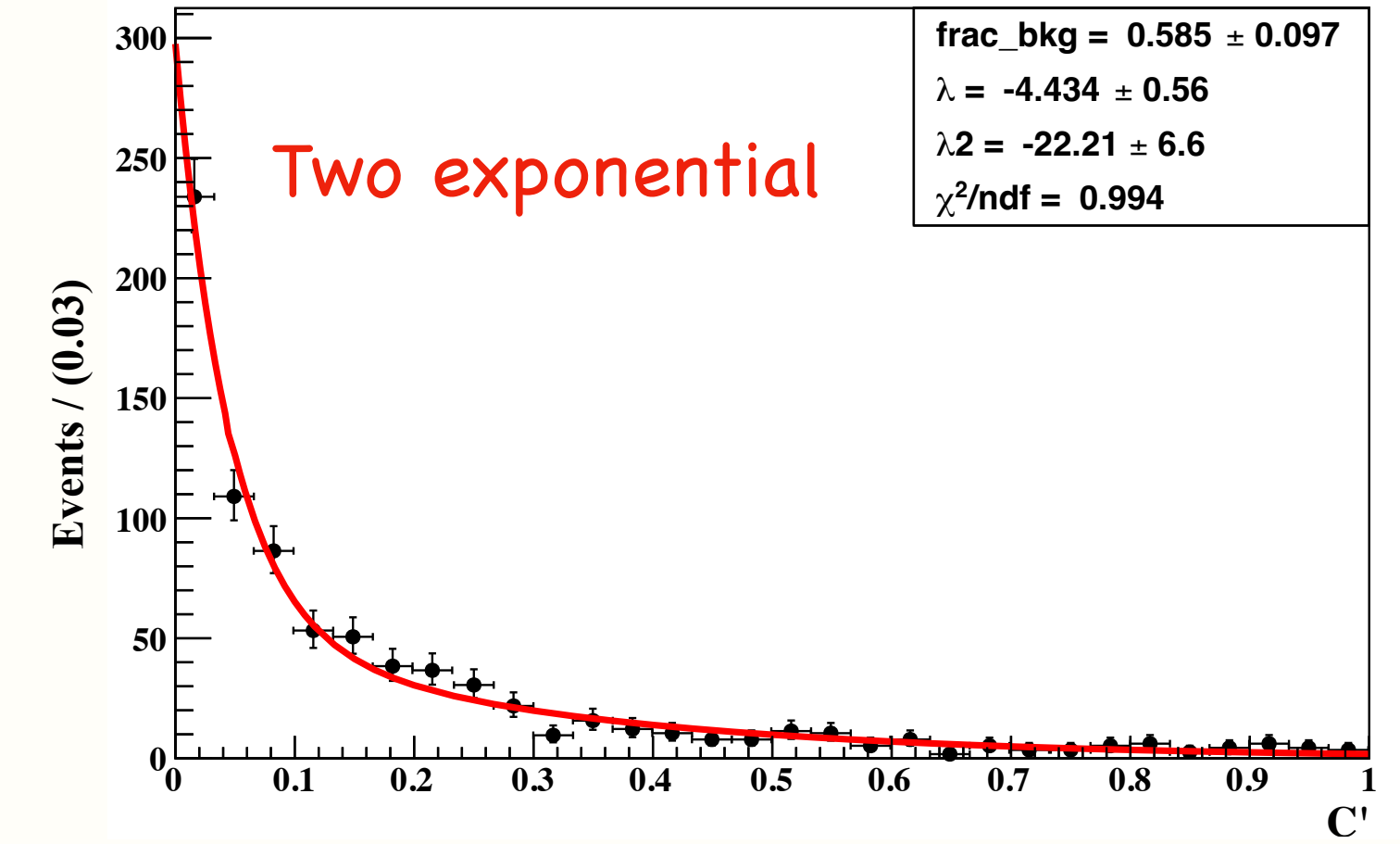
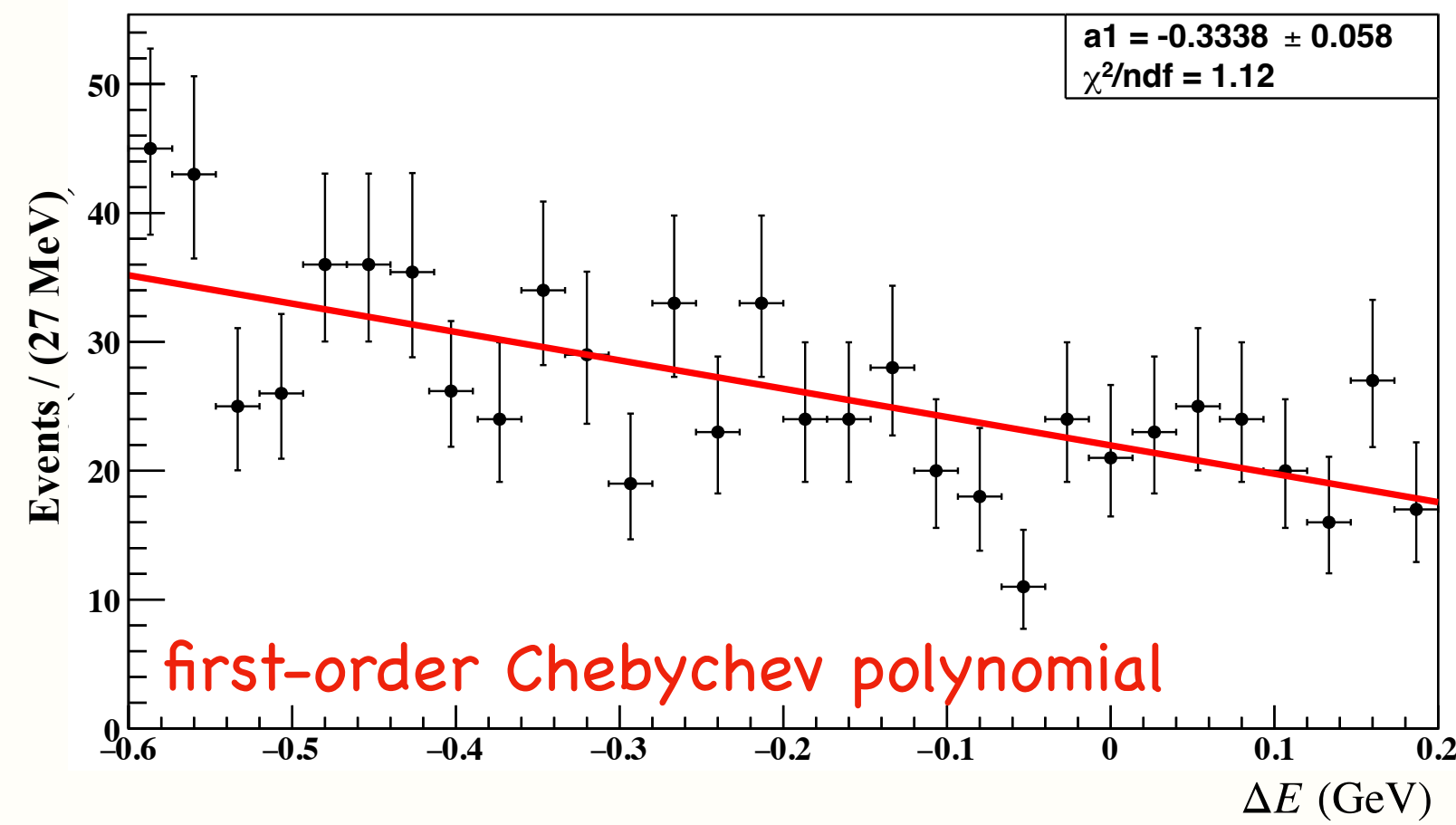
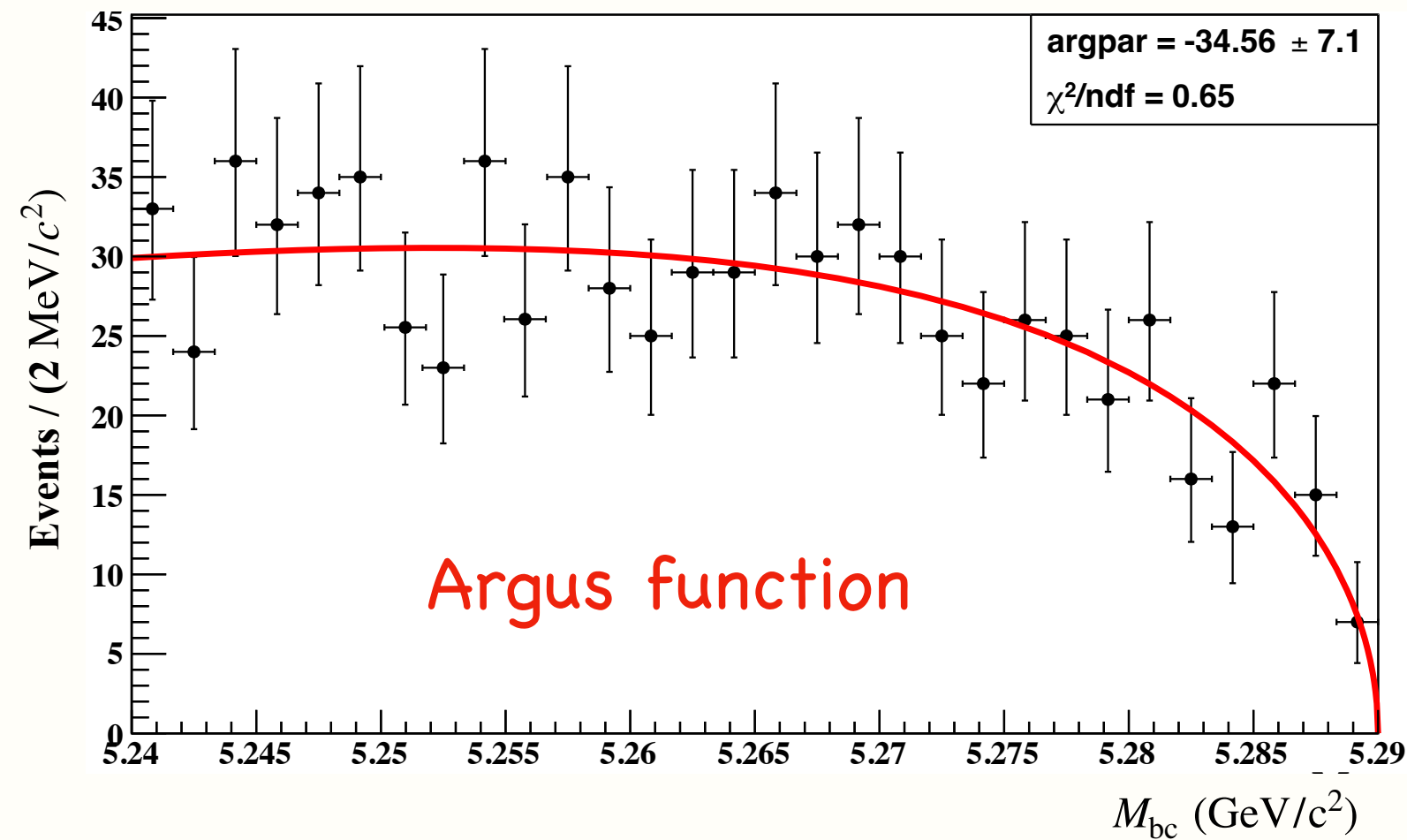

Belle plots - in backup

Validation

- Control mode $B^0 \rightarrow K^{*0}\gamma$ is used to study the data/MC differences.

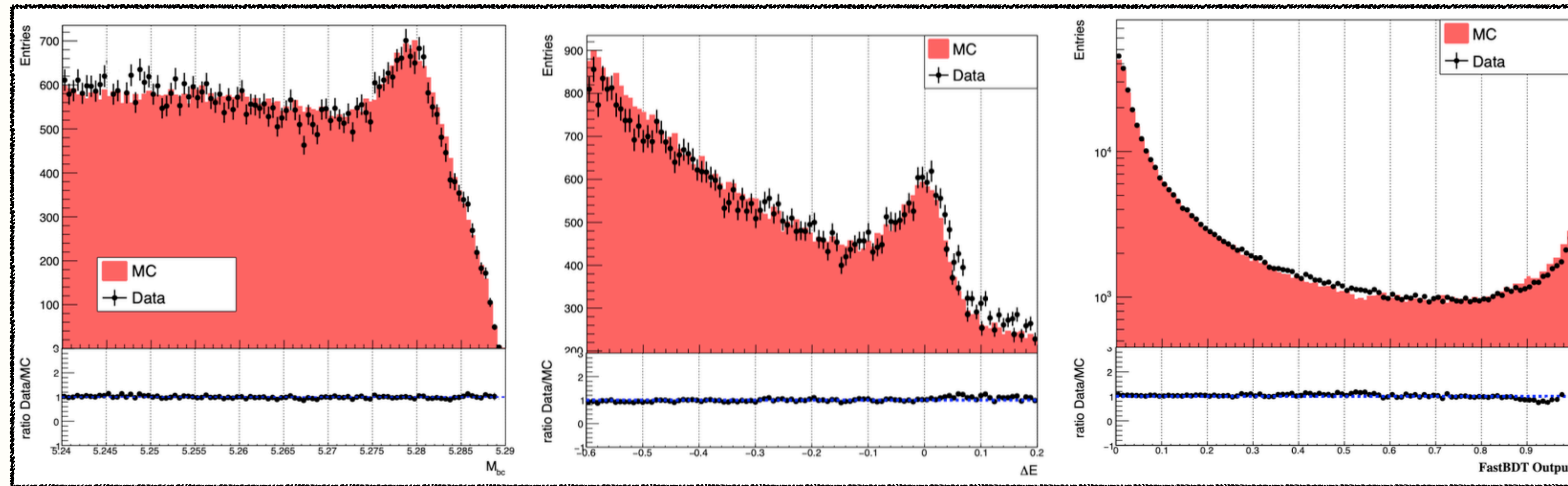

Overall, good Data-MC agreement.

- Calibration is performed for the BDT and π^0/η veto selection. Calibration => Signal efficiency, Uncertainty => Systematics
- Off-resonance data is used to validate the modeling of $q\bar{q}$ backgrounds.

- We have performed the ensemble tests to assess the stability and bias of the fit procedure and model.
- Assigned systematic uncertainty from the fit bias.

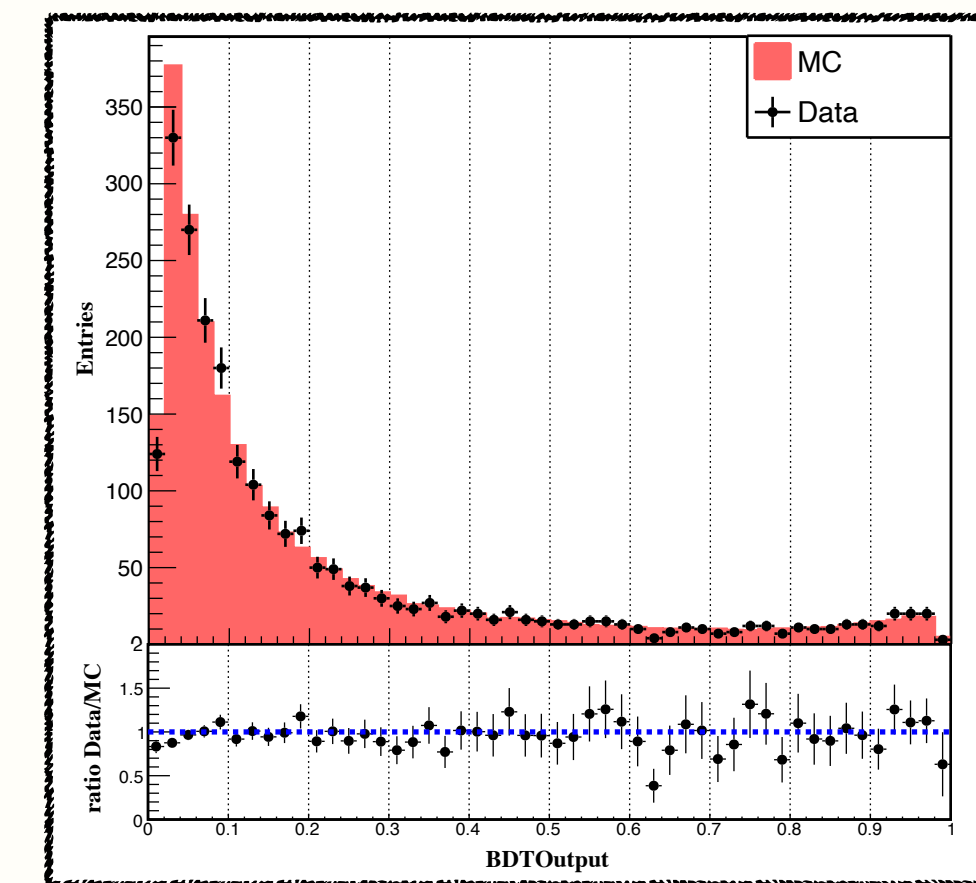

Systematic Uncertainty

Belle II

Uncertainties on Signal Efficiency	Fractional uncertainties (%)
Number of $B\bar{B}$	2.89
Photon Efficiency	2.70
BDT selection	0.90
Reconstruction Efficiency	0.45
π^0/η Veto	0.40
Total	4.10
Uncertainties on Signal Yield	uncertainties (events)
PDF shape Parameter	+0.28 -0.32
Fit Bias	+ 0.12
Signal Shape Modeling	+ 0.04
Total	+0.30 -0.32

Dominant sources of systematic uncertainty

- Number of $B\bar{B}$ pairs
- Photon Efficiency
- PDF shape parameter

Negligible impact on the limit

Belle - in backup

Combined Result (Belle+Belle II)

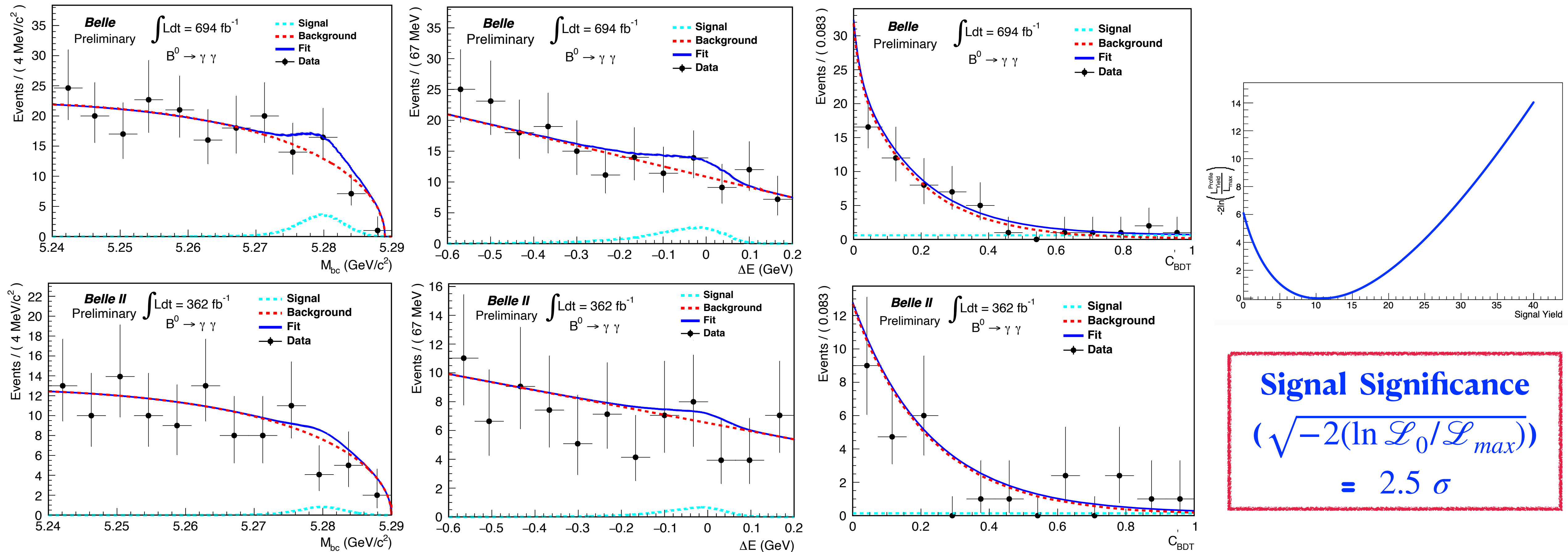

- Simultaneous 3D unbinned ML fitting on M_{bc} , ΔE and C'_{BDT} using Belle and Belle II data sets.

Signal Yield = $11^{+6.5}_{-5.5}$ 2.5σ significance wrt the background only hypothesis

Approaching SM sensitivity

Combined Results

- No signal evidence → set UL at 90% CL
- $\mathcal{B}(B^0 \rightarrow \gamma\gamma) < 6.4 \times 10^{-8}$ at 90% CL.
- Improvement by a factor of five over the previous UL set by the Babar experiment with 426 fb^{-1} ($< 3.2 \times 10^{-7}$ at 90% CL).

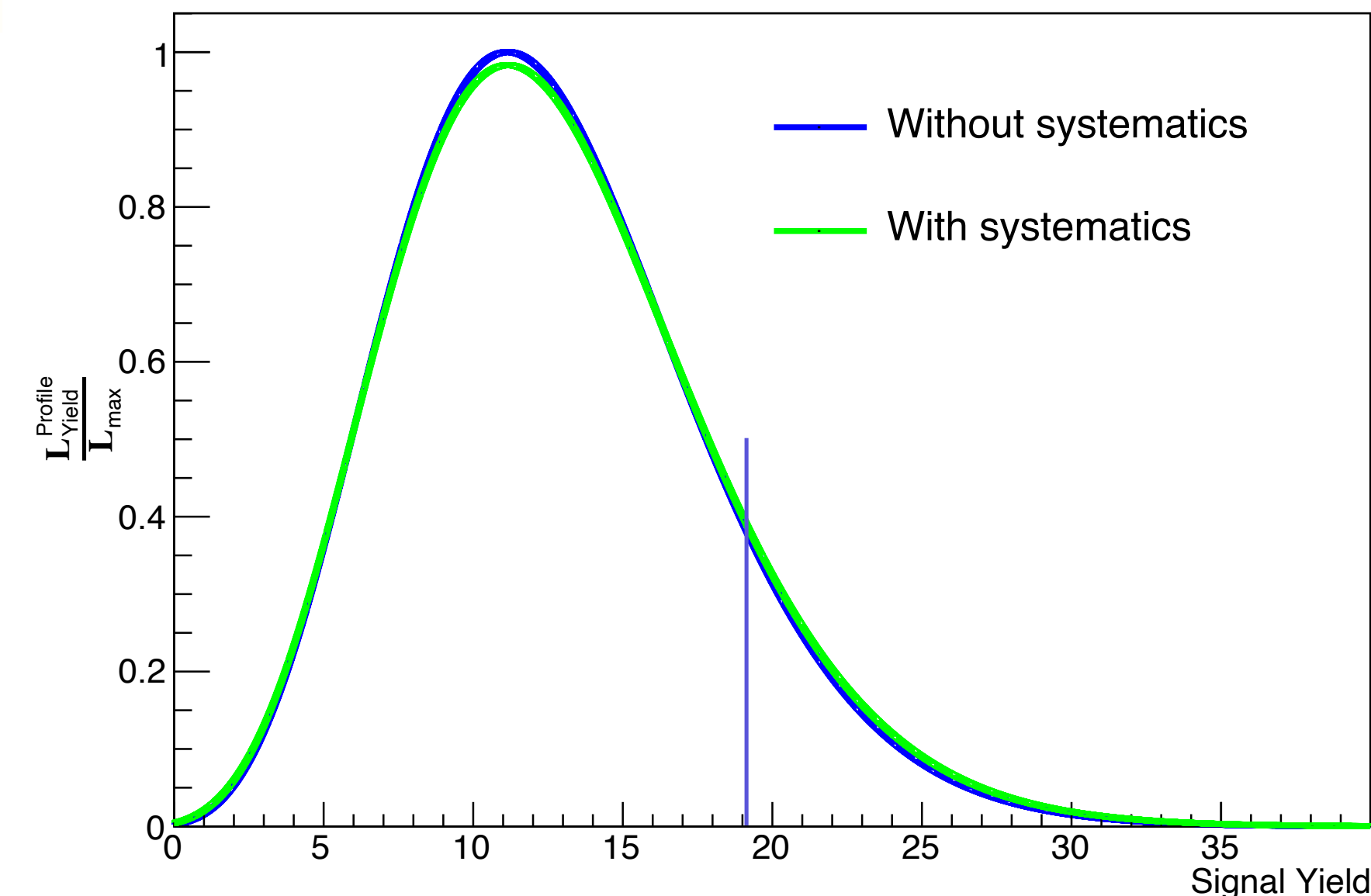

Improvements

Increased Statistics (Belle+Belle II)

Improved analysis techniques.

Better Signal Efficiency

Improved Background reduction

$$\mathcal{B}(B^0 \rightarrow \gamma\gamma) = (3.7_{-1.8}^{+2.2}(\text{stat}) \pm 0.7(\text{sys})) \times 10^{-8}$$



Upper limit on Branching fraction: $< 6.4 \times 10^{-8}$ at 90% CL

World Best UL (Previous world best $< 3.2 \times 10^{-7}$) [BaBar, PRD.83.032006]

Summary

- We performed an analysis of the Belle and Belle II datasets corresponding to an integrated luminosity of 694 fb^{-1} and 362 fb^{-1} collected at $\Upsilon(4S)$ resonance, respectively.
- We observed $11.0_{-5.5}^{+6.5}$ signal events with the significance of 2.5σ and measured the combined branching fraction to be $(3.7_{-1.8}^{+2.2}(\text{stat}) \pm 0.7(\text{sys})) \times 10^{-8}$.
- Without any significant signal yield, we used the Bayesian approach to estimate the UL on the branching fraction.
- The estimated UL for the combined measurement $< 6.4 \times 10^{-8}$ at 90% CL which is an improvement by a factor of five over the previous UL $< 3.2 \times 10^{-7}$ at 90% CL set by BaBar.
- Results are approaching SM prediction ($\mathcal{B}(B^0 \rightarrow \gamma\gamma) = 1.4_{-0.8}^{+1.4} \times 10^{-8}$) [JHEP, (2020)169].



Thank you!

Backup Slides



Belle/Belle II Status

Integrated luminosity of B factories

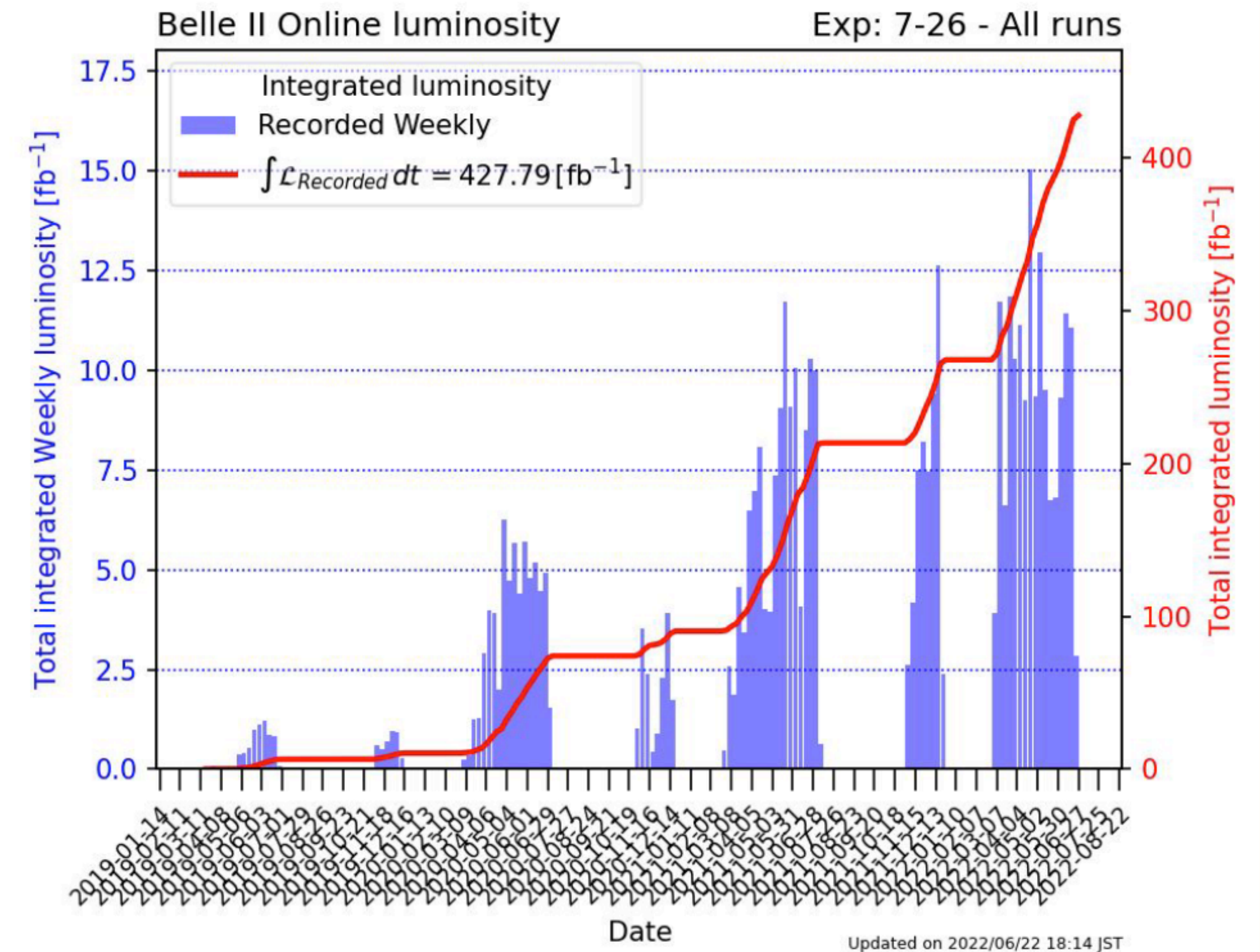
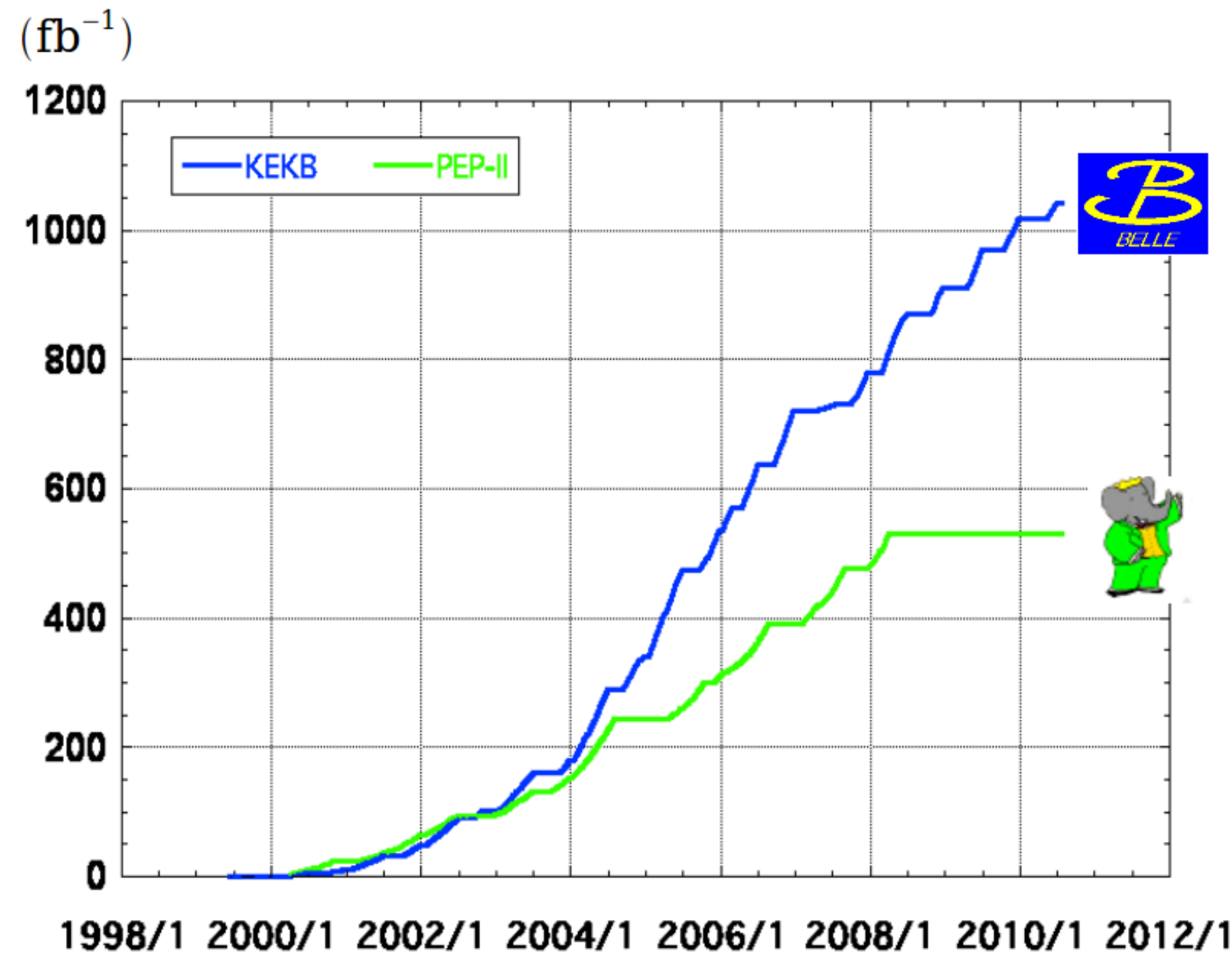

Data taking has resumed from February 20, 2024 after a long shutdown period, during which the accelerator and detector have improved. Recorded total integrated luminosity of $\sim 424 \text{ fb}^{-1}$ – equivalent to BaBar dataset. $\Upsilon(4S)$ on-resonance: $362 \text{ fb}^{-1} \sim 1/2$ of Belle sample
 42 fb^{-1} data collected 60 MeV below $\Upsilon(4S)$ peak 19 fb^{-1} taken around 10.75 GeV for exotic hadron searches

1D PDF Parameterization for Belle

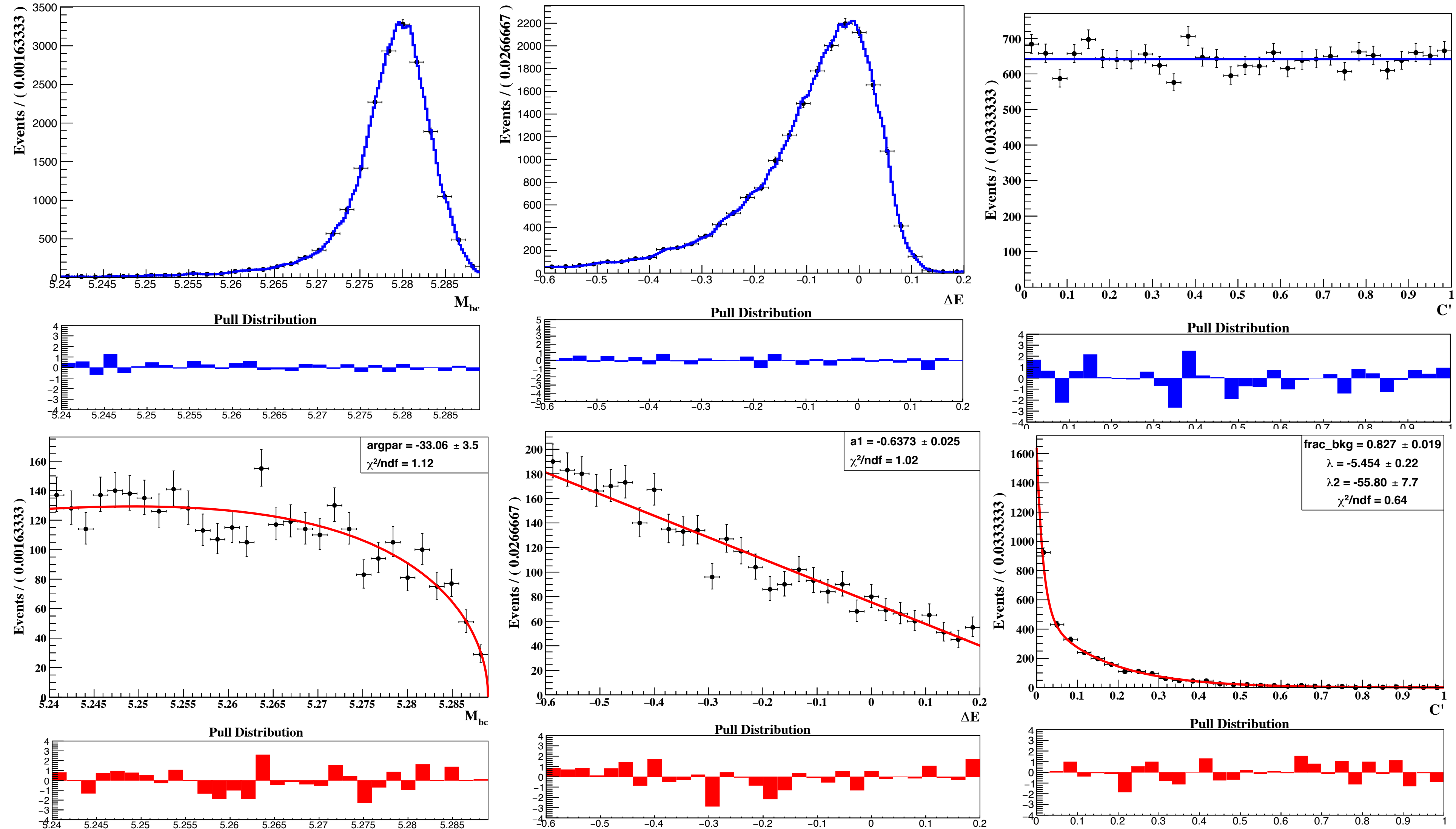

Fig: Pdf shapes of M_{bc} , ΔE , and C' for signal and background for Belle

Ensemble Test Results: Belle

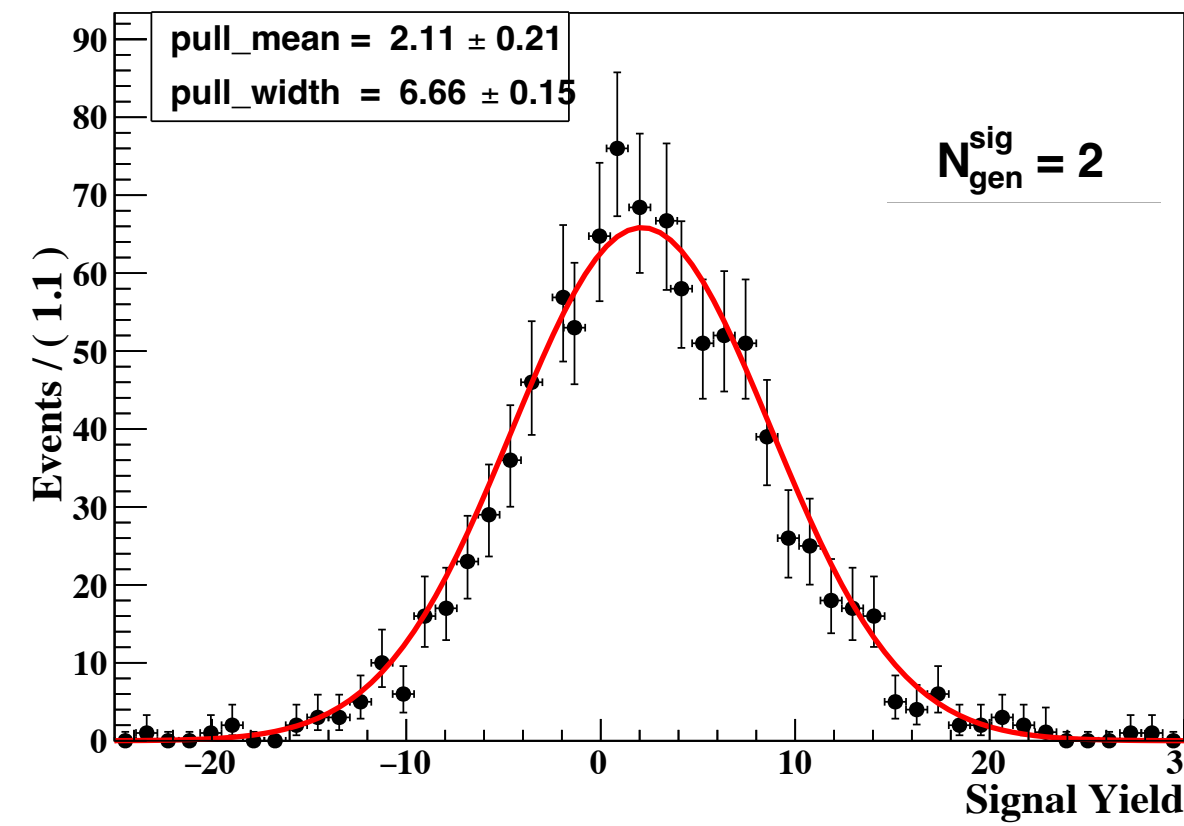
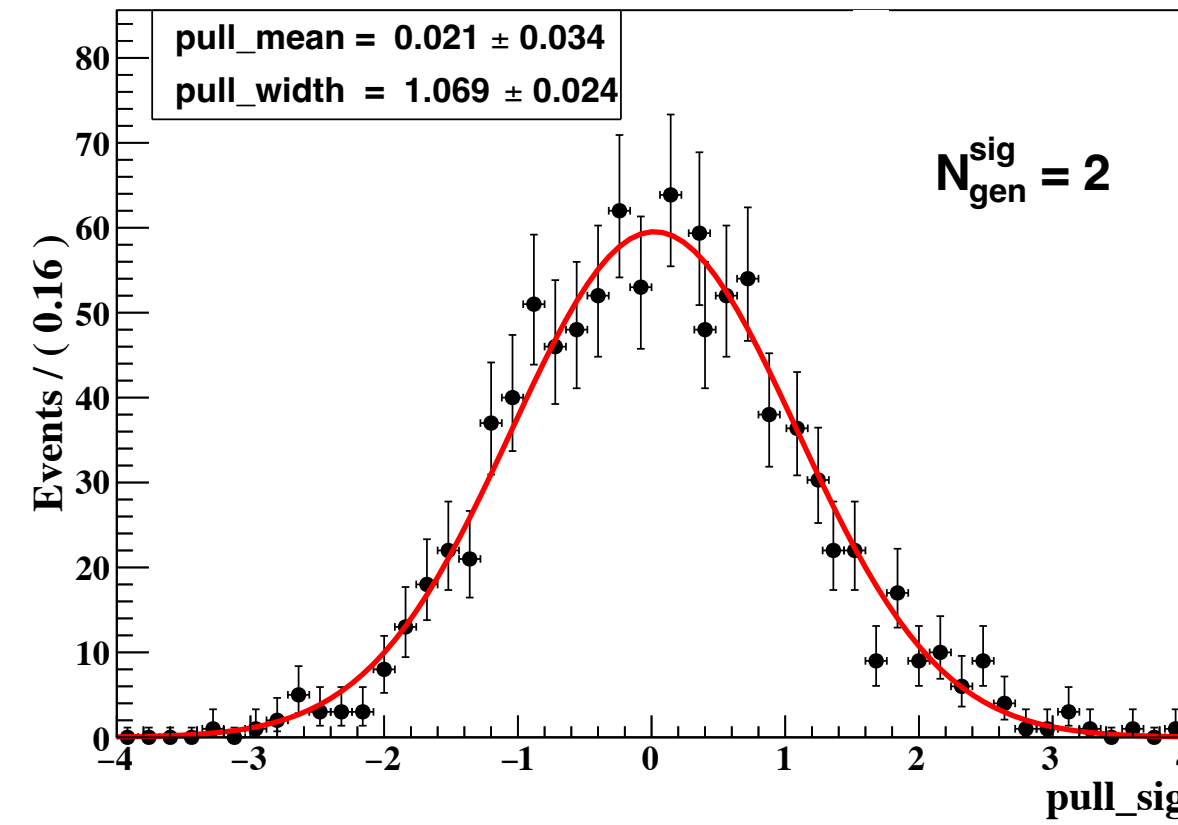

Fig: Pull (left) and signal yield (right) distribution for Belle, respectively

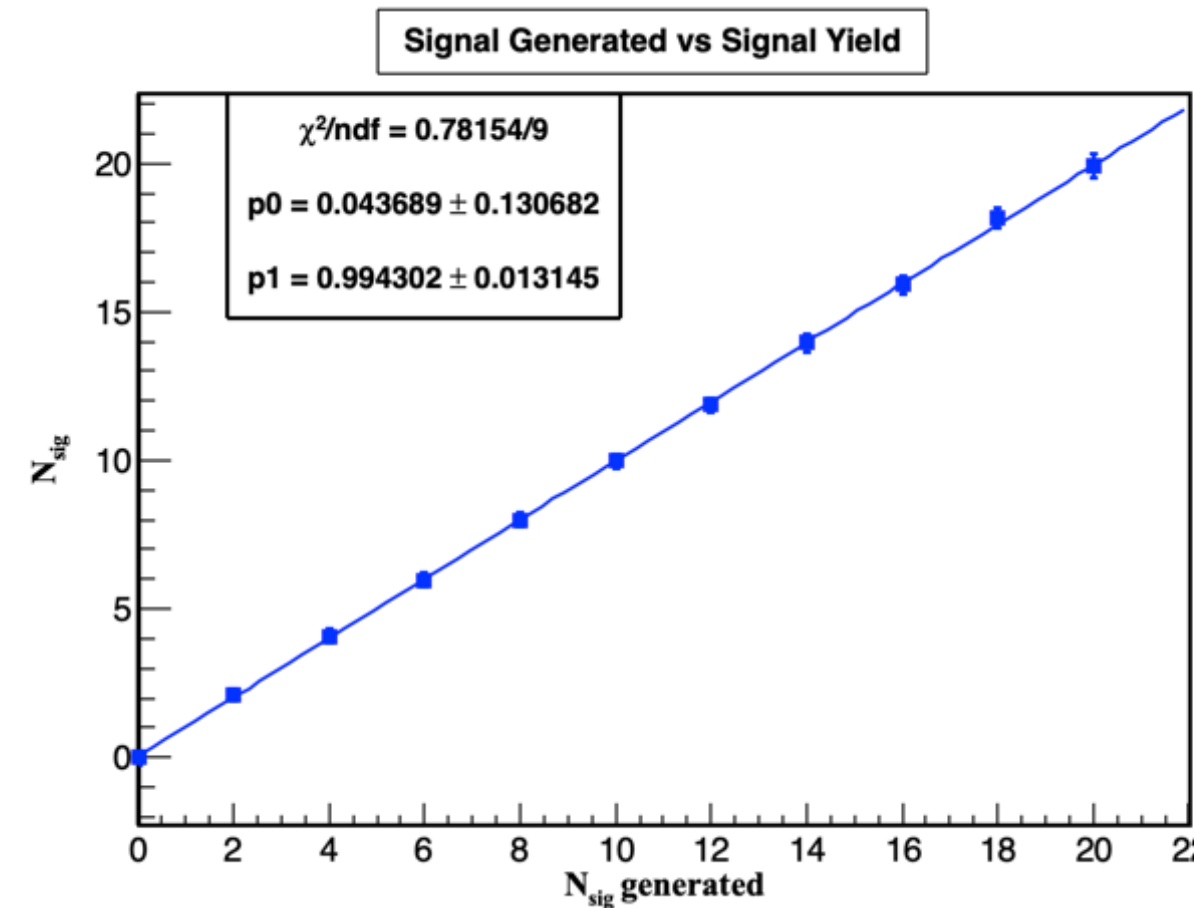
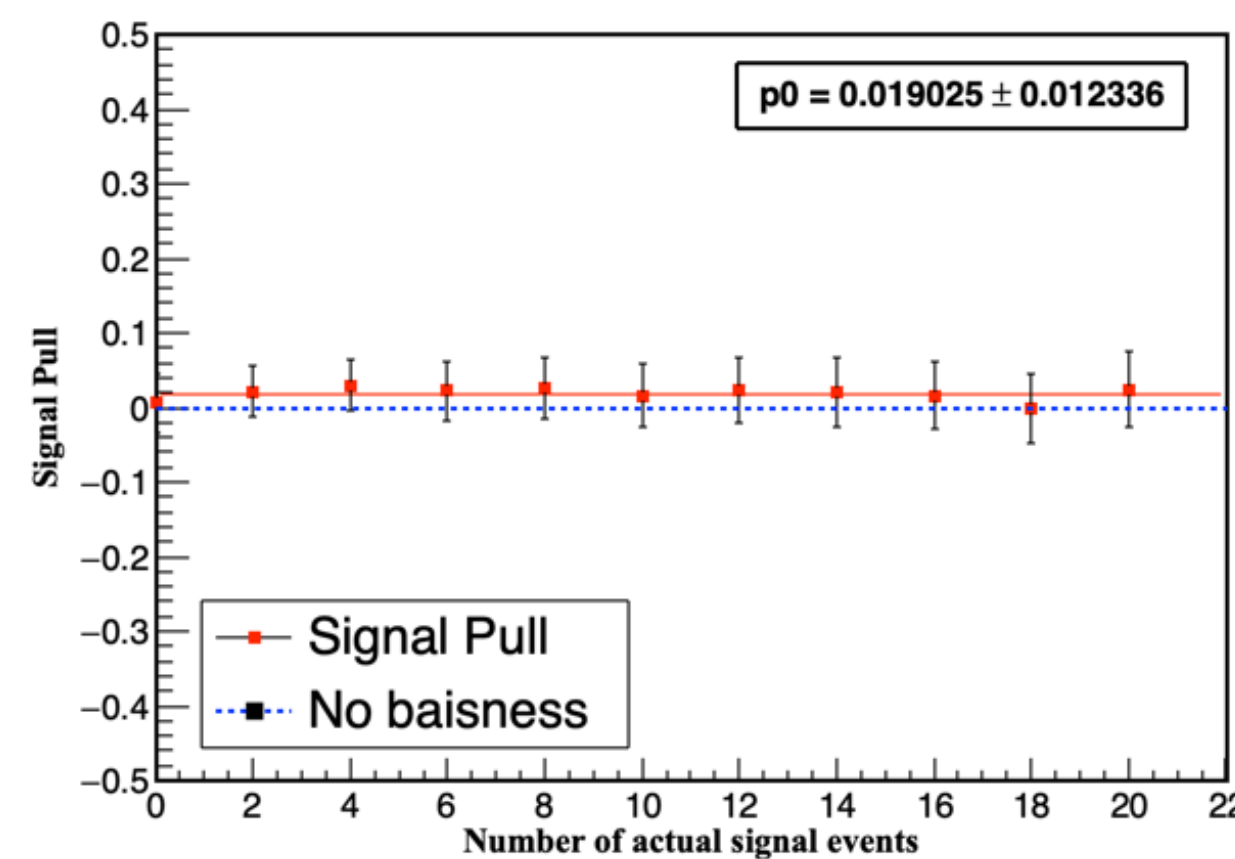

Fig: Pull vs. Nsig (left) and Linearity of the fit model (right) for Belle, respectively

- We generate 1000 such ensembles and calculate the pull for different signal yields.
- Expected signal yields in real data arbitrarily range from 0 to 20, while background events are taken from continuum MC events normalized with data luminosity.

- Gsim study shows a bias of 1.90% for Belle in the fitting strategy.
- We have assigned the combined systematic of +0.16 event from the fit bias and linearity test for Belle.

Fixed and Floated parameters for the 3D Fit model

Variable		Function	Parameter	Comment
M_{bc}	Signal	2D KDE	-	No parameter
	Background	Argus	Endpoint Curvature(argpar)	Fixed Floated
ΔE	Signal	2D KDE	-	No parameter
	Background	1 st Order Chebyshev polynomial	Coefficient(a1)	Floated
C'_{BDT}	Signal	0 th order Polynomial	-	No parameter
	Background	Exponential	λ_1 λ_2 frac	Fixed Fixed Floated

Table: PDF used in the Fit model of $B^0 \rightarrow \gamma\gamma$ sample and parameter information.

Systematic Uncertainty

Belle

Uncertainties on Signal Efficiency	Fractional uncertainties (%)
Photon Efficiency	4.00
No. of $B\bar{B}$ pairs	2.81
Timing requirement	2.80
Reconstruction Efficiency	0.57
BDT selection	0.40
π^0/η Veto	0.30
Total	5.68
Uncertainties on Signal Yield	uncertainties (events)
PDF shape Parameter	+0.56 -0.48
Fit Bias	+0.16
Signal Shape Modeling	+0.06
Total	+0.58 -0.48

Dominant sources of systematic uncertainty

- Number of $B\bar{B}$ pairs
- Photon Efficiency
- Timing requirement
- PDF shape parameter

Negligible impact on the limit

DATA-MC comparison of Belle II for $B^0 \rightarrow K^* \gamma$

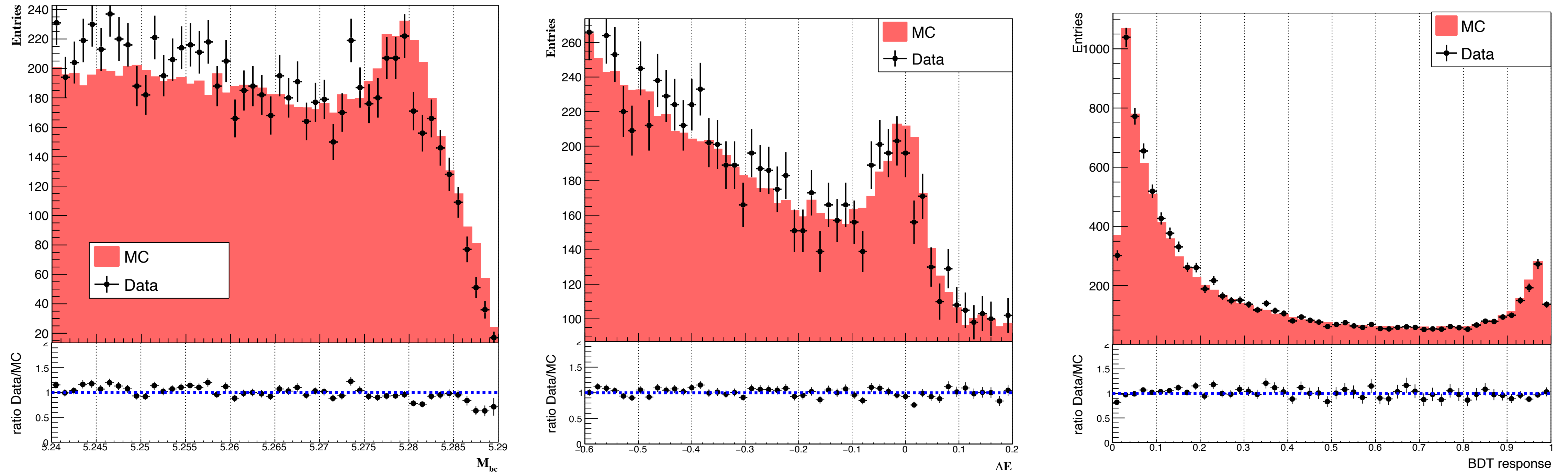

M_{bc} , ΔE and FastBDT output distributions comparing Belle II data and MC

- Overall, good Data-MC agreement.

Data-MC Comparison for FastBDT output and Eventshape Variable: Belle

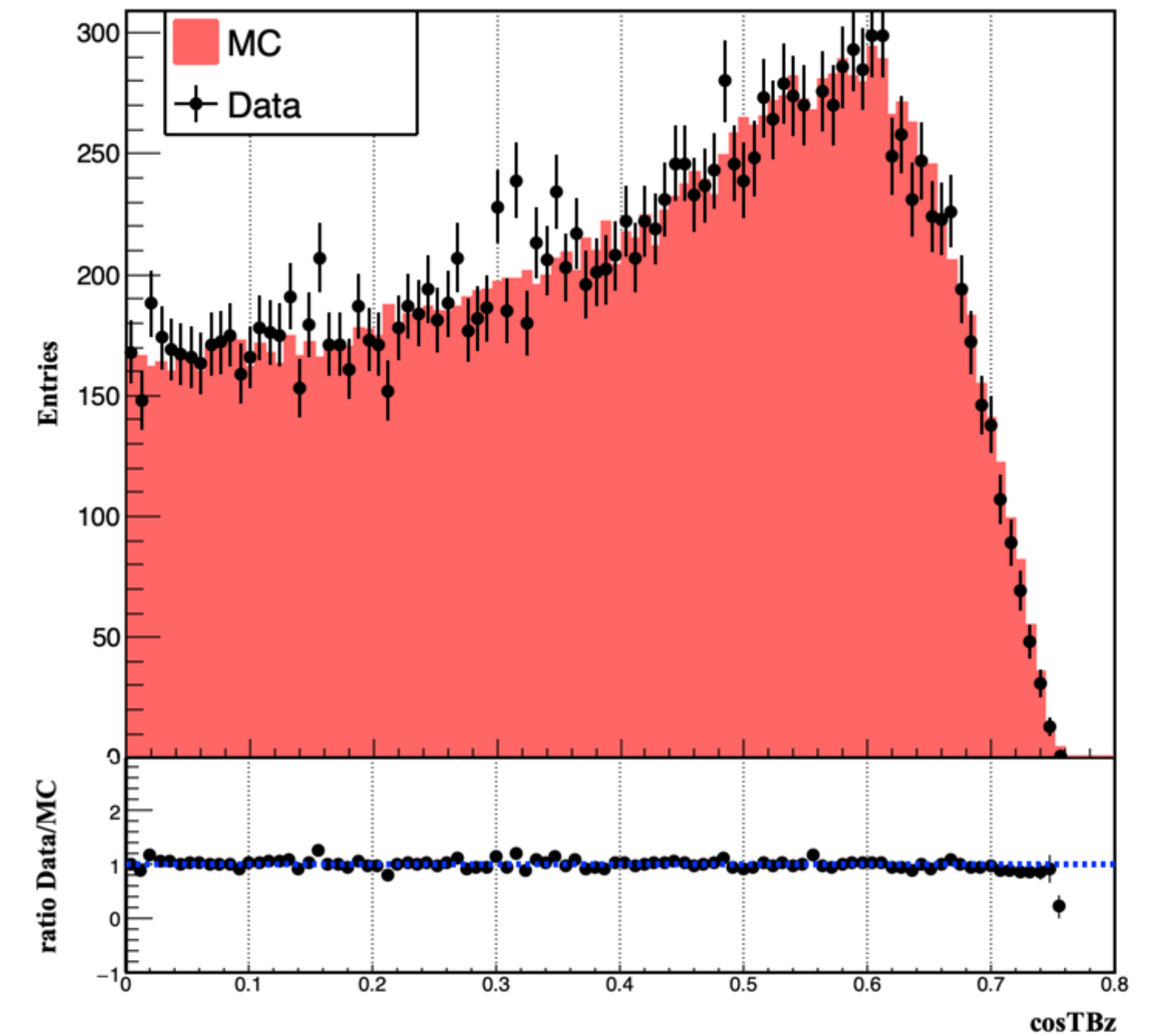
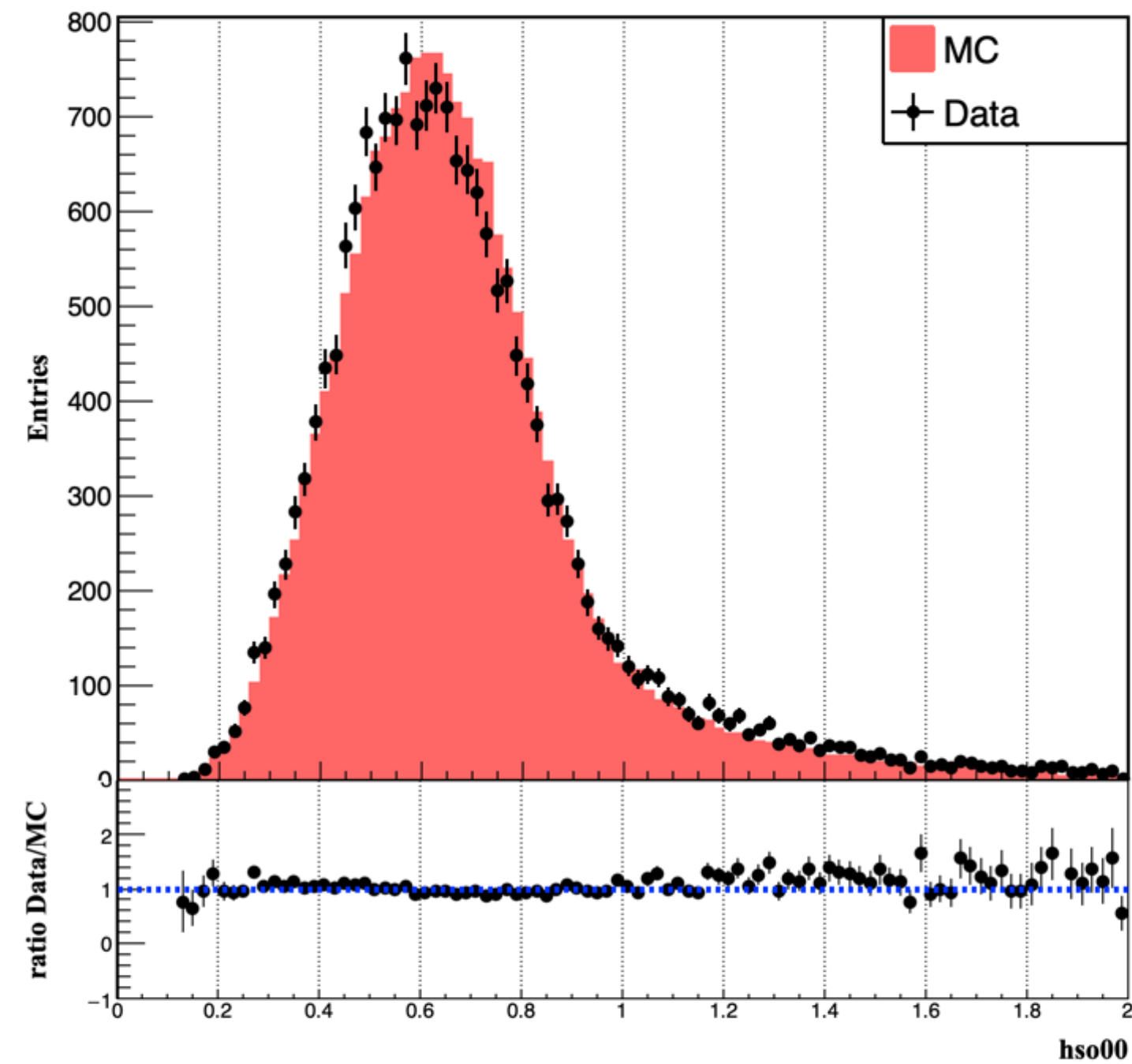
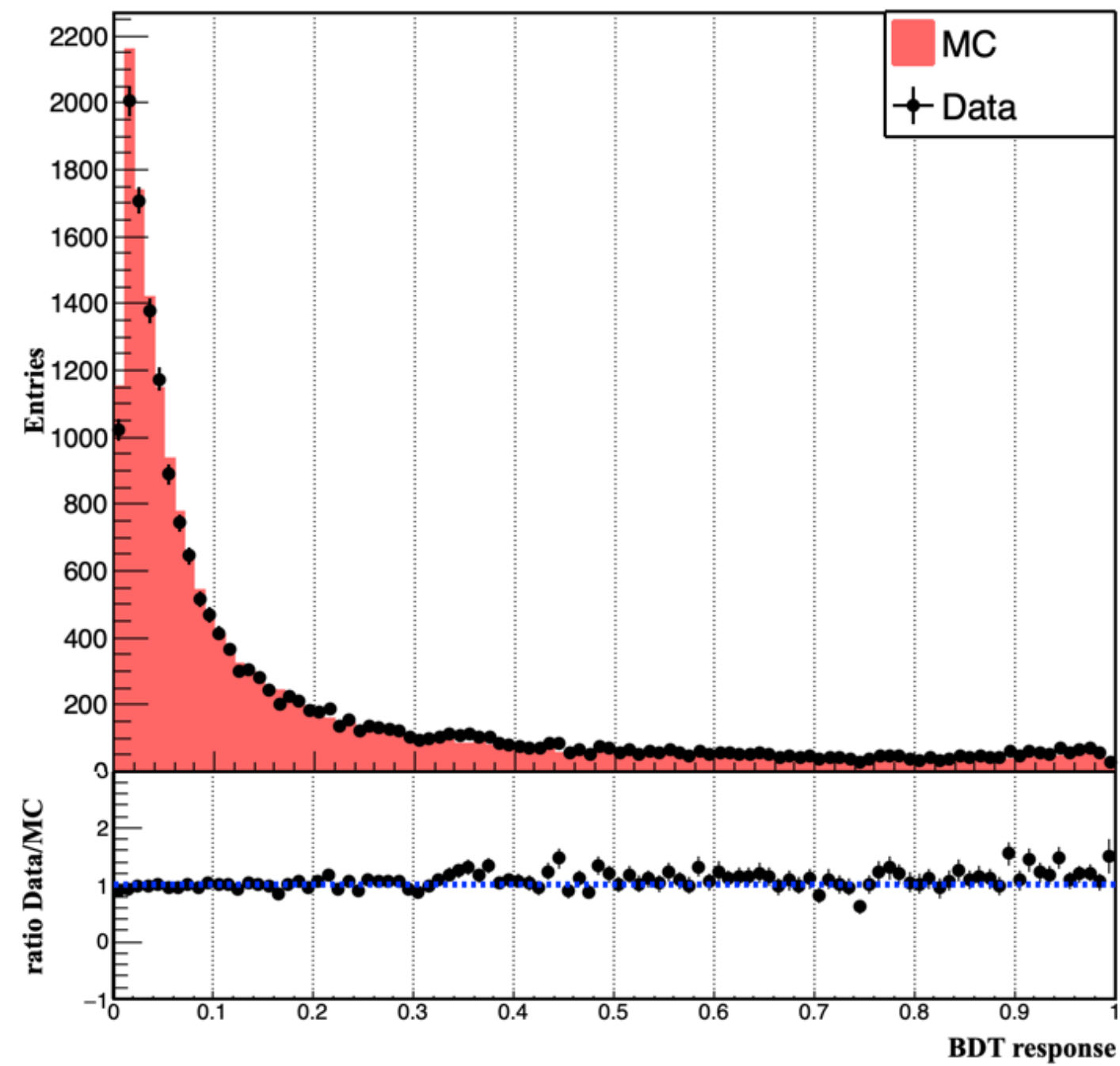

- We do not observe any serious differences in Data -MC comparison.

Uncertainty due to shape Modeling

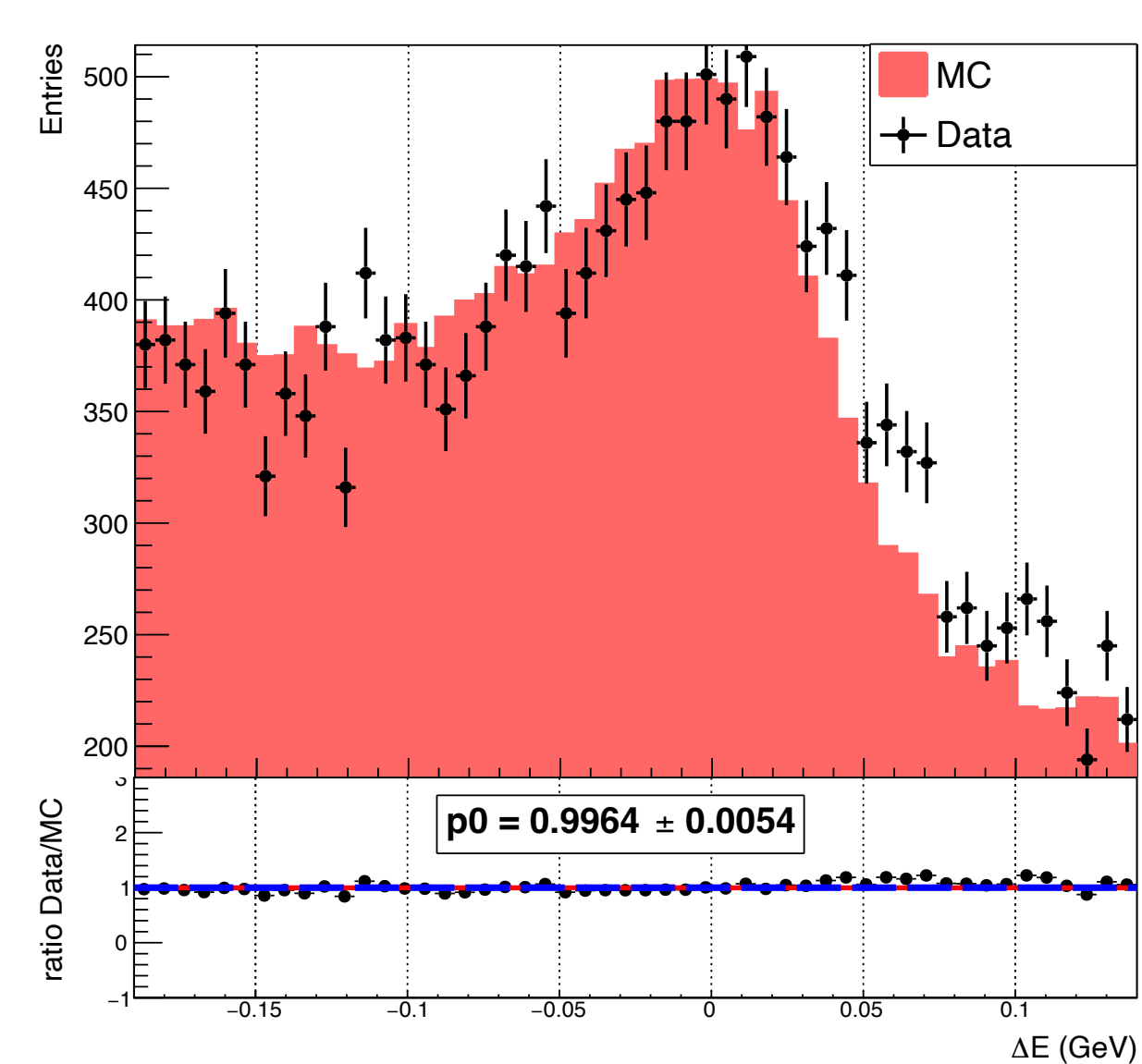
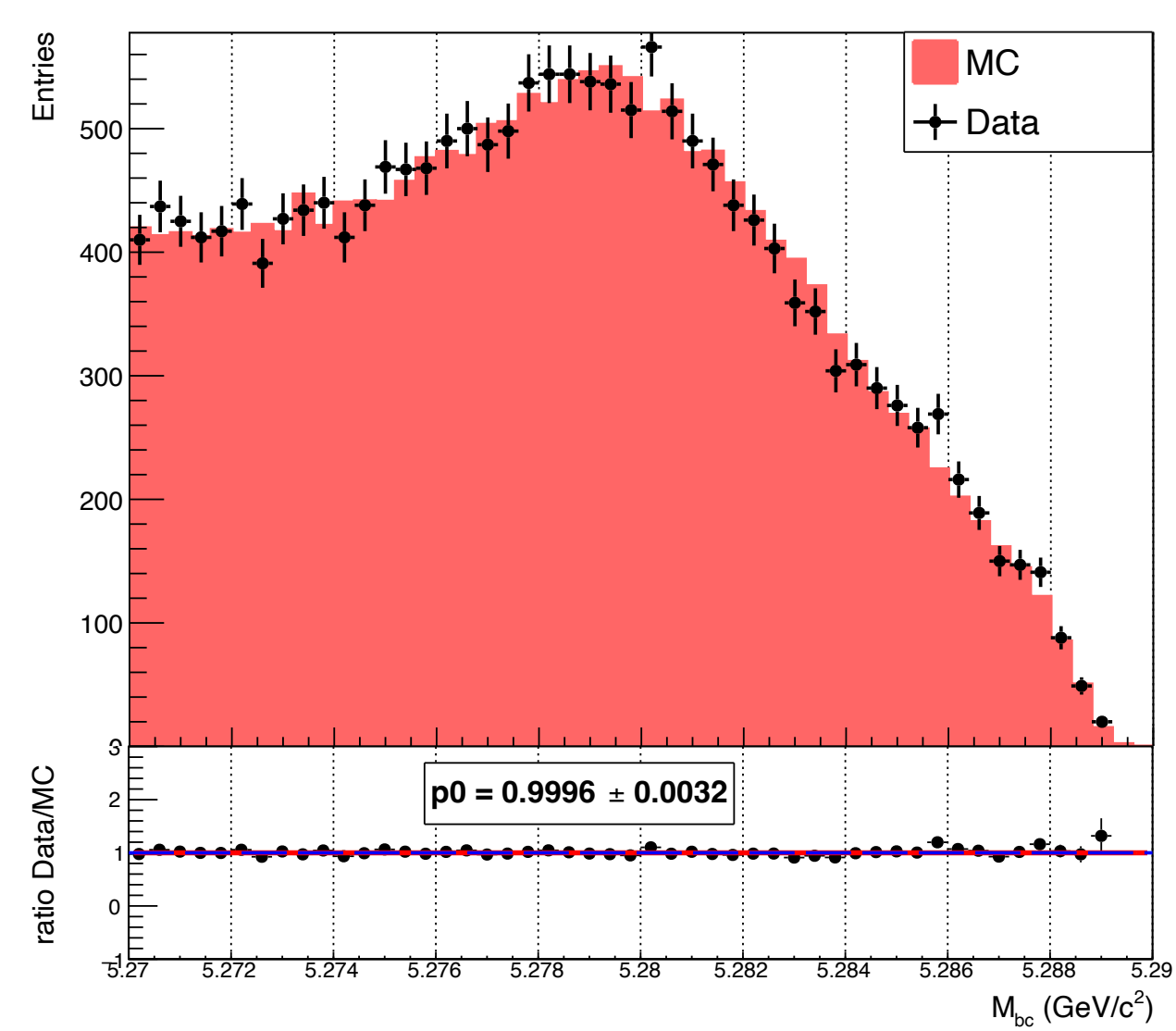
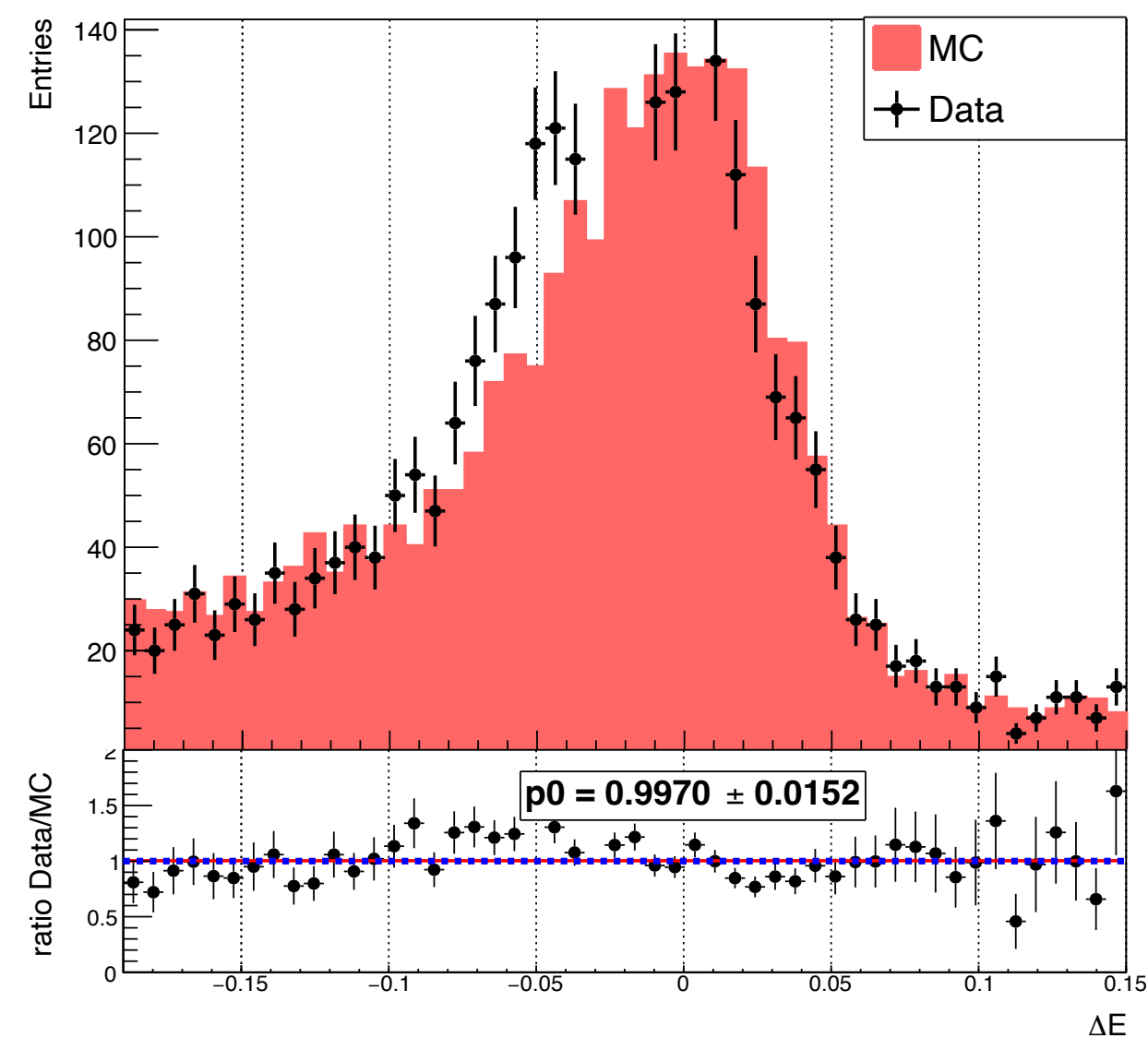
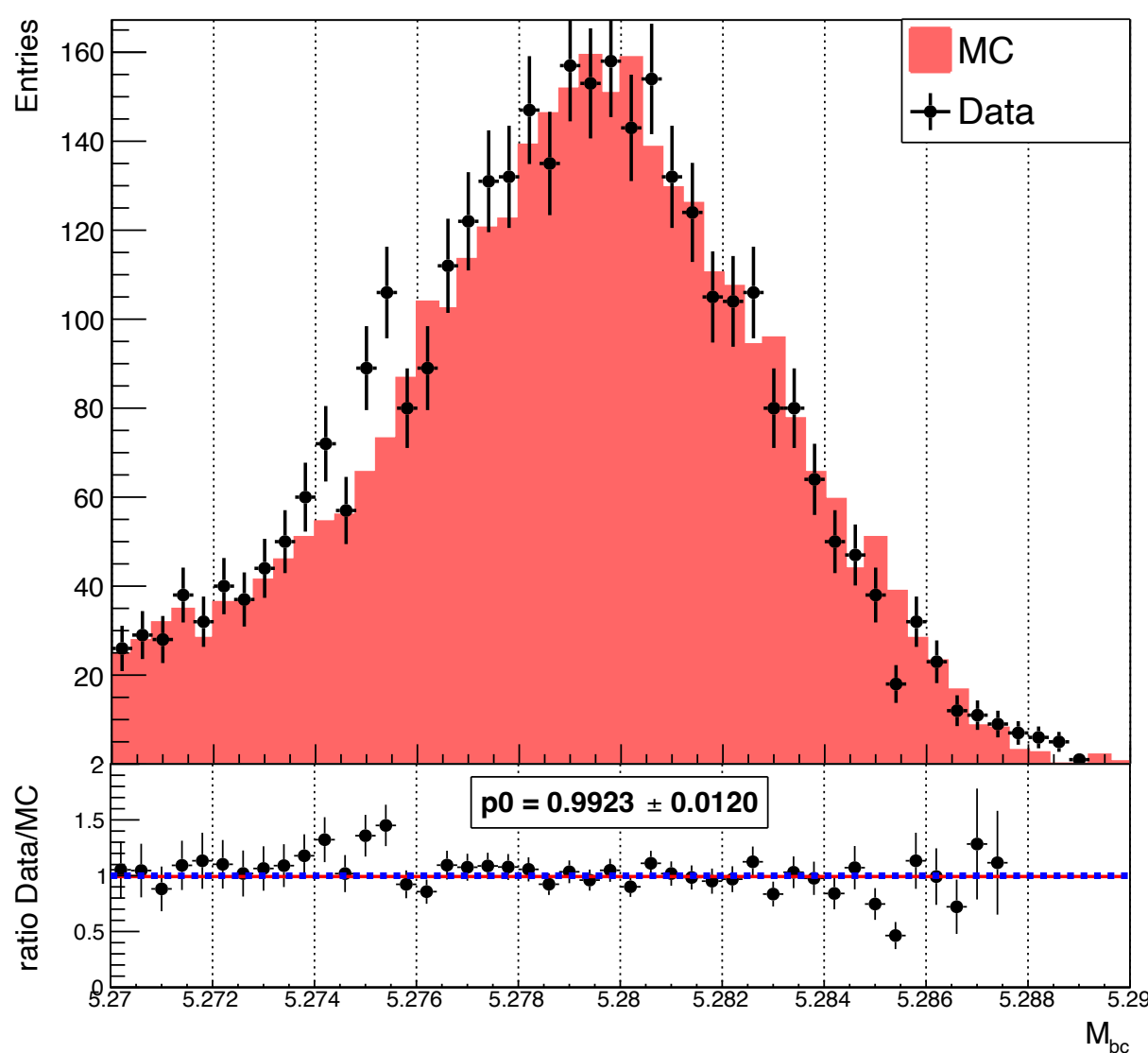

Data-MC comparison for M_{bc} and ΔE for Belle II

Data-MC comparison for M_{bc} and ΔE for Belle

- Systematic due to shape discrepancy between the Data and MC is studied using a control sample $B^0 \rightarrow K^* \gamma$.
- The deviation from the unity in the DATA/MC ratio which is 0.72% (2%) will be considered a source of systematic uncertainty for Belle (Belle II).

Timing requirement : Belle Study

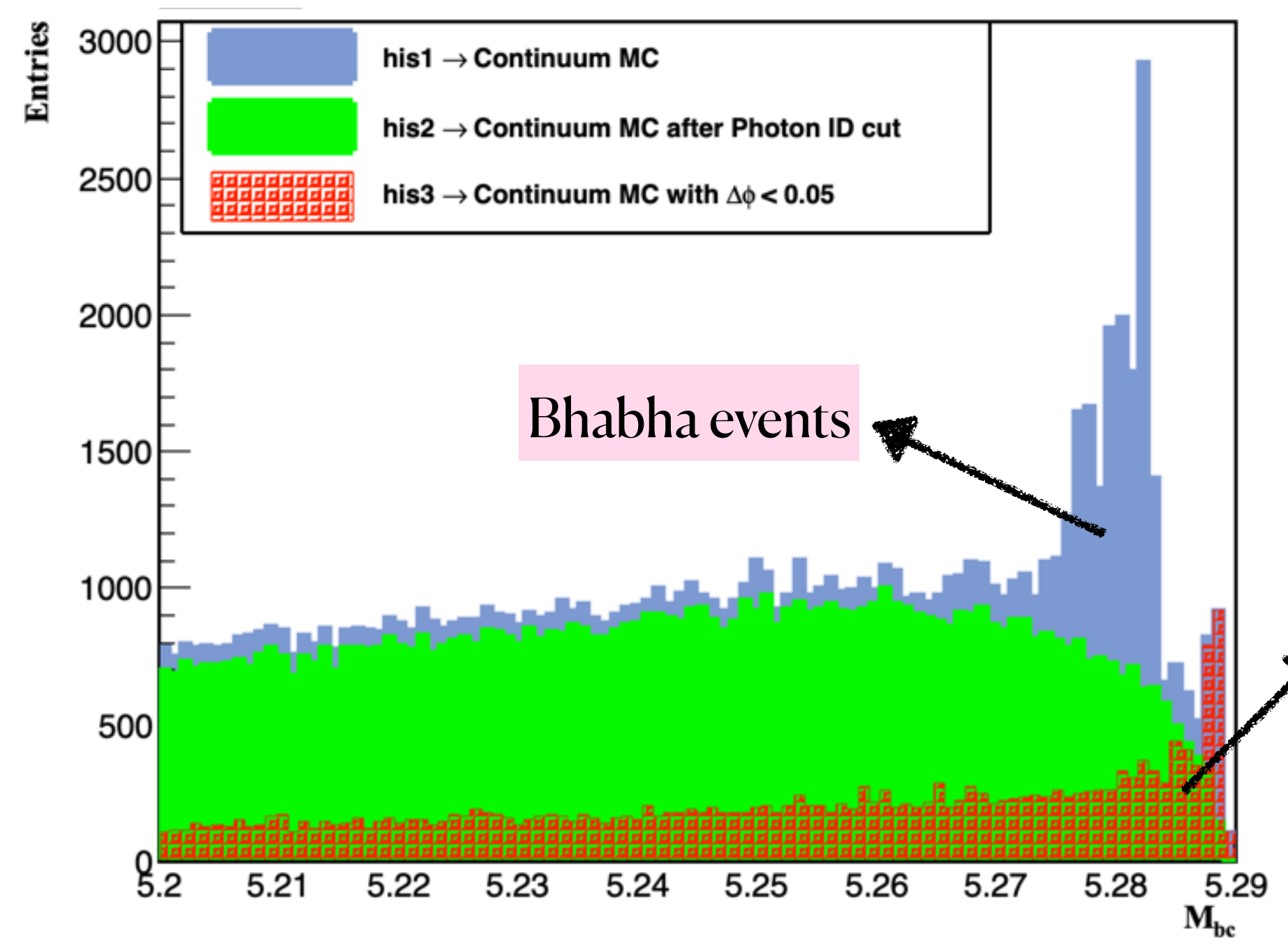

Figure 1: M_{bc} distribution for the preselected data. The hatched histogram shows the off-time events, which correspond to $e^+e^- \rightarrow \gamma\gamma$ events.

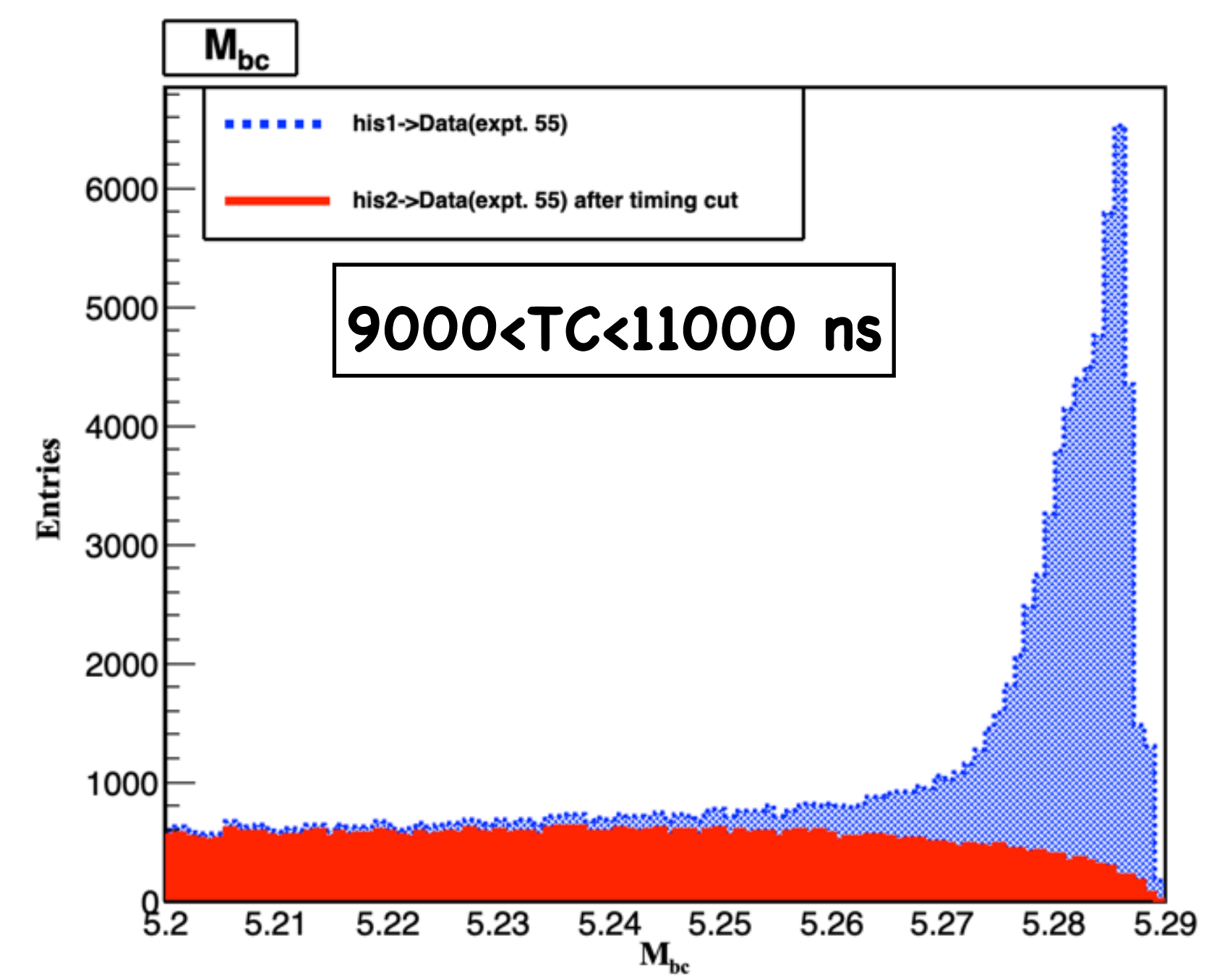

Fig 2: Peaking component rejected after applying the timing cut in real data

- Due to the overlap of a hadronic event with energy deposits in the ECL by QED processes like Bhabha events and $e^+e^- \rightarrow \gamma\gamma$ can mimic the signal events.
- The peaking effect of off-time QED backgrounds is completely removed by applying the timing criterion requiring that the photons hit the ECL clusters within 9 to 11 microseconds.