

Partial-wave analysis of $\tau^\mp \rightarrow \pi^\mp \pi^\mp \pi^\pm \nu_\tau$

Friday, December 8th, 2023



TAU2023



Searches for new particles and interactions not part of the Standard Model: need to know various hadron form-factors

- Disagreement in measurements of $a_1(1260)$ parameters ($m = 1190 \text{ MeV} - 1330 \text{ MeV}$)

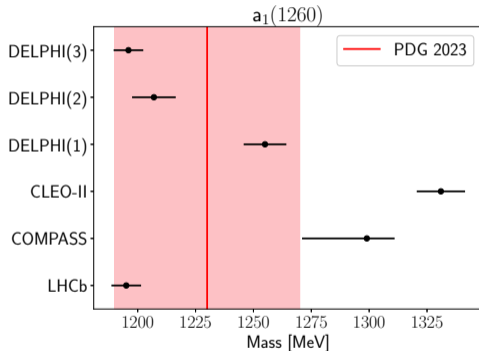

Searches for new particles and interactions not part of the Standard Model: need to know various hadron form-factors

- Disagreement in measurements of $a_1(1260)$ parameters ($m = 1190 \text{ MeV} - 1330 \text{ MeV}$)
- COMPASS observed narrow peak $a_1(1420)$ (PRL 115, 082001)
 - ▶ Isospin partner of $f_1(1420)$?
 - ▶ K^*K rescattering?

$a_1(1420)$ observation at COMPASS

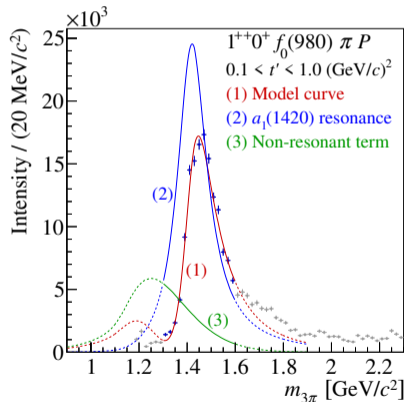

Searches for new particles and interactions not part of the Standard Model: need to know various hadron form-factors

- Disagreement in measurements of $a_1(1260)$ parameters ($m = 1190 \text{ MeV} - 1330 \text{ MeV}$)
- COMPASS observed narrow peak $a_1(1420)$ (PRL 115, 082001)
 - ▶ Isospin partner of $f_1(1420)$?
 - ▶ $K^* K$ rescattering?
- $\tau \rightarrow 3\pi \nu$ provides X-check for COMPASS 3π partial wave analysis (PWA) in different experimental conditions

$a_1(1420)$ observation at COMPASS

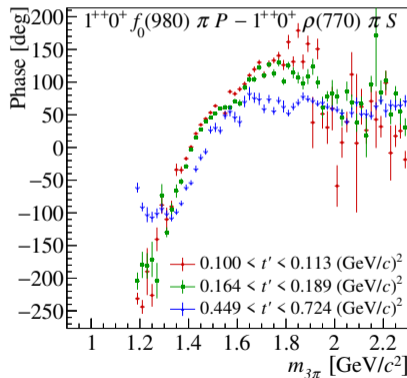

Searches for new particles and interactions not part of the Standard Model: need to know various hadron form-factors

- Disagreement in measurements of $a_1(1260)$ parameters ($m = 1190 \text{ MeV} - 1330 \text{ MeV}$)
- COMPASS observed narrow peak $a_1(1420)$ (PRL 115, 082001)
 - ▶ Isospin partner of $f_1(1420)$?
 - ▶ K^*K rescattering?
- $\tau \rightarrow 3\pi\nu$ provides X-check for COMPASS 3π partial wave analysis (PWA) in different experimental conditions

Improve current model in event generators

Only amplitude analysis in $\tau \rightarrow 3\pi\nu_\tau$:
CLEO-II PRD 61, 012002

Wave	Branching
$1^+[\rho(770)\pi]_S$	68.11%
$1^+[\sigma\pi]_P$	16.18%
$1^+[f_0(1370)\pi]_P$	4.29%
$1^+[\rho(1450)\pi]_D$	0.43%
$1^+[\rho(770)\pi]_D$	0.36%
$1^+[\rho(1450)\pi]_S$	0.30%
$1^+[f_2(1270)\pi]_P$	0.14%

Different channel ($\pi^\pm \pi^0 \pi^0$)

Searches for new particles and interactions not part of the Standard Model: need to know various hadron form-factors

- Disagreement in measurements of $a_1(1260)$ parameters ($m = 1190 \text{ MeV} - 1330 \text{ MeV}$)
- COMPASS observed narrow peak $a_1(1420)$ (PRL 115, 082001)
 - ▶ Isospin partner of $f_1(1420)$?
 - ▶ K^*K rescattering?
- $\tau \rightarrow 3\pi\nu$ provides X-check for COMPASS 3π partial wave analysis (PWA) in different experimental conditions

Improve current model in event generators

Only amplitude analysis in $\tau \rightarrow 3\pi\nu_\tau$:
CLEO-II PRD 61, 012002

Wave	Branching
$1^+[\rho(770)\pi]_S$	68.11%
$1^+[\sigma\pi]_P$	16.18%
$1^+[f_0(1370)\pi]_P$	4.29%
$1^+[\rho(1450)\pi]_D$	0.43%
$1^+[\rho(770)\pi]_D$	0.36%
$1^+[\rho(1450)\pi]_S$	0.30%
$1^+[f_2(1270)\pi]_P$	0.14%

Same $a_1(1260)$ shape in all states

Searches for new particles and interactions not part of the Standard Model: need to know various hadron form-factors

- Disagreement in measurements of $a_1(1260)$ parameters ($m = 1190 \text{ MeV} - 1330 \text{ MeV}$)
- COMPASS observed narrow peak $a_1(1420)$ (PRL 115, 082001)
 - ▶ Isospin partner of $f_1(1420)$?
 - ▶ K^*K rescattering?
- $\tau \rightarrow 3\pi\nu$ provides X-check for COMPASS 3π partial wave analysis (PWA) in different experimental conditions

Improve current model in event generators

Only amplitude analysis in $\tau \rightarrow 3\pi\nu_\tau$:
CLEO-II PRD 61, 012002

Wave	Branching
$1^+[\rho(770)\pi]_S$	68.11%
$1^+[\sigma\pi]_P$	16.18%
$1^+[f_0(1370)\pi]_P$	4.29%
$1^+[\rho(1450)\pi]_D$	0.43%
$1^+[\rho(770)\pi]_D$	0.36%
$1^+[\rho(1450)\pi]_S$	0.30%
$1^+[f_2(1270)\pi]_P$	0.14%

No $1^+[f_0(980)\pi]_P$ wave discovered

KEKB was asymmetric e^+e^- collider

$$E_{e^+} = 3.5 \text{ GeV}, E_{e^-} = 8 \text{ GeV}$$

Total luminosity: 980 fb^{-1}

- $\Upsilon(4S)$: 711 fb^{-1}
- 0.9×10^9 tauon pairs produced

Tauon:

- $m = 1.777 \text{ GeV}$
- $c\tau = 86 \mu\text{m}$
- $\mathcal{B}(\tau^\mp \rightarrow \pi^\mp \pi^\mp \pi^\pm \nu_\tau) = 9\%$

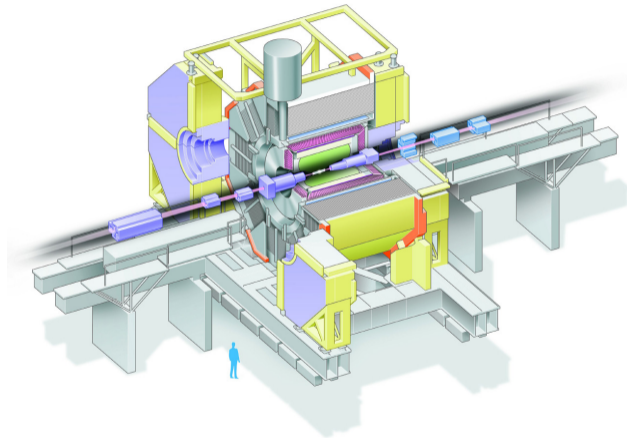

Belle detector

	PRD 81 113007	Current
Efficiency	22 %	32 %
Purity	89 %	82 %
# of events	9×10^6	55×10^6
Tag	μ^\pm or e^\pm	1-prong

Main background components:

$$\tau^\mp \rightarrow \pi^\mp \pi^\mp \pi^\pm \pi^0 (\pi^0) \nu_\tau \quad 12.8 \%$$

$$e^+ e^- \rightarrow q \bar{q} \quad 4 \%$$

$$\tau^\mp \rightarrow K^\mp \pi^\mp \pi^\pm \nu_\tau \quad 1 \%$$

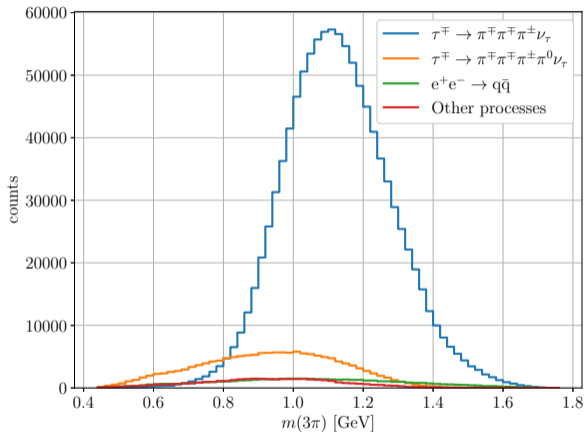

7D phase space

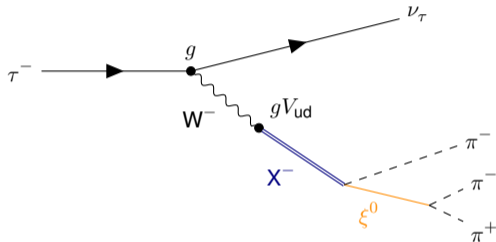

7D phase space

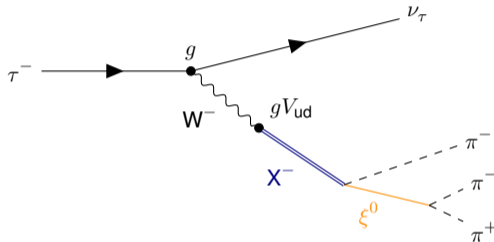

Average intensity over tauon azimuthal angle

7D phase space

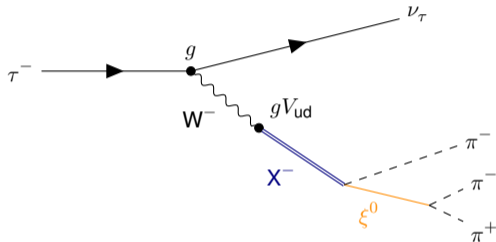

Average intensity over tauon azimuthal angle

Decompose hadron current J_{had}^μ into partial waves (EPJC 81 12, 1073)

7D phase space

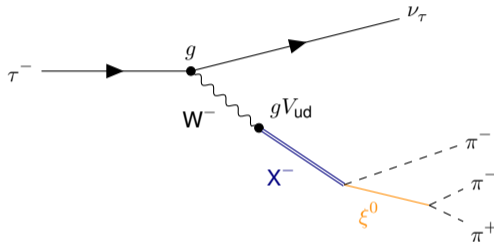

Average intensity over tauon azimuthal angle

Decompose hadron current J_{had}^μ into partial waves (EPJC 81 12, 1073): $J_{\text{had}}^\mu = \sum_w C_w j_w^\mu$,

7D phase space

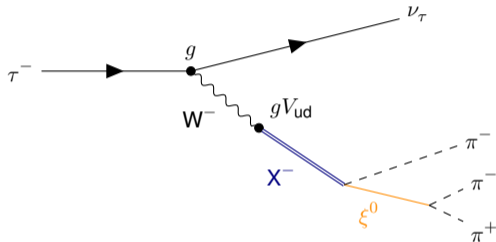

Average intensity over tauon azimuthal angle

Decompose hadron current J_{had}^μ into partial waves (EPJC 81 12, 1073): $J_{\text{had}}^\mu = \sum_w C_w j_w^\mu$,

C_w partial-wave coefficients

7D phase space

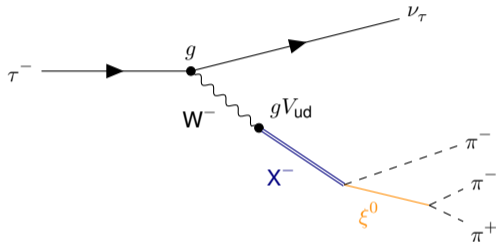

Average intensity over tauon azimuthal angle

Decompose hadron current J_{had}^μ into partial waves (EPJC 81 12, 1073): $J_{\text{had}}^\mu = \sum_w C_w j_w^\mu$,

j_w^μ are fixed, quantum numbers $J^P[\xi^0 \pi]_L$, 16 partial waves

7D phase space

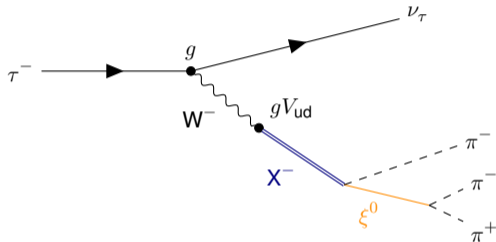

Average intensity over tauon azimuthal angle

Decompose hadron current J_{had}^μ into partial waves (EPJC 81 12, 1073): $J_{\text{had}}^\mu = \sum_w C_w J_w^\mu$,

$J^P[\xi^0 \pi]_L$: L angular momentum between ξ^0 and bachelor π^- , $L = S, P, D$ or F

Conventional PWA:

- Isobars shape is fixed
- Fit in bins of $m_{3\pi}$ (no a_1 shape assumptions)
- $2 \times N_{PW} - 1$ free parameters (\Re and \Im of C_w)
- Anchor wave: $\Im C_w = 0$
(usually $1^+[\rho(770)\pi]_S$ wave)

Intensity:

$$\mathcal{I} = \sum_{w,v} C_w C_v^* \mathcal{I}_{wv}$$

$$\mathcal{I}_{wv} = \overline{\mathcal{L}_{\mu\nu}} j_w^\mu (j_v^\nu)^*$$

Extended log likelihood function:

$$\ln \mathcal{L} = \sum_{\text{Data}} \ln \sum_{w,v} C_w C_v^* \mathcal{I}_{wv} - \sum_{w,v} C_w C_v^* \mathcal{N}_{wv}$$

Integral matrix:

$$\mathcal{N}_{wv} = \frac{\sum_{\text{Acc MC}} \mathcal{I}_{wv} / |\mathcal{M}_{\text{TAUOLA}}|^2}{\sum_{\text{Acc MC}} 1 / |\mathcal{M}_{\text{TAUOLA}}|^2}$$

Partial wave	Fit fraction [%]
$1^+ [\rho(770)\pi]_S$	97.37
$1^+ [\sigma\pi]_P$	11.57
$1^+ [\rho(770)\pi]_D$	2.48
$1^+ [\rho(1450)\pi]_S$	1.77
$1^+ [f_0(980)\pi]_P$	0.41
$1^+ [f_2(1270)\pi]_P$	0.11
$1^+ [f_0(1370)\pi]_P$	0.06
$1^+ [f_2(1270)\pi]_F$	0.02
$1^+ [\rho(1450)\pi]_D$	0.01
$1^+ [f_0(1500)\pi]_P$	0.00
$0^- [\rho(770)\pi]_P$	0.36
$0^- [\sigma\pi]_S$	0.26
$0^- [f_2(1270)\pi]_D$	0.02
$0^- [f_0(980)\pi]_S$	0.01

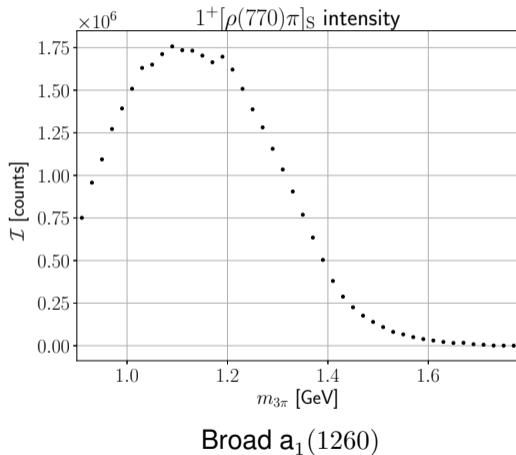

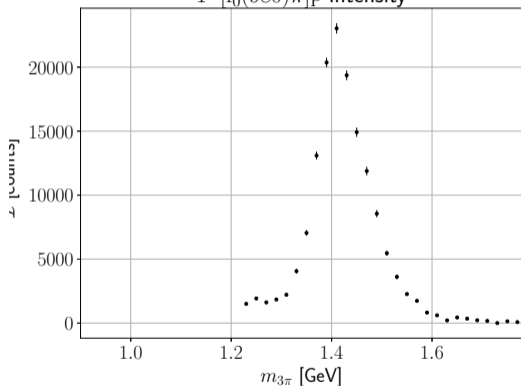
$1^+ [f_0(980)\pi]_P$ intensity

Narrow peak at 1.4 GeV

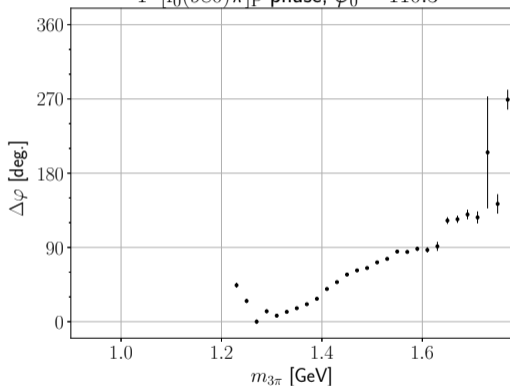
 $1^+ [f_0(980)\pi]_P$ phase, $\varphi_0 = 110.3^\circ$

Phase rise at 1.4 GeV

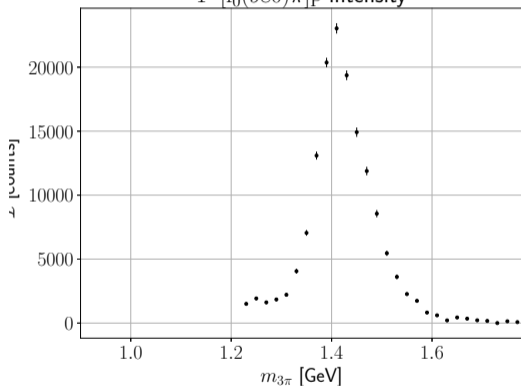
$1^+ [f_0(980)\pi]_P$ intensity

Narrow peak at 1.4 GeV

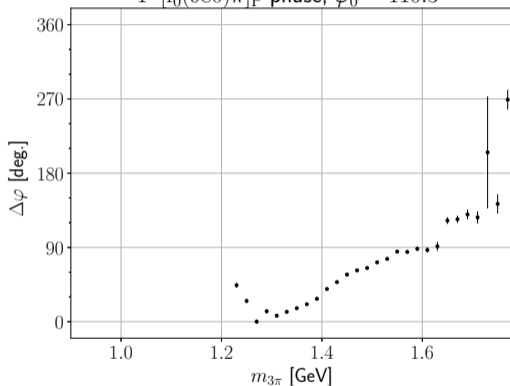
 $1^+ [f_0(980)\pi]_P$ phase, $\varphi_0 = 110.3^\circ$

Phase rise at 1.4 GeV

Conventional PWA:

- Isobar's shape $\Delta(s)$ is fixed with a model
- One complex coefficient C_w per wave

Breit-Wigner (BW) parametrization (for example):

$$\Delta_\xi(s) = \text{BW}_\xi(s) = \frac{m_\xi^2}{m_\xi^2 - s - i\sqrt{s}\Gamma(s)}$$

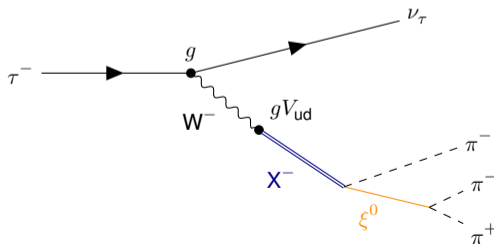

Freed-isobar PWA: look at two-pion spectrum

$$\Delta(s) = \sum_{w \text{ freed}} C_{w \text{ freed}} \Theta_w(s)$$

$$\Theta_w(s) = \begin{cases} 1 & \text{if } s \text{ in the } m_{2\pi} \text{ bin } w \\ 0 & \text{otherwise} \end{cases}$$

$1^{--} m(2\pi)$ binning:

$$\begin{cases} 2 \text{ MeV} & [770, 792] \text{ MeV} \\ 20 \text{ MeV} & [640, 920] \text{ MeV} \\ 40 \text{ MeV} & \text{otherwise} \end{cases}$$

Freed-isobar PWA: look at two-pion spectrum

$$\Delta(s) = \sum_{w \text{ freed}} C_{w \text{ freed}} \Theta_w(s)$$

$$\Theta_w(s) = \begin{cases} 1 & \text{if } s \text{ in the } m_{2\pi} \text{ bin } w \\ 0 & \text{otherwise} \end{cases}$$

0^{++} $m(2\pi)$ binning:

$$\begin{cases} 10 \text{ MeV} & [920, 1080] \text{ MeV} \\ 40 \text{ MeV} & \text{otherwise} \end{cases}$$

Freed-isobar PWA: look at two-pion spectrum

$$\Delta(s) = \sum_{w \text{ freed}} C_{w \text{ freed}} \Theta_w(s)$$

$$\Theta_w(s) = \begin{cases} 1 & \text{if } s \text{ in the } m_{2\pi} \text{ bin } w \\ 0 & \text{otherwise} \end{cases}$$

Mathematical ambiguities (zero modes)

10.1103/PhysRevD.97.114008

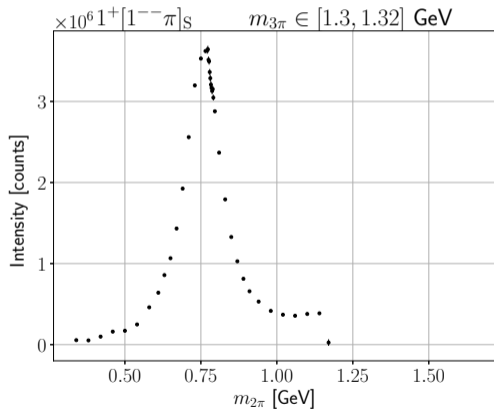
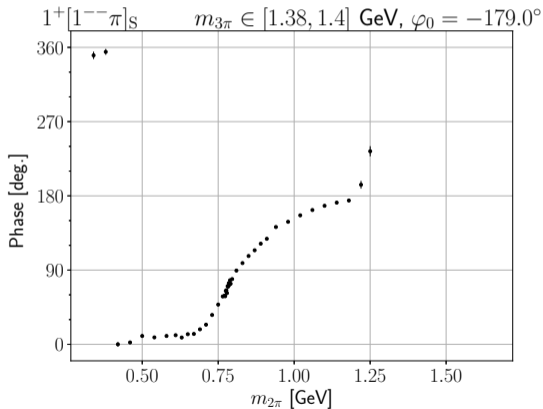
Clear $\rho(770)$ peak

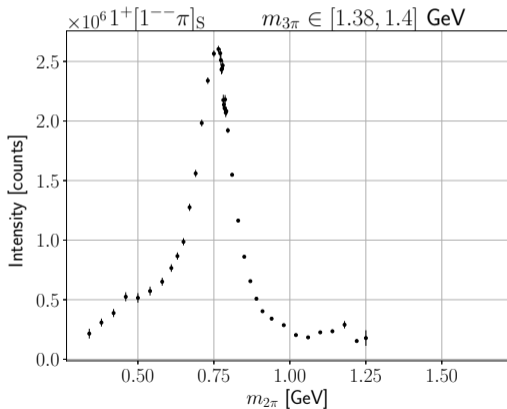
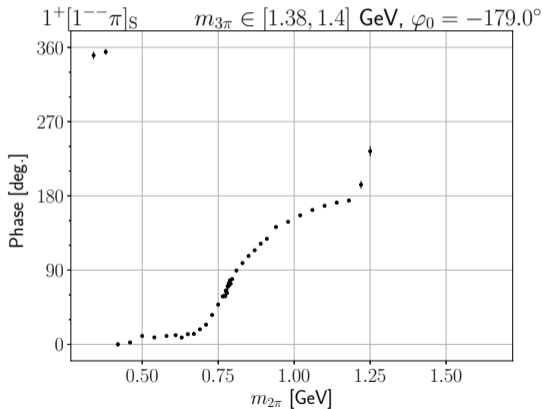
 Clear $\rho(770)$ phase rise

Clear $\rho(770)$ peak

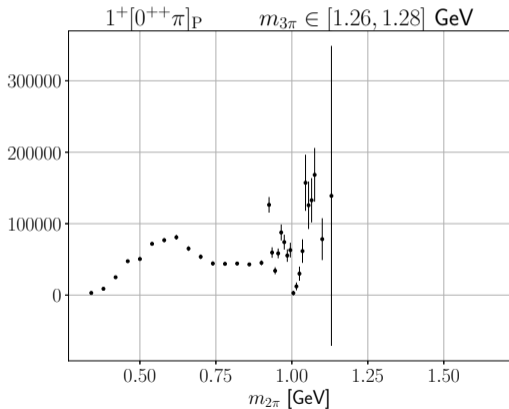
 Clear $\rho(770)$ phase rise

No $f_0(980)$ peak

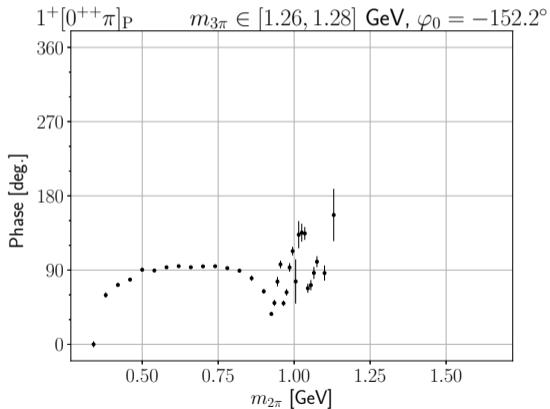

No $f_0(980)$ phase rise

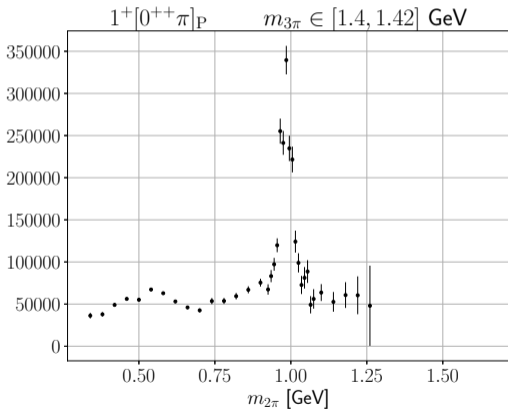
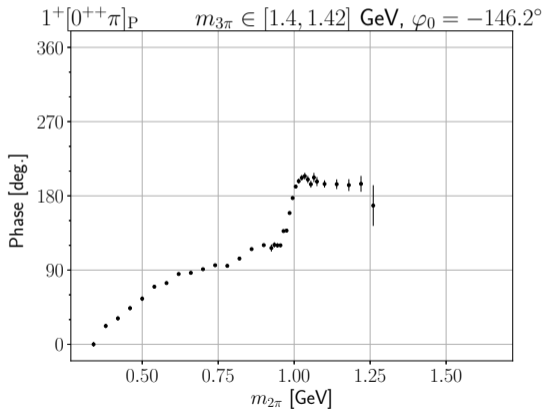

Clear narrow $f_0(980)$ peak

 Clear $f_0(980)$ phase rise

No $f_0(980)$ peak

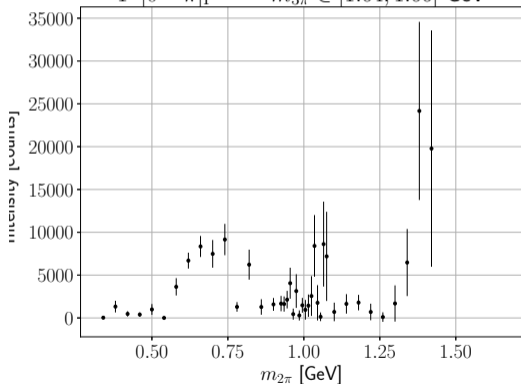
$1^+[0^{++}\pi]_P$ $m_{3\pi} \in [1.64, 1.66]$ GeV



No $f_0(980)$ phase rise

$1^+[0^{++}\pi]_P$ $m_{3\pi} \in [1.64, 1.66]$ GeV, $\varphi_0 = -179.1^\circ$

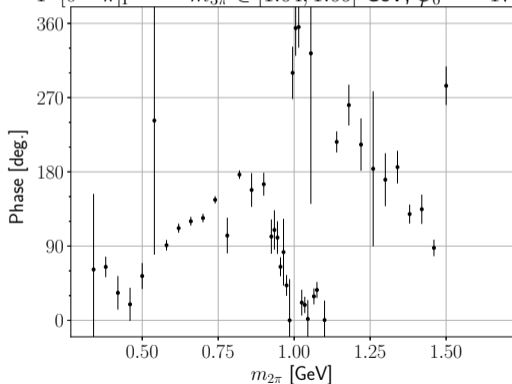

Quantum number $G \cdot P \cdot (-1)^J = 1$ for first-class, -1 for second-class currents

Quantum number $G \cdot P \cdot (-1)^J = 1$ for first-class, -1 for second-class currents

Is $J^P = 1^-$ second-class current in $\tau^- \rightarrow \pi^- \pi^- \pi^+ \nu_\tau$?

Quantum number $G \cdot P \cdot (-1)^J = 1$ for first-class, -1 for second-class currents

Is $J^P = 1^-$ second-class current in $\tau^- \rightarrow \pi^- \pi^- \pi^+ \nu_\tau$?

Not necessarily: $\omega(782) \rightarrow \pi^+ \pi^-$ violates G-parity ($\mathcal{B} = 1.5\%$)

Quantum number $G \cdot P \cdot (-1)^J = 1$ for first-class, -1 for second-class currents

Is $J^P = 1^-$ second-class current in $\tau^- \rightarrow \pi^- \pi^- \pi^+ \nu_\tau$?

Not necessarily: $\omega(782) \rightarrow \pi^+ \pi^-$ violates G-parity ($\mathcal{B} = 1.5\%$)

Source of $\omega(782)$?

Quantum number $G \cdot P \cdot (-1)^J = 1$ for first-class, -1 for second-class currents

Is $J^P = 1^-$ second-class current in $\tau^- \rightarrow \pi^- \pi^- \pi^+ \nu_\tau$?

Not necessarily: $\omega(782) \rightarrow \pi^+ \pi^-$ violates G-parity ($\mathcal{B} = 1.5\%$)

Source of $\omega(782)$? $\tau \rightarrow \rho' \nu_\tau$

Quantum number $G \cdot P \cdot (-1)^J = 1$ for first-class, -1 for second-class currents

Is $J^P = 1^-$ second-class current in $\tau^- \rightarrow \pi^- \pi^- \pi^+ \nu_\tau$?

Not necessarily: $\omega(782) \rightarrow \pi^+ \pi^-$ violates G-parity ($\mathcal{B} = 1.5\%$)

Source of $\omega(782)$? $\tau \rightarrow \rho' \nu_\tau$, $\rho' \rightarrow \omega(782) \pi$

Quantum number $G \cdot P \cdot (-1)^J = 1$ for first-class, -1 for second-class currents

Is $J^P = 1^-$ second-class current in $\tau^- \rightarrow \pi^- \pi^- \pi^+ \nu_\tau$?

Not necessarily: $\omega(782) \rightarrow \pi^+ \pi^-$ violates G-parity ($\mathcal{B} = 1.5\%$)

Source of $\omega(782)$? $\tau \rightarrow \rho' \nu_\tau$, $\rho' \rightarrow \omega(782)\pi$, $\omega(782) \rightarrow \pi^+ \pi^-$

Quantum number $G \cdot P \cdot (-1)^J = 1$ for first-class, -1 for second-class currents

Is $J^P = 1^-$ second-class current in $\tau^- \rightarrow \pi^- \pi^- \pi^+ \nu_\tau$?

Not necessarily: $\omega(782) \rightarrow \pi^+ \pi^-$ violates G-parity ($\mathcal{B} = 1.5\%$)

Source of $\omega(782)$? $\tau \rightarrow \rho' \nu_\tau$, $\rho' \rightarrow \omega(782)\pi$, $\omega(782) \rightarrow \pi^+ \pi^-$

$$\frac{\mathcal{B}(\tau^- \rightarrow \omega \pi^- \nu_\tau)}{\mathcal{B}(\tau^- \rightarrow \pi^- \pi^- \pi^+ \nu_\tau)} = 22\%$$

Quantum number $G \cdot P \cdot (-1)^J = 1$ for first-class, -1 for second-class currents

Is $J^P = 1^-$ second-class current in $\tau^- \rightarrow \pi^- \pi^- \pi^+ \nu_\tau$?

Not necessarily: $\omega(782) \rightarrow \pi^+ \pi^-$ violates G-parity ($\mathcal{B} = 1.5\%$)

Source of $\omega(782)$? $\tau \rightarrow \rho' \nu_\tau$, $\rho' \rightarrow \omega(782)\pi$, $\omega(782) \rightarrow \pi^+ \pi^-$

$$\frac{\mathcal{B}(\tau^- \rightarrow \omega \pi^- \nu_\tau)}{\mathcal{B}(\tau^- \rightarrow \pi^- \pi^- \pi^+ \nu_\tau)} = 22\%$$

Expected fit fraction of $1^-[\omega(782)\pi]_P = 0.3\%$

Clear $\omega(782)$ phase peak

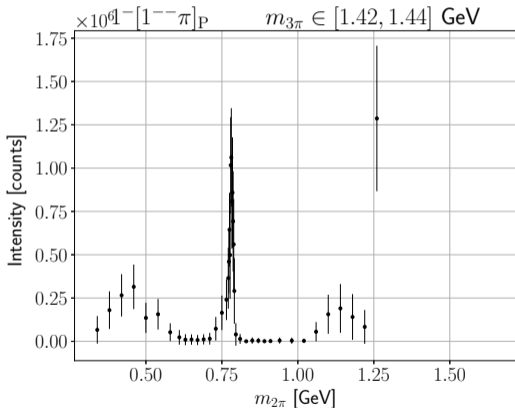

Clear $\omega(782)$ phase rise

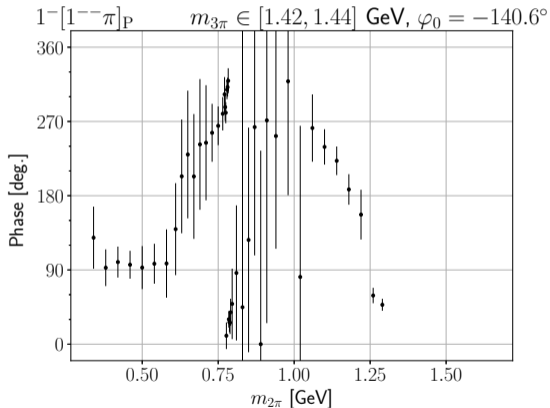

Clear $\omega(782)$ phase peak

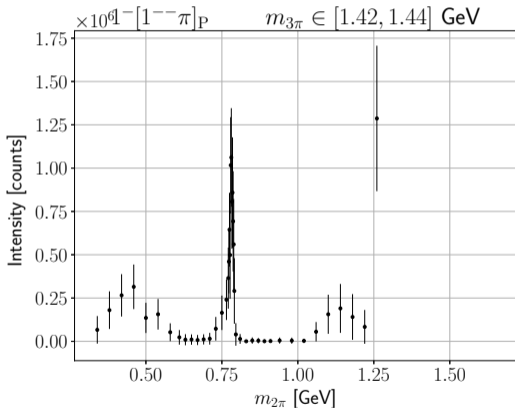

Clear $\omega(782)$ phase rise

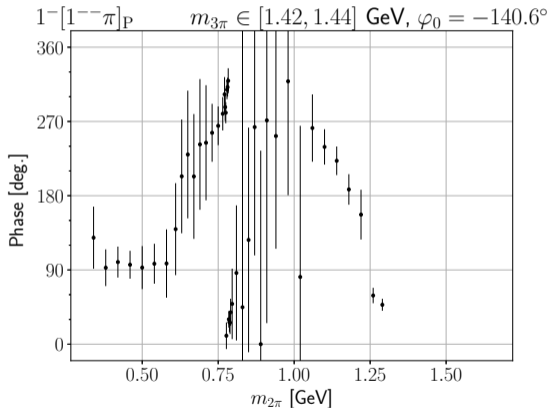

Add $1^- [\omega(782)\pi]_P$ wave to the wave set

Broad structure peaking at 1.4 GeV

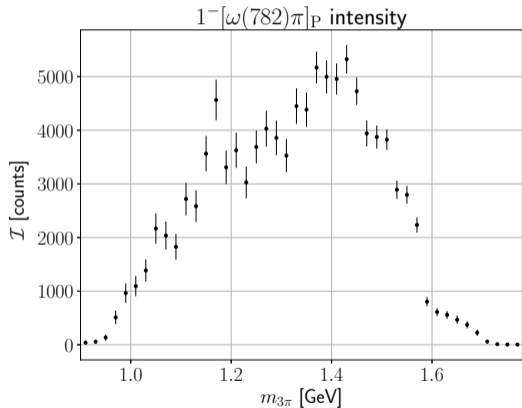
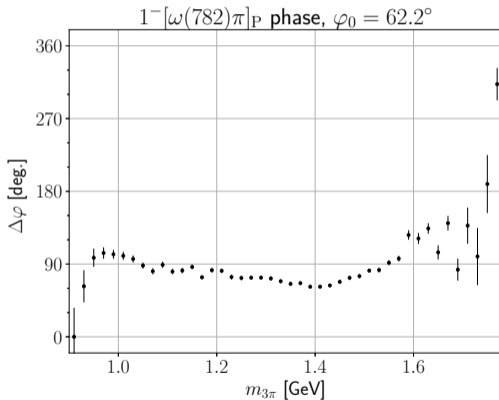
 $\phi(1^- [\omega(782)\pi]_P) - \phi(1^+ [\rho(770)\pi]_S)$

This analysis

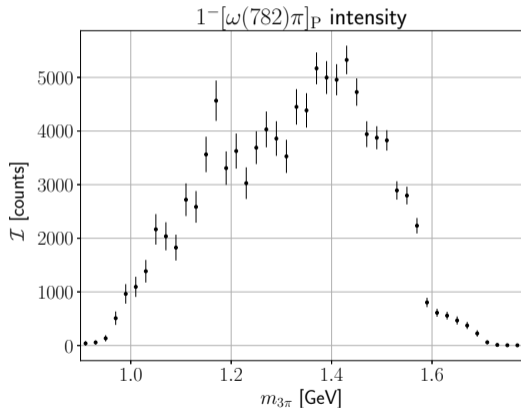

$m_{\omega\pi^-}$ for $\tau^- \rightarrow \omega\pi^- \nu_\tau$ (PRD 61 072003)

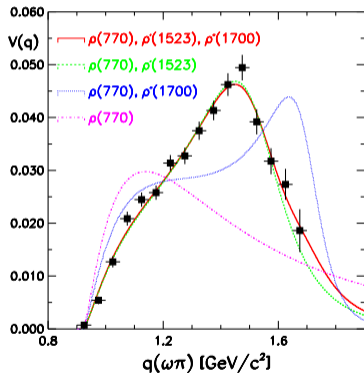

Current status:

- Selection criteria
- Partial-wave decomposition
 - ▶ Fixed-isobar
 - ▶ Freed-isobar
- Resonance-model and isobar fits
- Systematic uncertainties:
 - ▶ Model
 - ▶ Background
 - ▶ Acceptance
 - ▶ Resolution

Results:

- $a_1(1420)$ discovered
- $1^-[\omega(782)\pi]_P$ wave observed

Remaining systematic studies:

- Trigger
- PID

 Future projects for $\tau^- \rightarrow \pi^- \pi^- \pi^+ \nu_\tau$

- G-parity violation in $J^P = 1^-$ w/o $\omega(782)$
- CP-asymmetry



Backup

Event-class selection

- Standard Belle selection for tauon pairs
- Topology: 3–1
- Boosted Decision Tree

Signal hemisphere

- Tracks identification:
 - ▶ Veto signal-side particles being electrons or muons
 - ▶ Veto the like-sign signal-side particles being kaons
- Veto pions coming from K_0 : $|m_{2\pi} - m_{K_S}| < 12 \text{ MeV}$
- Veto π^0 s in signal hemisphere: $\sum E_\gamma < 480 \text{ MeV}$

Good tracks selection:

- $|\Delta r| < 0.5 \text{ cm}$
- $|\Delta z| < 2.5 \text{ cm}$
- $p_{\perp} > 0.1 \text{ GeV}$

Good photons selection:

- $E_{\gamma} > 0.04 \text{ GeV}$
- $w > 0.5 \text{ cm}$
- $N_{\text{hits}} > 2$
- $E_{\text{seed}}/E_{\text{cluster}} < 0.95$

Preselection: four good tracks with sum charge zero

Skimming:

- tau_skimB or HadronBJ
- BDT response $b_{\tau\tau} > 0$

Topology: 3 + 1

Loose π^0 -veto in signal hemisphere:
 $\sum E_{\gamma} < 0.48 \text{ GeV}$

Signal tracks PID:

- three tracks: e-veto, μ -veto
- two tracks same charge: K-veto

K_S -veto in signal hemisphere:

$$\left| m_{2\pi} - m_{K_S} \right| < 0.012 \text{ GeV}$$

Sequential efficiencies and purities:

Criterion	purity [%]	efficiency [%]
baseline	22.1	44.4
trig	23.1	43.8
skim	24.5	43.1
BDT	50.6	39.9
LID	54.0	37.8
HID	57.4	36.7
PHS	57.7	36.7
ISR	58.2	35.9
KS_veto	60.7	34.3
pi0_veto	81.6	32.3

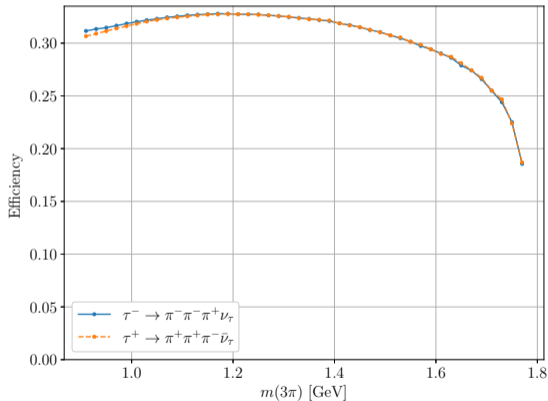

$m(3\pi)$ efficiency

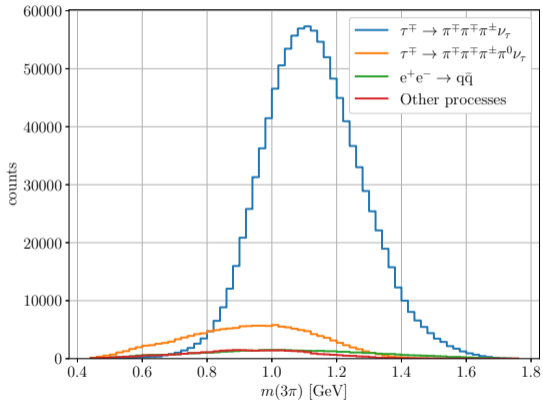

$m(3\pi)$ spectrum in MC

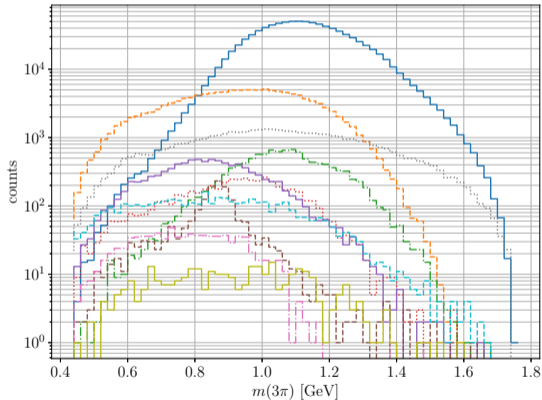

$m(3\pi)$ spectrum in MC, logOY

Partial-wave
decompositon in 5D

Resonance-model
fit in 1D

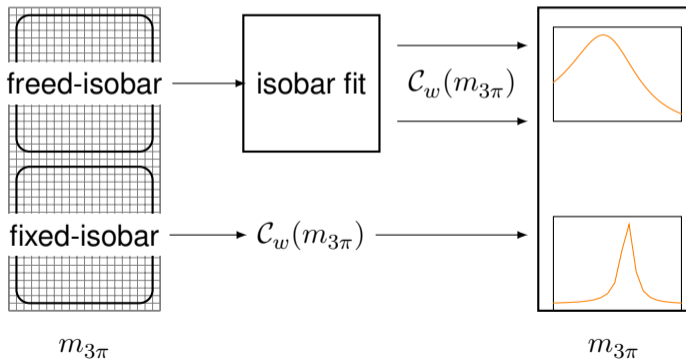

Conventional PWA:

- Isobars shape is fixed
- Fit in bins of $m_{3\pi}$ (no a_1 shape assumptions)
- $2 \times N_{PW} - 1$ free parameters: partial-waves complex coefficients C_w (one phase is fixed)

Intensity:

$$\mathcal{I} = \sum_{w,v} C_w C_v^* \mathcal{I}_{wv}$$

$$\mathcal{I}_{wv} = \overline{\mathcal{L}_{\mu\nu}} j_w^\mu (j_v^\nu)^*$$

Extended log likelihood function:

$$\ln \mathcal{L} = \sum_{\text{Data}} \ln \sum_{w,v} C_w C_v^* \mathcal{I}_{wv} - \sum_{w,v} C_w C_v^* \mathcal{N}_{wv}$$

Integral matrix:

$$\mathcal{N}_{wv} = \frac{\sum_{\text{Acc MC}} \mathcal{I}_{wv} / |\mathcal{M}_{\text{MC Generator}}|^2}{\sum_{\text{Acc MC}} 1 / |\mathcal{M}_{\text{MC Generator}}|^2}$$

$|\mathcal{M}_{\text{MC Generator}}|^2$ TAUOLA intensity (CLEO current for $\tau \rightarrow 3\pi\nu_\tau$)

Partial wave	$m(\xi)$ [GeV]	$\Gamma(\xi)$ [GeV]	Threshold [GeV]
$1^+ [\sigma\pi]_P$	Broad $[\pi\pi]_S$-wave component*		
$1^+ [f_0(980)\pi]_P$	0.990	0.07	1.22
$1^+ [f_0(1500)\pi]_P$	1.504	0.109	1.64
$1^+ [\rho(770)\pi]_S$	0.769	0.1509	—
$1^+ [\rho(770)\pi]_D$			—
$1^+ [\rho(1450)\pi]_S$	1.465	0.40	1.18
$1^+ [\rho(1450)\pi]_D$			1.34
$1^+ [f_2(1270)\pi]_P$	1.2755	0.1867	1.4
$1^+ [f_2(1270)\pi]_F$			1.44
$0^- [\sigma\pi]_S$			—
$0^- [f_0(980)\pi]_S$			1.14
$0^- [\rho(770)\pi]_P$			—
$0^- [f_2(1270)\pi]_D$			1.0

Partial wave	Threshold [GeV]
$1^- [\omega(782)\pi]_P$	—
$1^- [\rho(770)\pi]_P$	0.96
$1^- [f_2(1270)\pi]_D$	—

G-parity violating waves

$$G = (-1)^I C = (-1)^{J+L+I}$$

Slice of $m_{3\pi} \in [1.50, 1.52]$ GeV

Fit to 20% L_{int} data and simulate

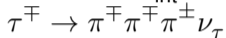

Plot legend:

- Black dots: data
- Blue hist: Fit prediction with TAUOLA-m
- Orange hist: background

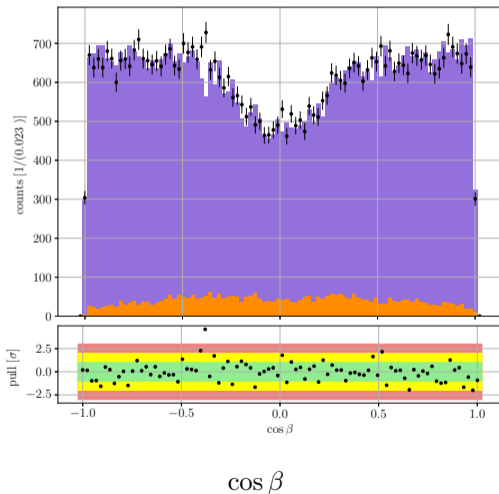

Slice of $m_{3\pi} \in [1.50, 1.52]$ GeV

Fit to 20% L_{int} data and simulate

$$\tau^{\mp} \rightarrow \pi^{\mp} \pi^{\mp} \pi^{\pm} \nu_{\tau}$$

Plot legend:

- Black dots: data
- Blue hist: Fit prediction with TAUOLA-m
- Orange hist: background

Data overshoots simulation at the $\rho(770)$ peak position

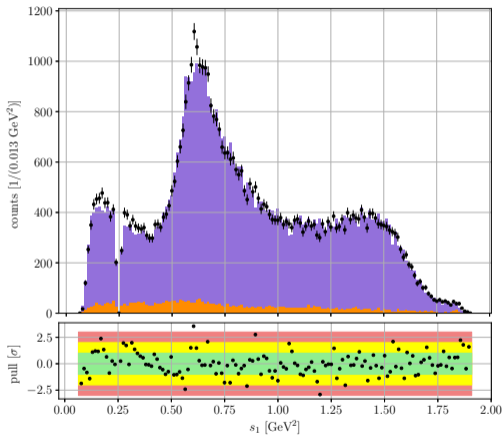

s_1 [GeV²]

Partial wave	\mathbb{B} [%]
$1^- [f_2(1270)\pi]_D$	0.46
$1^- [\omega(782)\pi]_P$	0.30
$1^- [\rho(770)\pi]_P$	0.12

F takes into the finite size of a meson

Each partial wave is multiplied by two F 's corresponding to either X^- or ξ^0

F_S for ξ^0 depends on the break-up momentum in the rest frame of ξ^0

F_L for X^- depends on the break-up momentum in the rest frame of X^-

There are two alternative parametrizations for F , I use the relativistic one, for example for a P wave

$$F_P(x) = \sqrt{\frac{1-x_0}{1-x}}, \quad x = (pd)^2$$

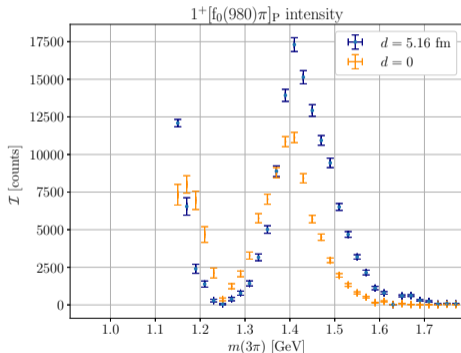

F takes into the finite size of a meson

Each partial wave is multiplied by two F s corresponding to either X^- or ξ^0

F_S for ξ^0 depends on the break-up momentum in the rest frame of ξ^0

F_L for X^- depends on the break-up momentum in the rest frame of X^-

There are two alternative parametrizations for F , I use the relativistic one, for example for a P wave

$$F_P(x) = \sqrt{\frac{1-x_0}{1-x}}, \quad x = (pd)^2$$

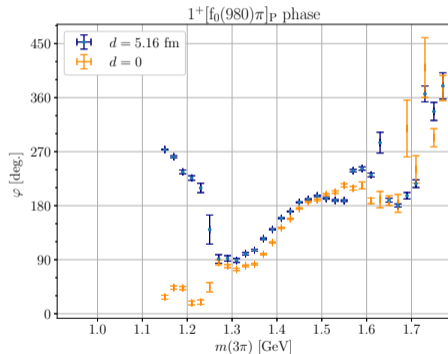

F takes into the finite size of a meson

Each partial wave is multiplied by two F 's corresponding to either X^- or ξ^0

F_S for ξ^0 depends on the break-up momentum in the rest frame of ξ^0

F_L for X^- depends on the break-up momentum in the rest frame of X^-

There are two alternative parametrizations for F , I use the relativistic one, for example for a P wave

$$F_P(x) = \sqrt{\frac{1-x_0}{1-x}}, \quad x = (pd)^2$$

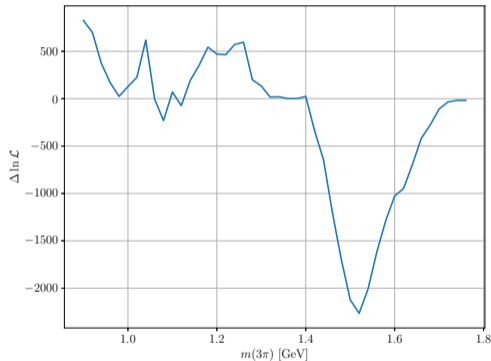

Difference between $\ln \mathcal{L}$ of the fit.

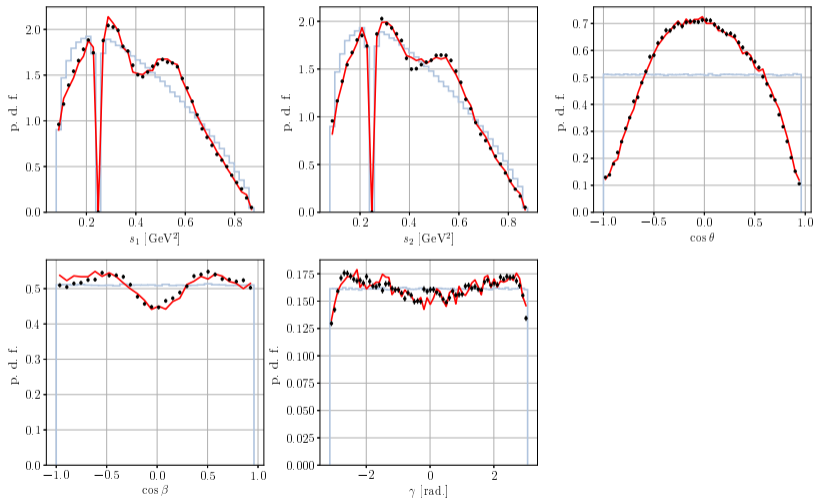

$$\mathcal{I}_{wv}(\Phi) \rightarrow \int \mathcal{I}_{wv}(\Phi') \varepsilon(\Phi, \Phi') d\Phi',$$

Φ — reconstructed phase space variables, Φ' — generated phase space variables

Requires MC sampling for each event

Unknown $\varepsilon(\Phi, \Phi')$

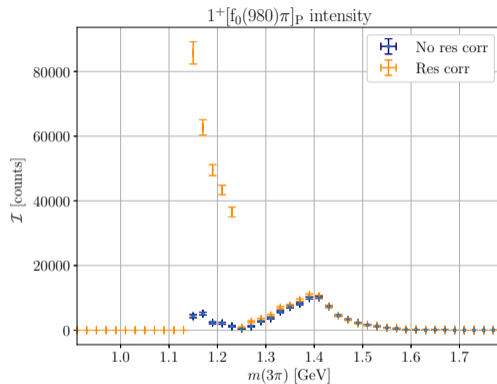

Intensity of the $1^+[f_0(980)\pi]_P$ wave.

$$\mathcal{I}_{wv}(\Phi) \rightarrow \int \mathcal{I}_{wv}(\Phi') \varepsilon(\Phi, \Phi') d\Phi',$$

Φ — reconstructed phase space variables, Φ' — generated phase space variables

Requires MC sampling for each event

Unknown $\varepsilon(\Phi, \Phi')$

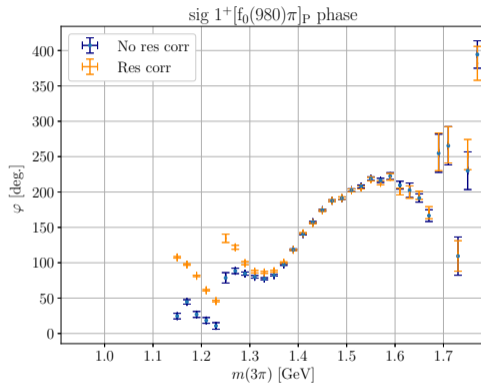

Phase of the $1^+[f_0(980)\pi]_P$ wave.

Four major sources:

- Model:
 - ▶ Isobar parametrization
 - ▶ Model selection
- Background
 - ▶ Model in simulations
 - ▶ Neural network parametrization
- Acceptance
 - ▶ Stat. uncertainty of \mathcal{N}_{wv}
 - ▶ Momentum correction
- Detector resolution

Neural network* trained on simulated data

Neural network shape fixed in PWA

Test background leakage on simulated data

Background still leaks to signal

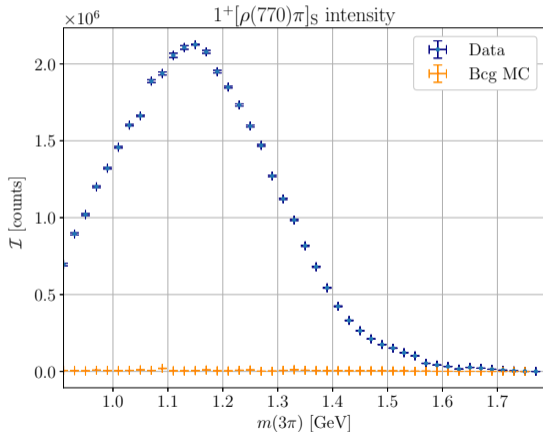

- Neural network* trained on simulated data
- Neural network shape fixed in PWA
- Test background leakage on simulated data
- Background still leaks to signal

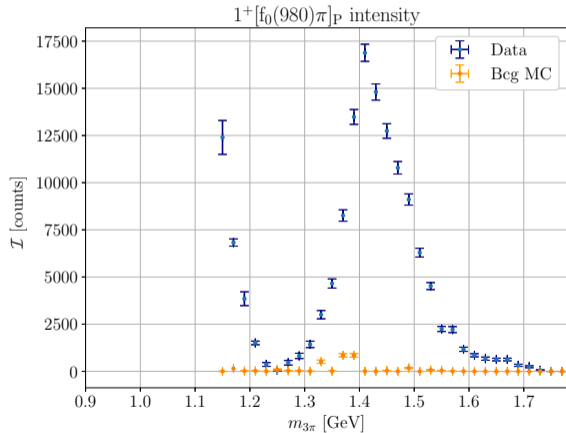

Neural network uncertainty:

Plots' legend:

- Stat. uncertainty
- Syst. uncertainty

Propagate uncertainties by varying neural network parameters before PWA

25–120 networks/bin

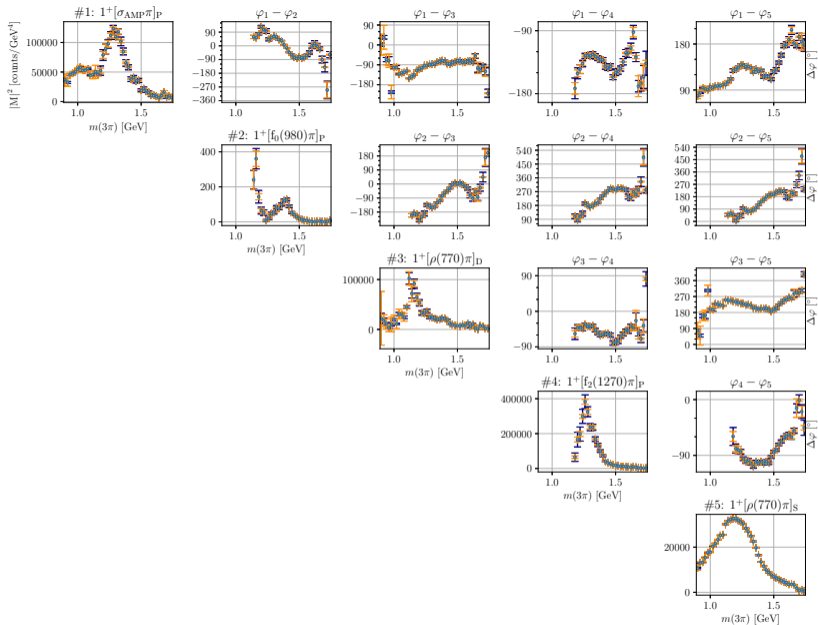

Integrals uncertainty:

Plots' legend:

- Stat. uncertainty
- Syst. uncertainty

Propagate statistical uncertainties of integrals by varying integrals within their statistical uncertainties before PWA

Correlations not taken into account

$100 \mathcal{N}_{wv}/\text{bin}$

