

# Trigger Efficiency Measurement at Belle II for $ee \rightarrow \tau\tau$



Petar Rados (DESY)  
on behalf of the Belle II collaboration



**ICHEP 2020 | PRAGUE**

40<sup>th</sup> INTERNATIONAL CONFERENCE  
ON HIGH ENERGY PHYSICS

**VIRTUAL  
CONFERENCE**

**28 JULY - 6 AUGUST 2020**

PRAGUE, CZECH REPUBLIC



# SuperKEKB Accelerator

- New facility to search for new physics by studying  $B$ ,  $D$  and  $\tau$  decays
- Electron-positron collisions at  $\sqrt{s} \approx 10.6$  GeV

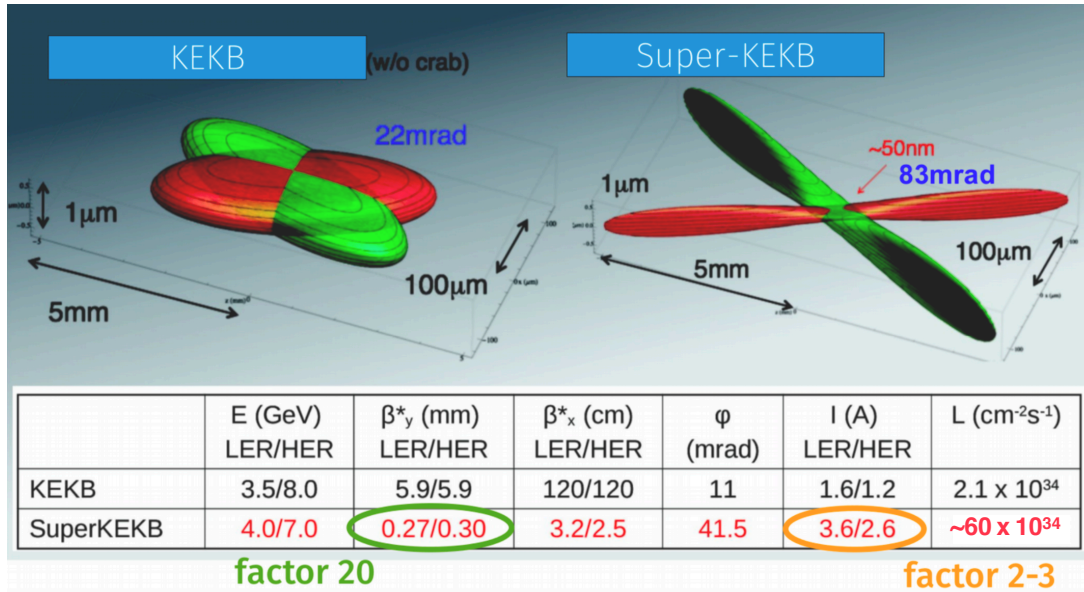

- Unprecedented design luminosity of  $\sim 6 \times 10^{35} \text{ cm}^{-2}\text{s}^{-1}$ . Broke the world record last month!
- First beams/commissioning in 2016, Belle II rolled in 2017, first collisions in April 2018

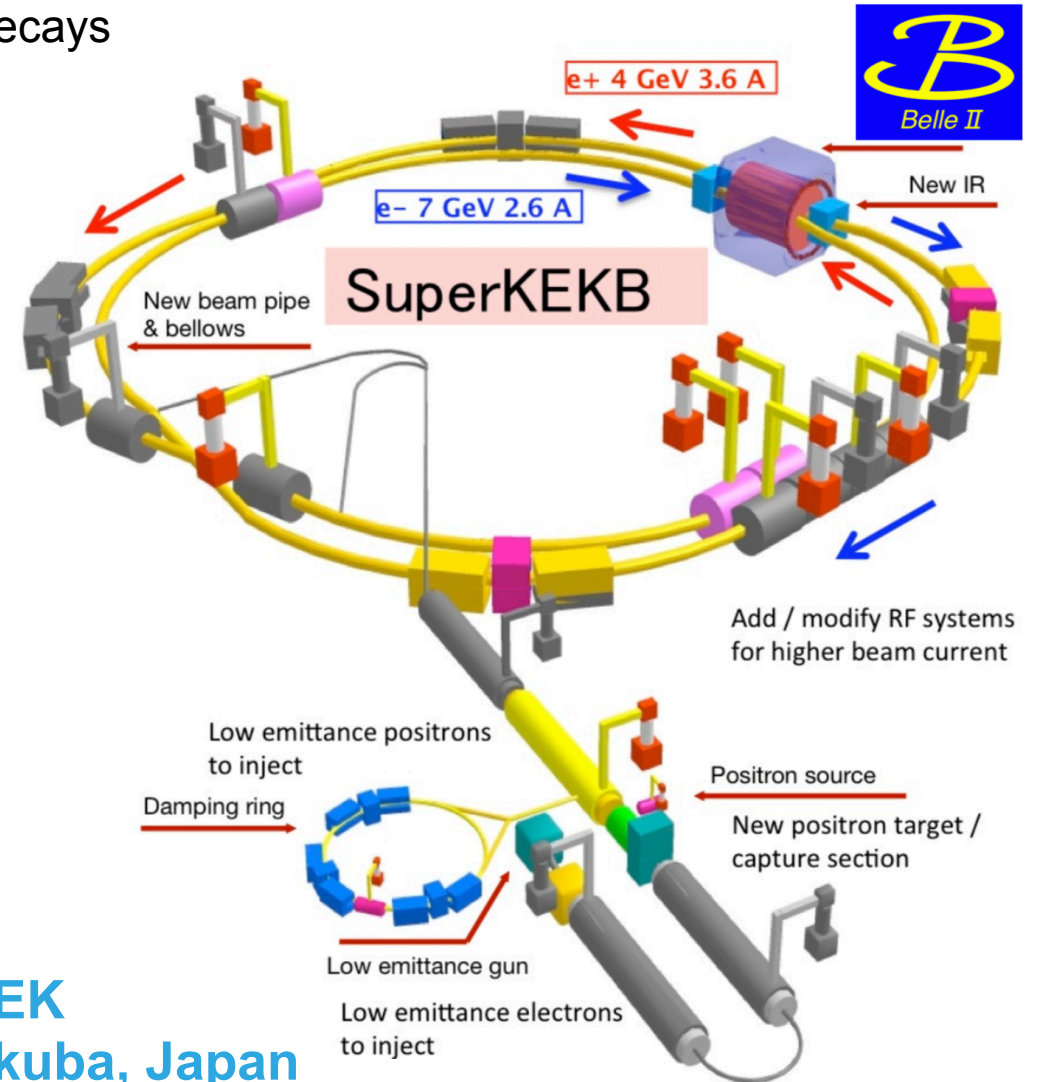

@KEK  
Tsukuba, Japan

# Belle II Detector

- Phase 3 of data taking began in March 2019  $\Rightarrow$   $\sim 74 \text{ fb}^{-1}$  collected so far
- Results shown today are with the 2019 dataset  $\Rightarrow 8.8 \text{ fb}^{-1}$

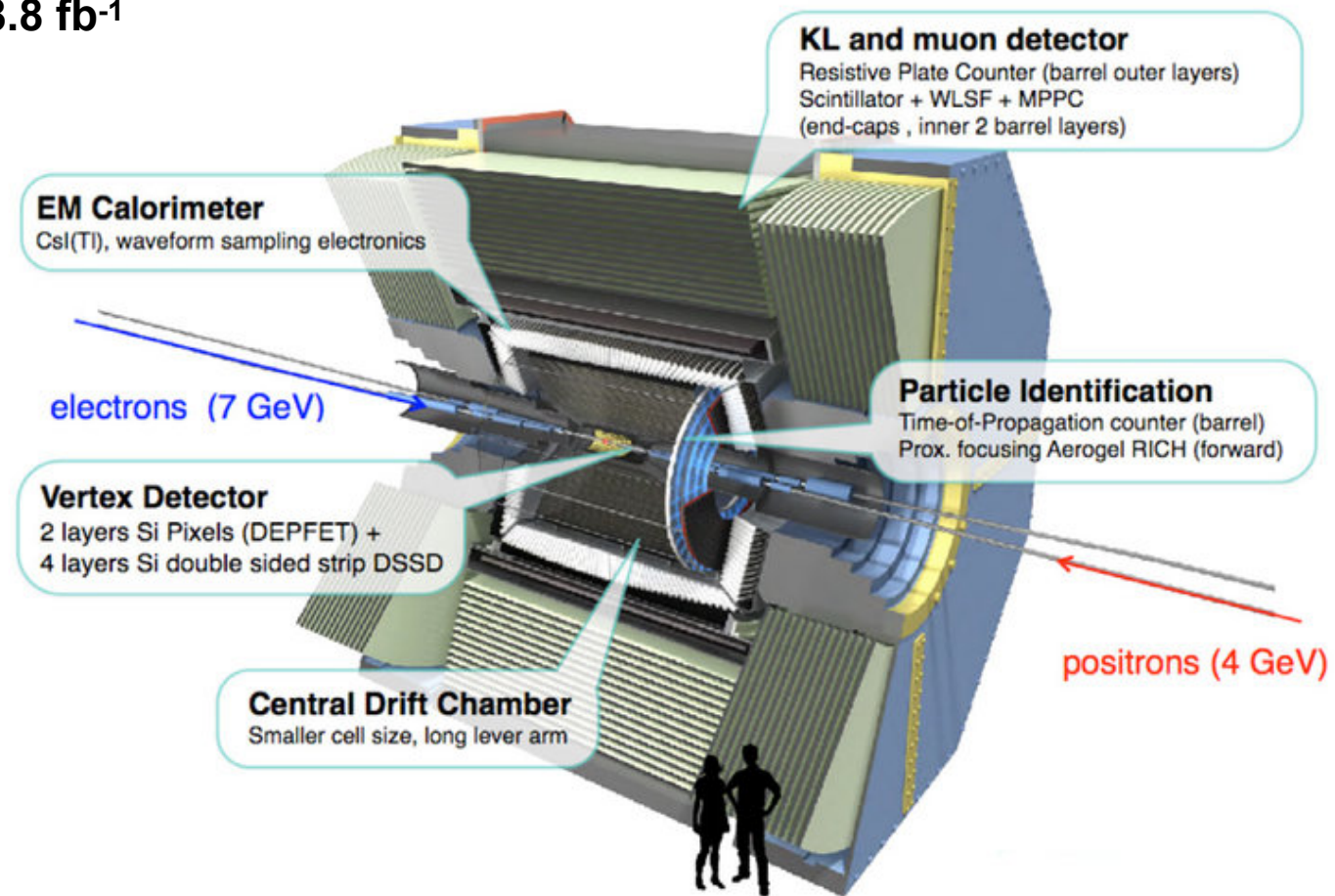
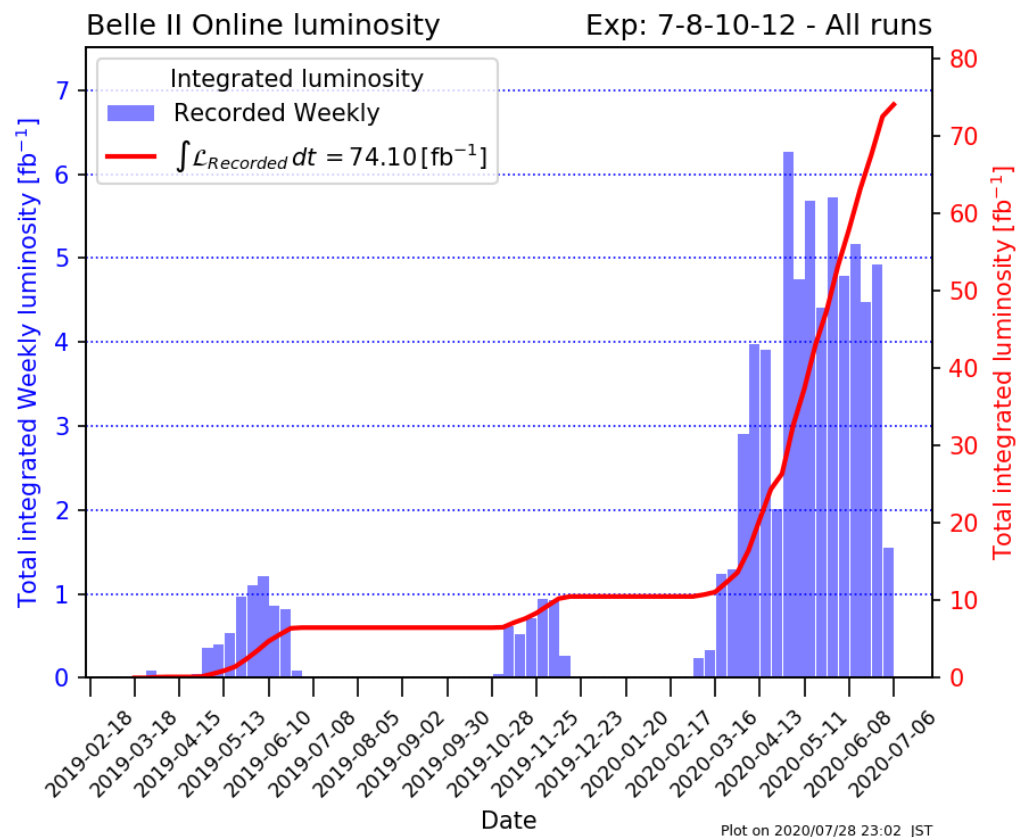

- Aiming for  $50 \text{ ab}^{-1}$  over the next  $\sim 10$  years (50 times Belle dataset)

# L1 Trigger System

- Total physics event rate at SuperKEKB design luminosity is **~20 kHz**, **~3%** of which comes from  $ee \rightarrow \tau\tau$

- Sizeable beam background
  - Touschek and beam-gas scattering
  - synchrotron radiation
  - radiative Bhabha, injection + more

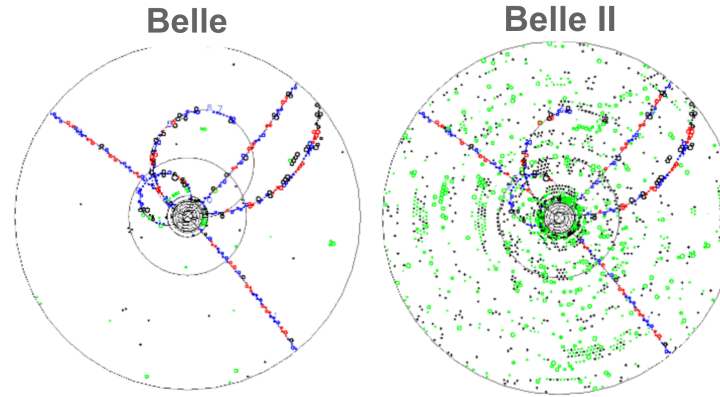

Physics process	Cross section (nb)	Rate (Hz)
$\Upsilon(4S) \rightarrow B\bar{B}$	1.2	960
$e^+e^- \rightarrow \text{continuum}$	2.8	2200
$\mu^+\mu^-$	0.8	640
$\tau^+\tau^-$	0.8	640
Bhabha ( $\theta_{\text{lab}} \geq 17^\circ$ )	44	350 <sup>a</sup>
$\gamma\gamma$ ( $\theta_{\text{lab}} \geq 17^\circ$ )	2.4	19 <sup>a</sup>
$2\gamma$ processes <sup>b</sup>	$\sim 80$	$\sim 15000$
<b>Total</b>	$\sim 130$	<b><math>\sim 20000</math></b>

- L1 trigger must reduce physics + bkg rate to a maximum of **30 kHz**

- Requirements
  - high efficiency for physics processes
  - trigger latency  $\sim 5\mu\text{s}$ , timing precision  $\leq 10\text{ ns}$
  - two event separation  $\geq 200\text{ ns}$
- Two primary components: **CDC** and **ECL** triggers
  - CDC 2D ( $r-\phi$  space) track finding
  - ECL total energy and cluster finding, Bhabha veto

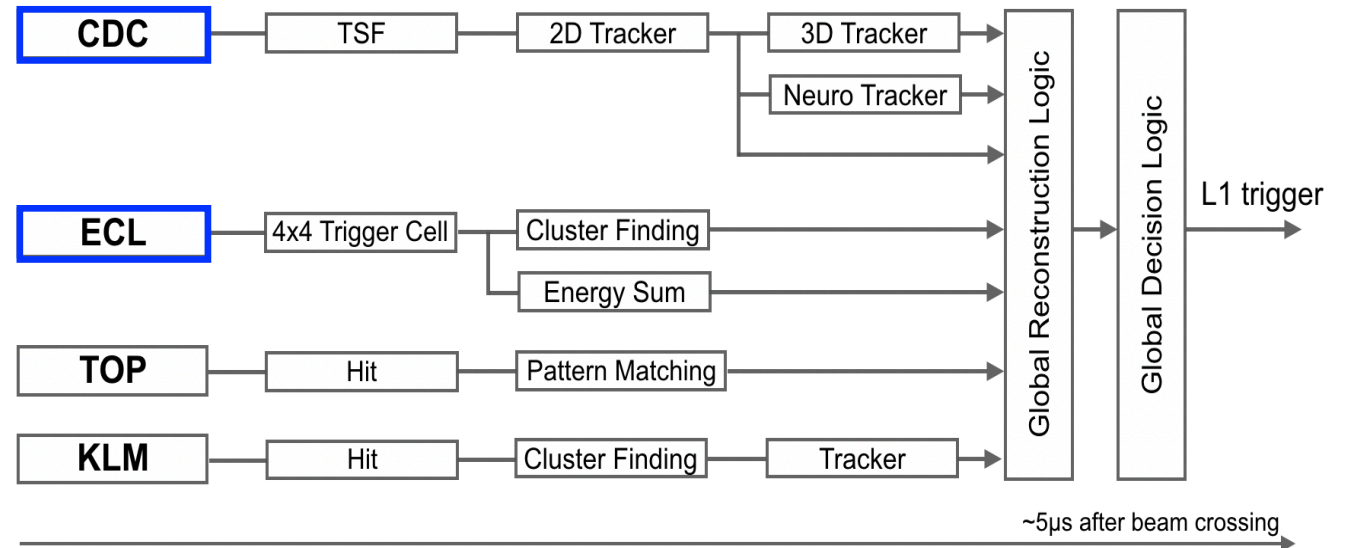

# Tau reconstruction

- $ee \rightarrow \tau\tau$  events are an ideal testbed of L1 performance for low multiplicity physics
  - large cross section:  $\sigma(\tau\tau) \approx \sigma(BB)$ , at  $\sqrt{s}=m_{Y(4s)}$
  - wide variety of signatures involving tracks ( $e, \mu, \pi$ ) and clusters ( $e, \mu, \pi, \pi^0$ )

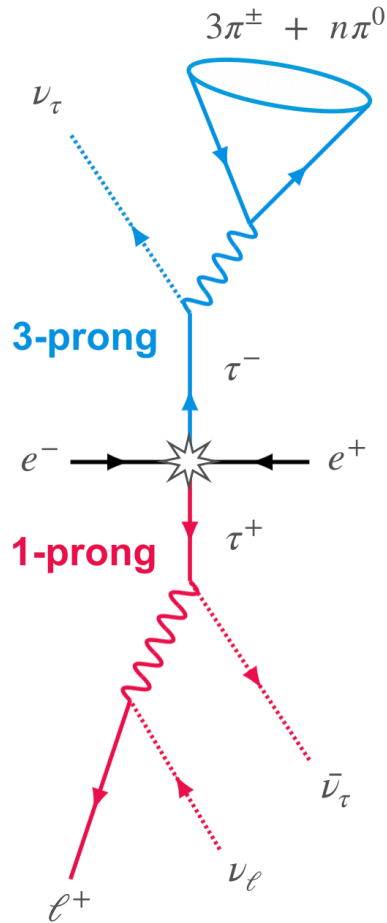

- Reconstruct **1-prong**, **3-prong**  $\tau$  decays in 6 channels:
  - **e-3 $\pi$** ,  **$\mu$ -3 $\pi$** ,  **$\pi$ -3 $\pi$** , **e $\mu$** ,  **$\mu\pi$** ,  **$\mu\mu$**
- E/p + likelihood based electron, muon and pion ID
- Tracks required to be 1x3 or 1x1 wrt thrust axis

## 1x3 selection

- thrust value > 0.9
- $E_{\text{vis}}^{\text{cms}} < 9.7$  GeV
- $\pi^0$  multiplicity:
  - leptonic decay: 0
  - hadronic decay:  $\leq 2$
- $\leq 1$  additional good  $\gamma$  in each hemisphere

## 1x1 selection

- $0.89 < \text{thrust} < 0.99$
- $2.35 < E_{\text{vis}}^{\text{cms}} < 9.5$  GeV
- $0.59 < \theta_{\text{pmiss}} < 2.8$
- $\pi^0$  multiplicity:
  - leptonic decay: 0
  - hadronic decay:  $\leq 2$
- $\leq 1$  additional good  $\gamma$  in each hemisphere

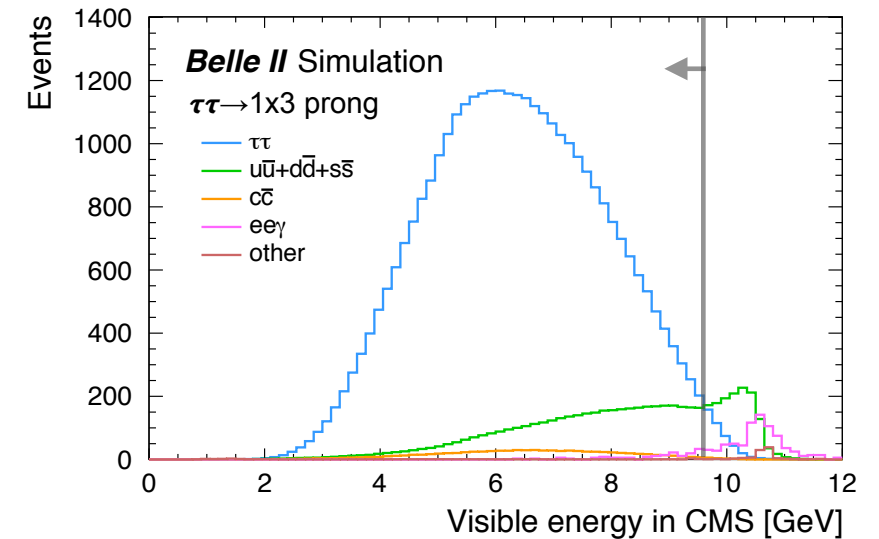
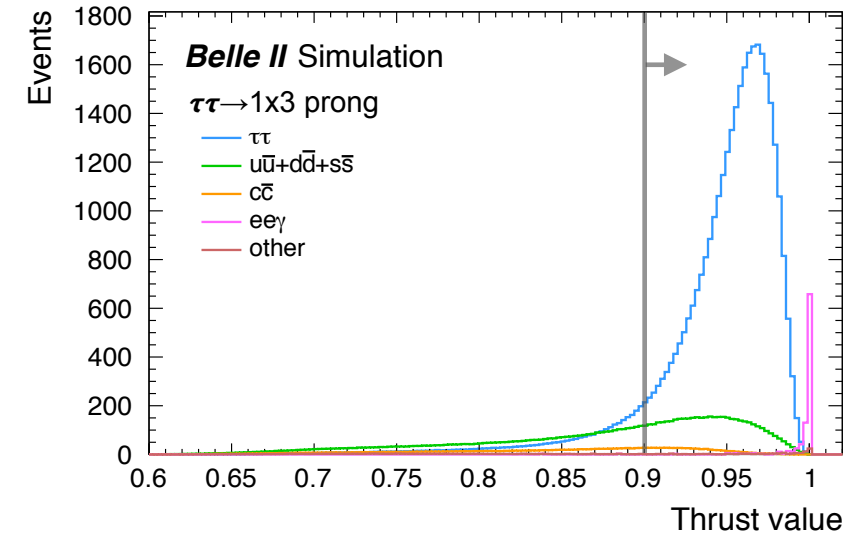

# Efficiency for 1x3 prong

BELLE2-NOTE-PL-2020-015

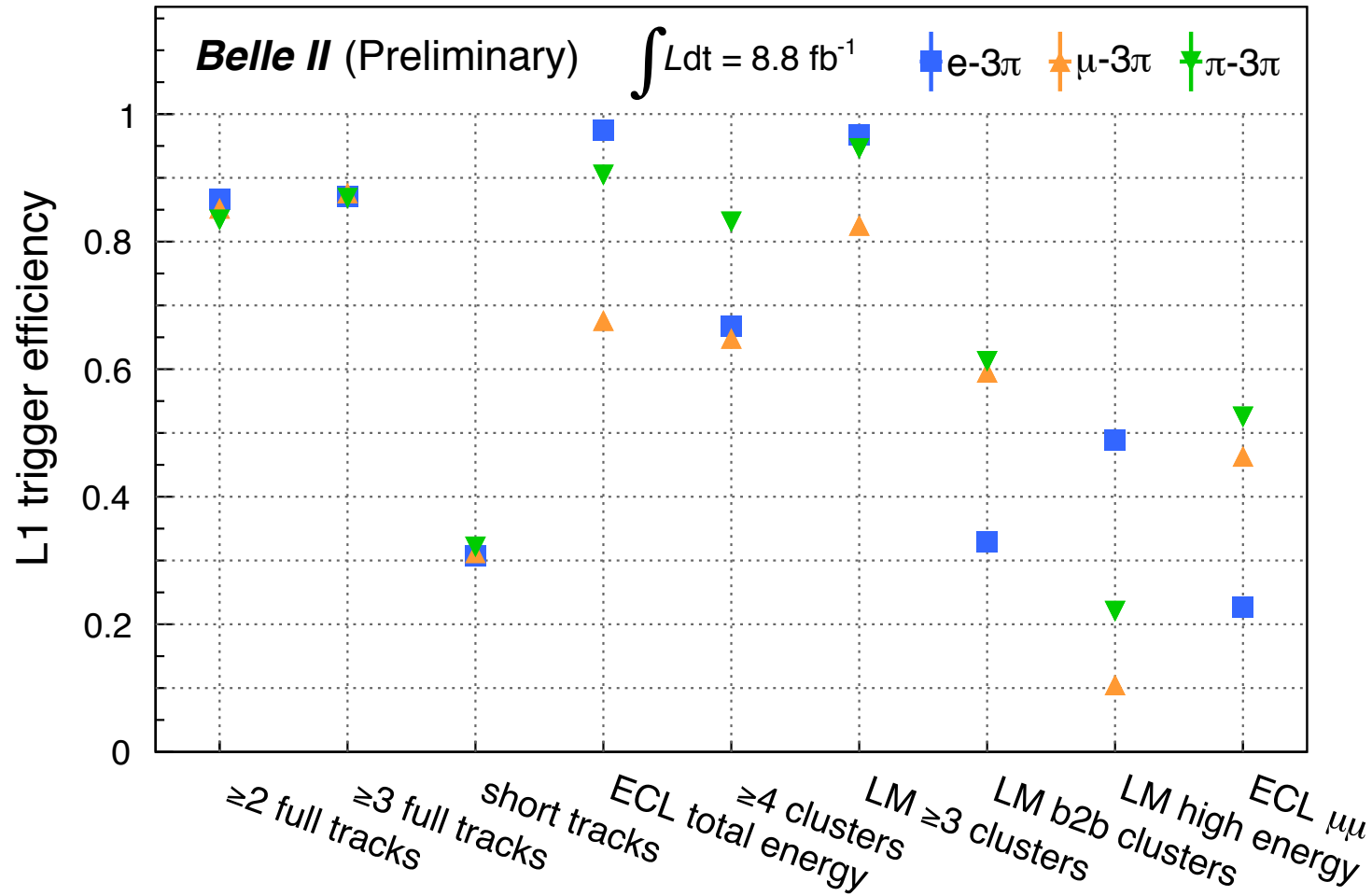

- Main trigger types for tau and other low-multiplicity physics

- CDC number of 2D full tracks
- CDC number of 2D short tracks
- ECL total energy threshold
- ECL number of isolated clusters
- ECL low multiplicity
- ECL di-muon

- Trigger decision is made independently using only CDC or ECL information. Allows measurement of L1 efficiency in data.

- Efficiency of a CDC/ECL trigger:

$$\frac{(\text{OR of ECL/CDC bits}) \text{ AND CDC/ECL bit}}{(\text{OR of ECL/CDC bits})}$$

# Efficiency for 1x1 prong

BELLE2-NOTE-PL-2020-015

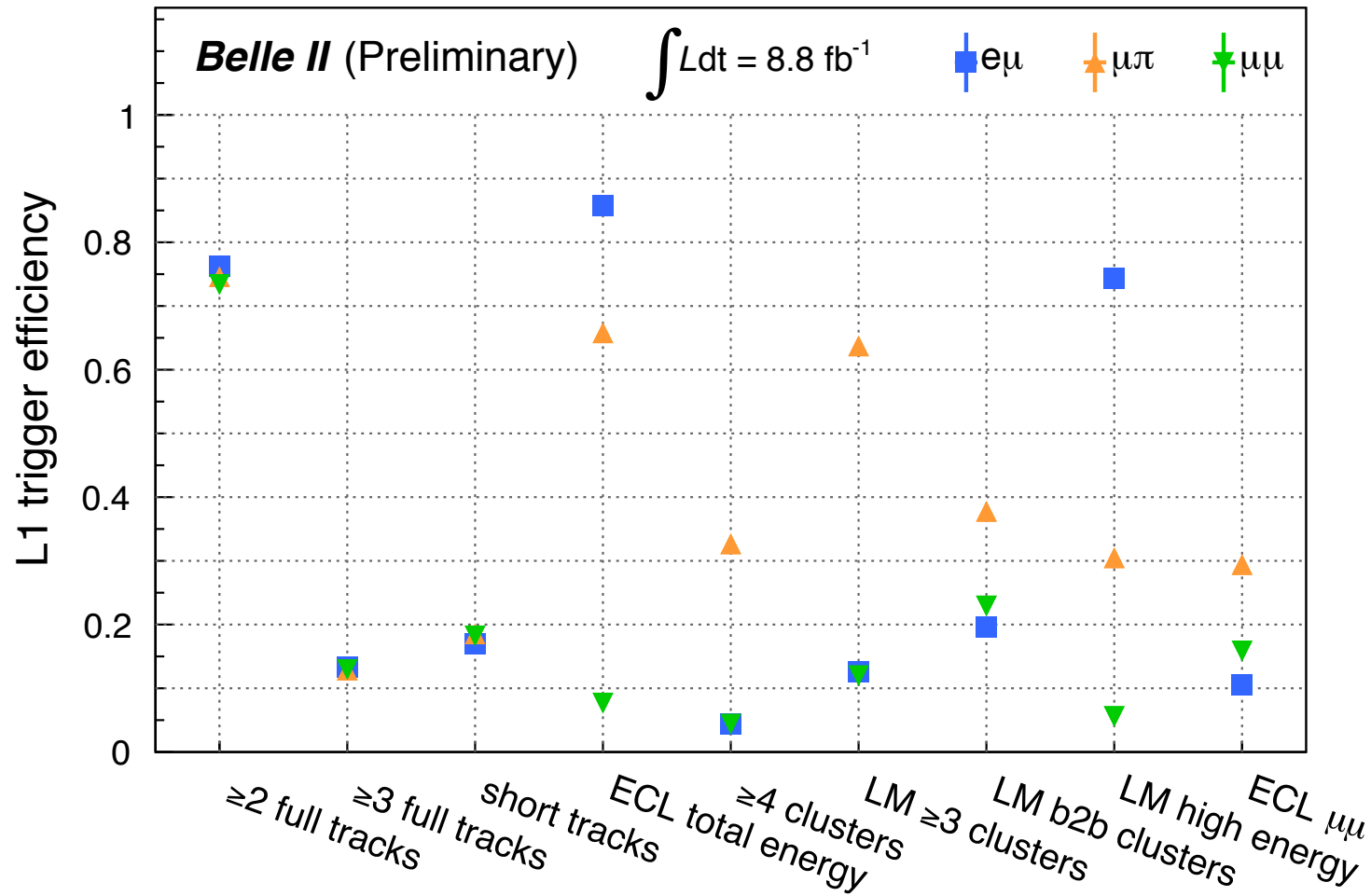

- Main trigger types for tau and other low-multiplicity physics

- CDC number of 2D full tracks
- CDC number of 2D short tracks
- ECL total energy threshold
- ECL number of isolated clusters
- ECL low multiplicity
- ECL di-muon

- Trigger decision is made independently using only CDC or ECL information. Allows measurement of L1 efficiency in data.

- Efficiency of a CDC/ECL trigger:

$$\frac{(\text{OR of ECL/CDC bits}) \text{ AND CDC/ECL bit}}{(\text{OR of ECL/CDC bits})}$$

# Full and short track triggers

- “full tracks” pass through all axial CDC superlayers and reach the barrel

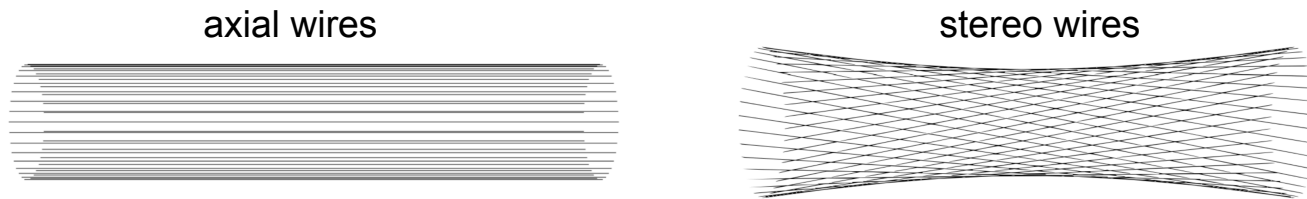

- Full track triggers have low efficiency in endcaps, putting limitations on tau and other low multi physics
- To help compensate, the CDC trigger also searches for “short tracks” that pass through inner most 5 axial + stereo SLs. Operational since Oct 2019.

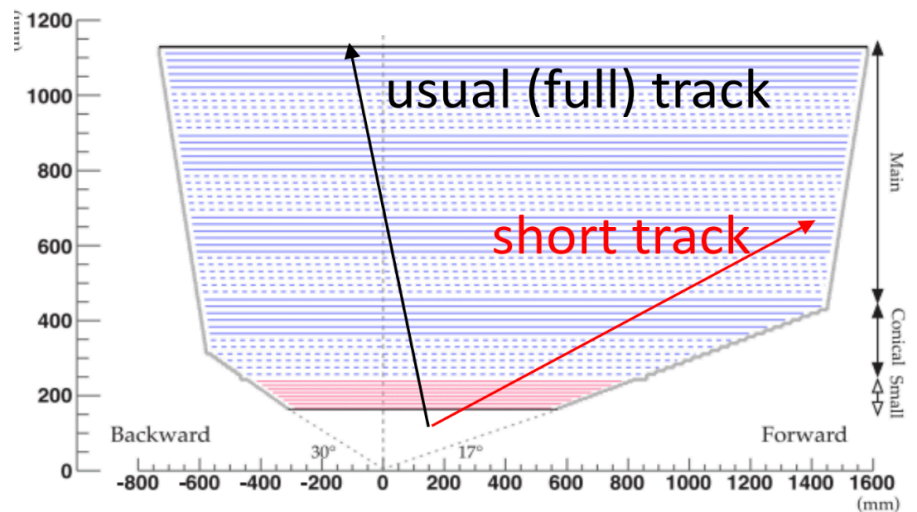

- Short track triggers provide a significant gain in efficiency for endcaps / low  $p_T$ !

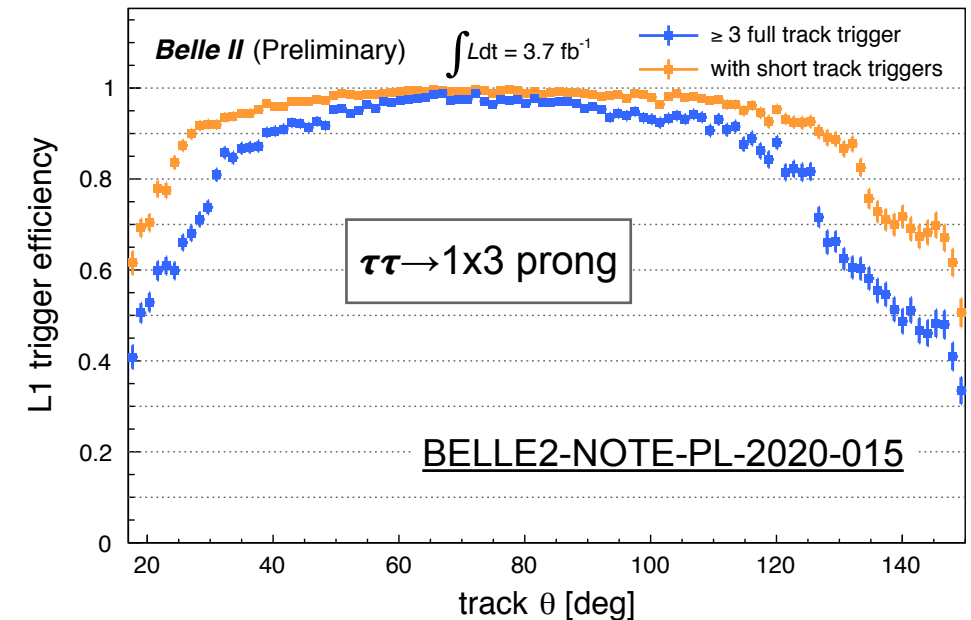
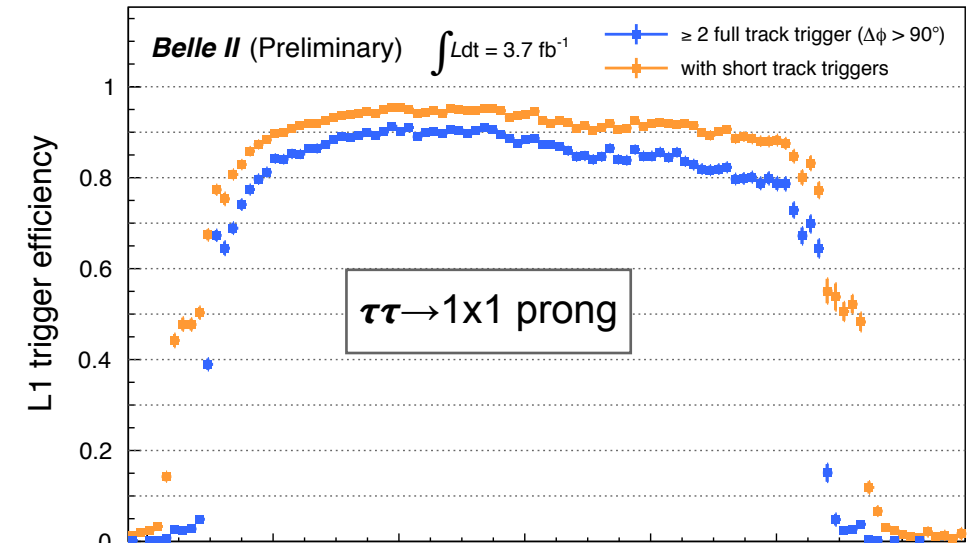



# Full and short track triggers

$ee \rightarrow \tau\tau \rightarrow 1x1$  prong

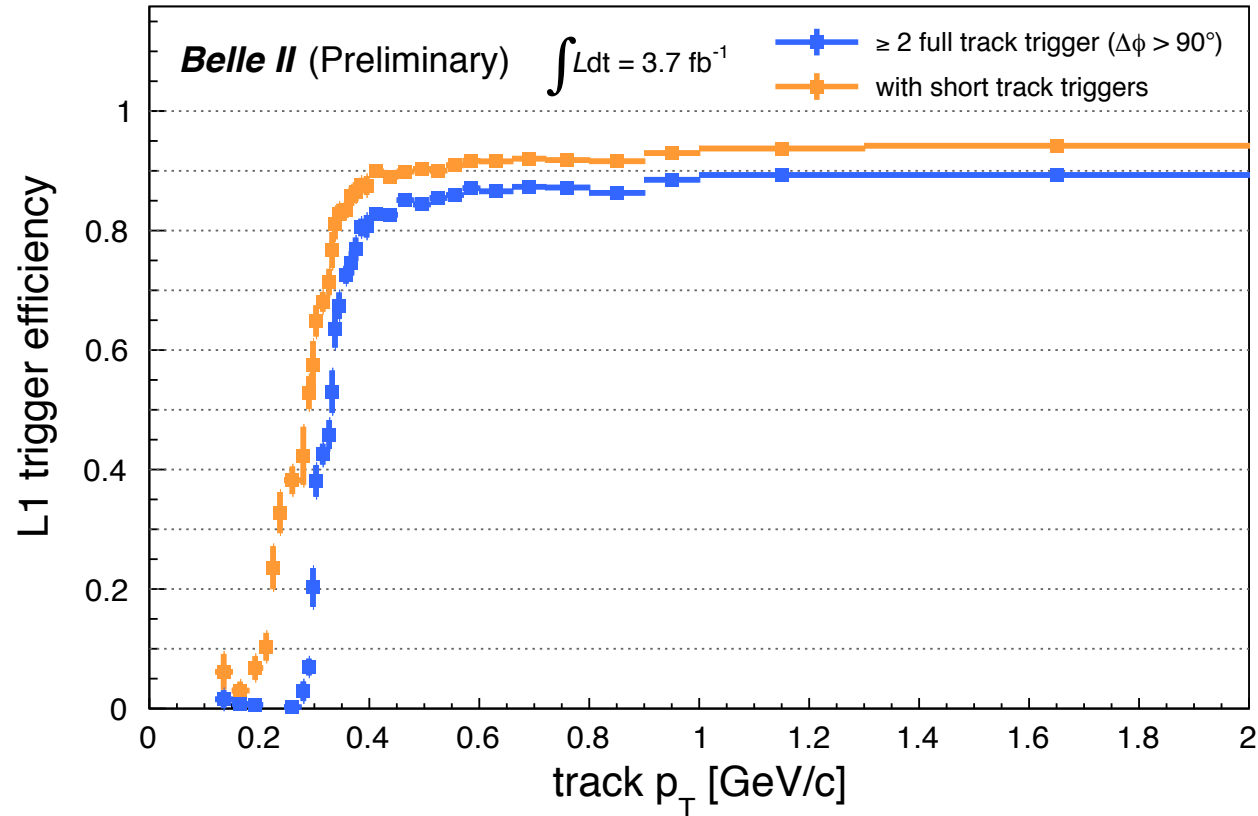

$ee \rightarrow \tau\tau \rightarrow 1x3$  prong

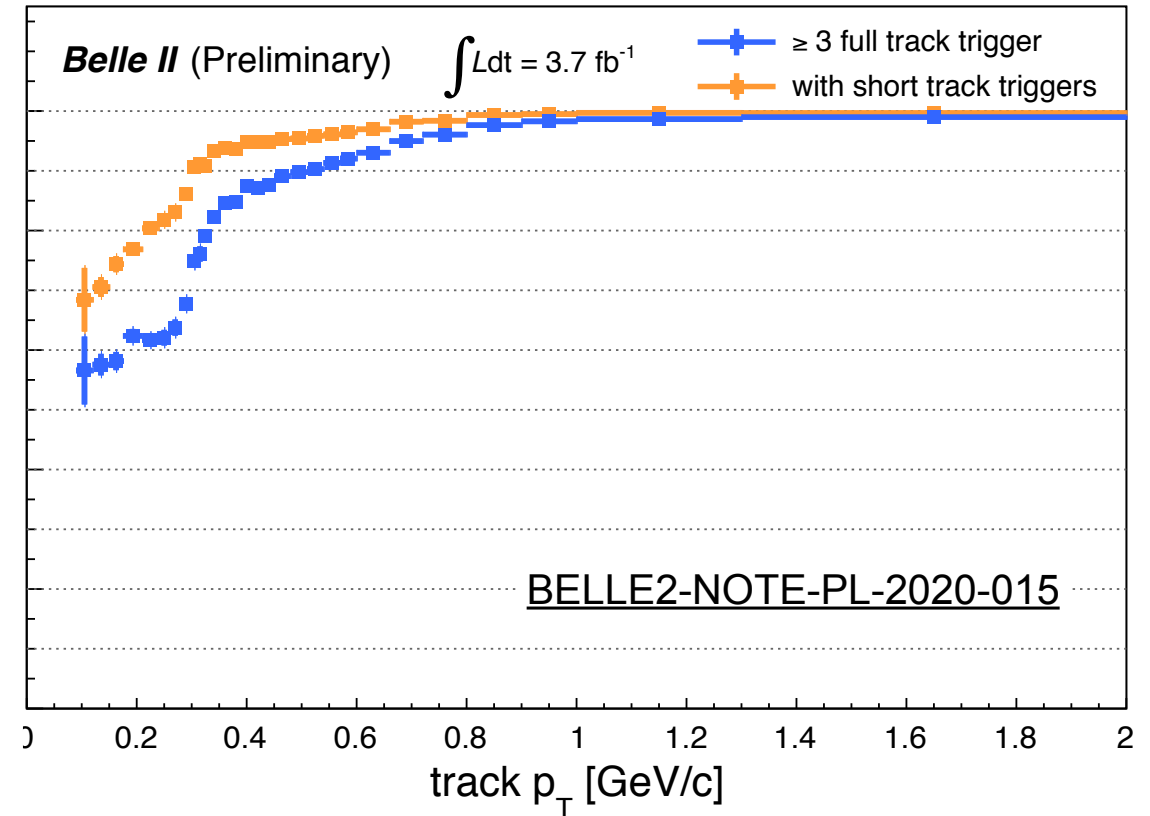

# Energy threshold trigger

- ECL trigger provides energy deposit and cluster information, as well as the identification of Bhabha events
- Unprescaled total energy trigger has 1 GeV threshold.  
Sum over L1 Trigger Cells  $\Rightarrow$  4x4 tower of CsI(Tl) crystals.
- Performs well for  $ee \rightarrow \tau\tau$  events that have high EM energy deposition (e.g.  $\tau \rightarrow e\nu\nu$ ,  $3\pi\pi^0\nu$ ,  $\pi\pi^0\nu$ )

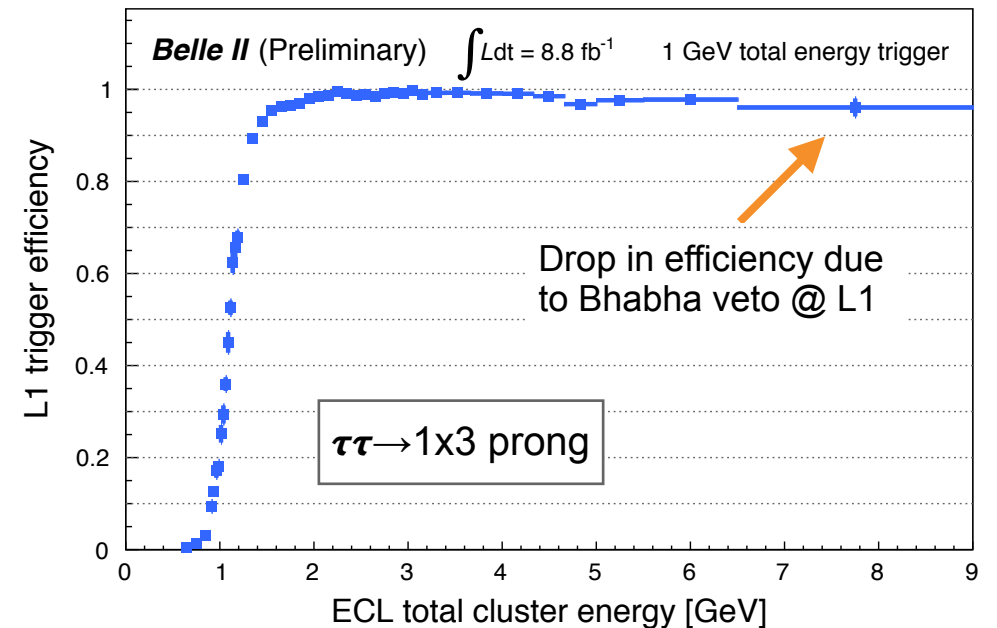
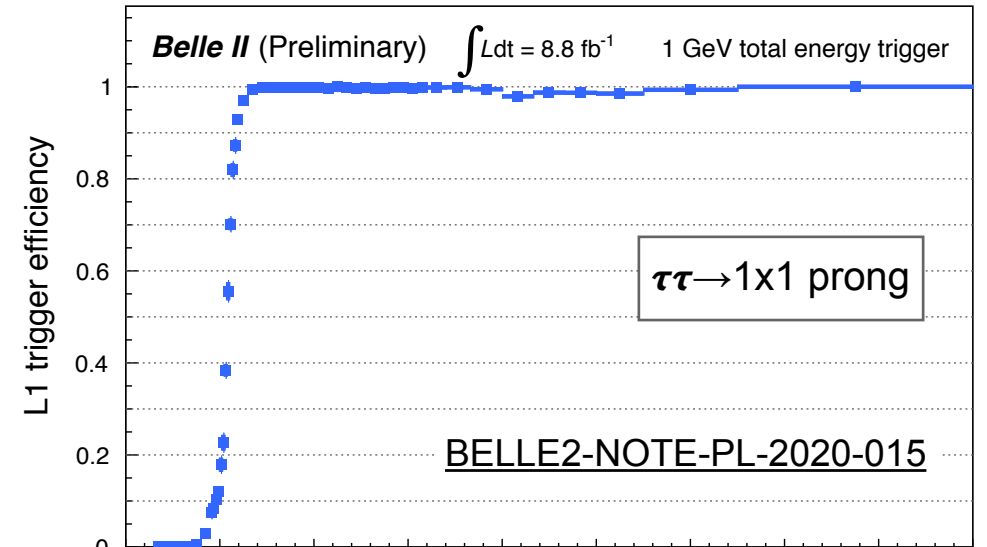
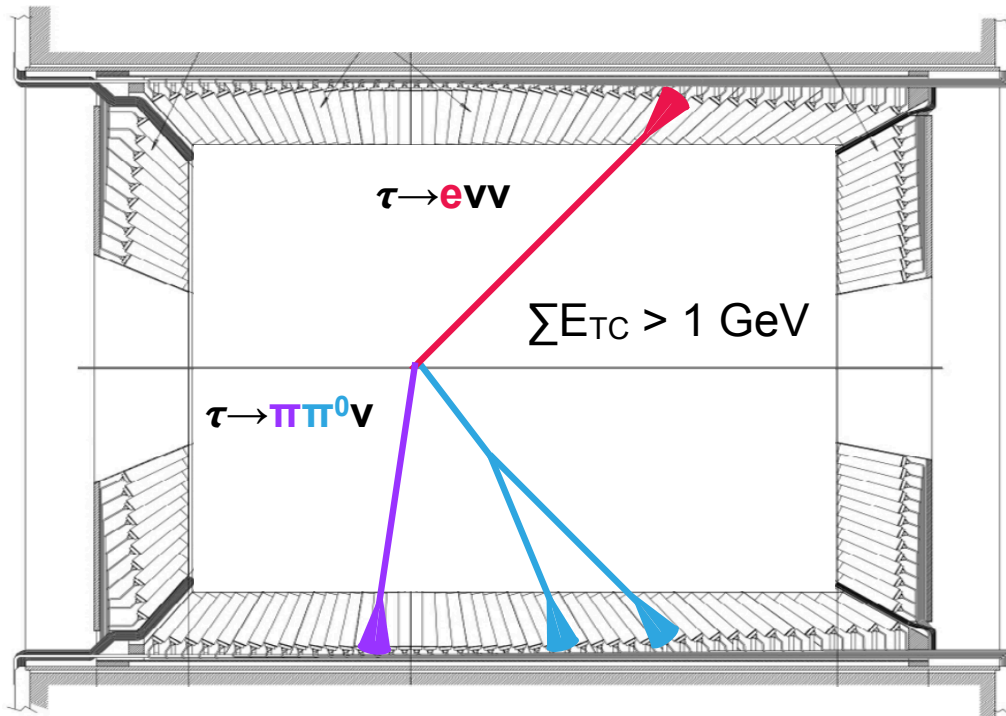

# Searches for charged LFV

- LFV has been established for the neutrinos, but what about their charged partners (e,  $\mu$  and  $\tau$ )?
- In the SM, charged LFV decays via neutrino oscillation are highly suppressed and immeasurably small:

$$Br(\ell_1 \rightarrow \ell_2 \gamma)_{SM} \propto \left( \frac{\delta m_\nu^2}{m_W^2} \right)^2 \sim 10^{-54} - 10^{-49}$$

- **Observation of charged LFV would be a clear signature for New Physics!**

- $Br$  enhanced in many new physics models ( $10^{-10}$ - $10^{-7}$ )
- $\mu \rightarrow e$ : stringent bounds exist from MEG
- $\tau \rightarrow \mu/e$ : weaker bounds (Belle, BaBar and CLEO)

- As heaviest lepton, NP can have preferential  $\tau$  LFV couplings
- **Belle II will push the current  $\tau$  LFV bounds forward by at least one order of magnitude!**

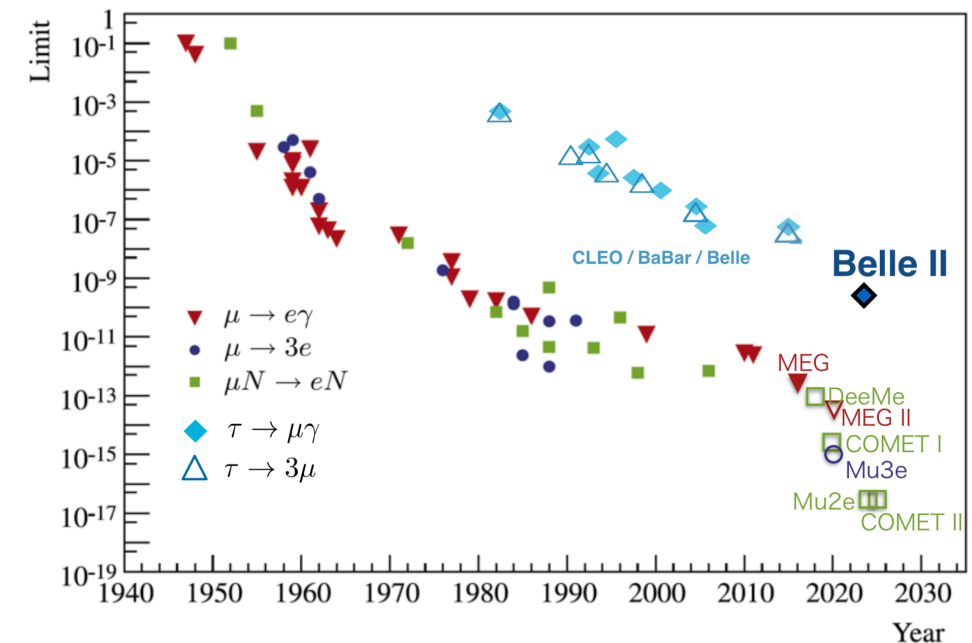
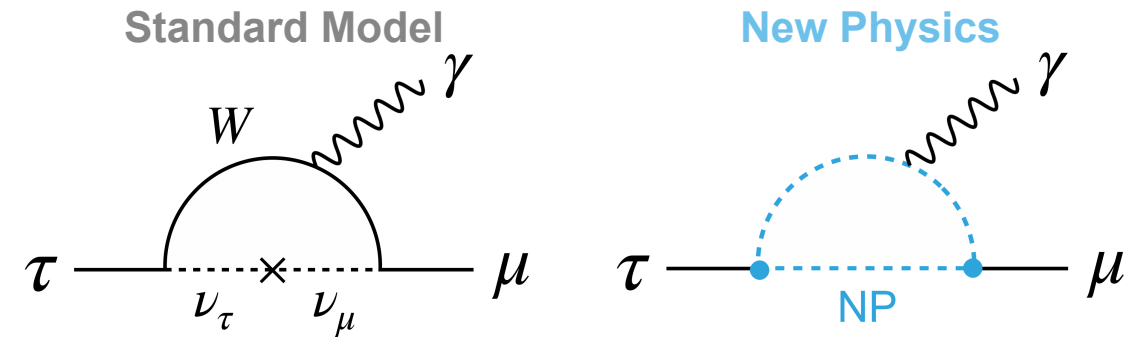

# Trigger efficiency for $\tau$ LFV

- One of the golden channels for LFV discovery in the tau sector is  $\tau \rightarrow 3\mu$   
Most challenging  $\tau$  LFV signatures to trigger on @ L1.

(see *K. Inami's talk* on Friday)

## Strategy:

study trigger efficiency using SM  $\tau$  decay mode that best mimics LFV signal  
 $\Rightarrow$  SM  $\tau \rightarrow 1 \times 3$  prong (3 $\pi$  instead of 3 $\mu$ )

- Selections follow those of the SM decay study, but with cuts that make the SM process mimic the signal
  - $p_{\text{miss}} > 0.2$  GeV, thrust  $< 0.97$
  - $M_{\text{tag}} < 1.15$  GeV,  $\Delta E_{\text{tag}} < -0.7$  GeV
- ECL low multiplicity triggers are new at Belle II.  
Most performant for LFV-like events around  $\Delta E_{\text{signal}} \sim 0$   
is the  $\geq 3$  ECL cluster trigger

BELLE2-NOTE-PL-2020-015

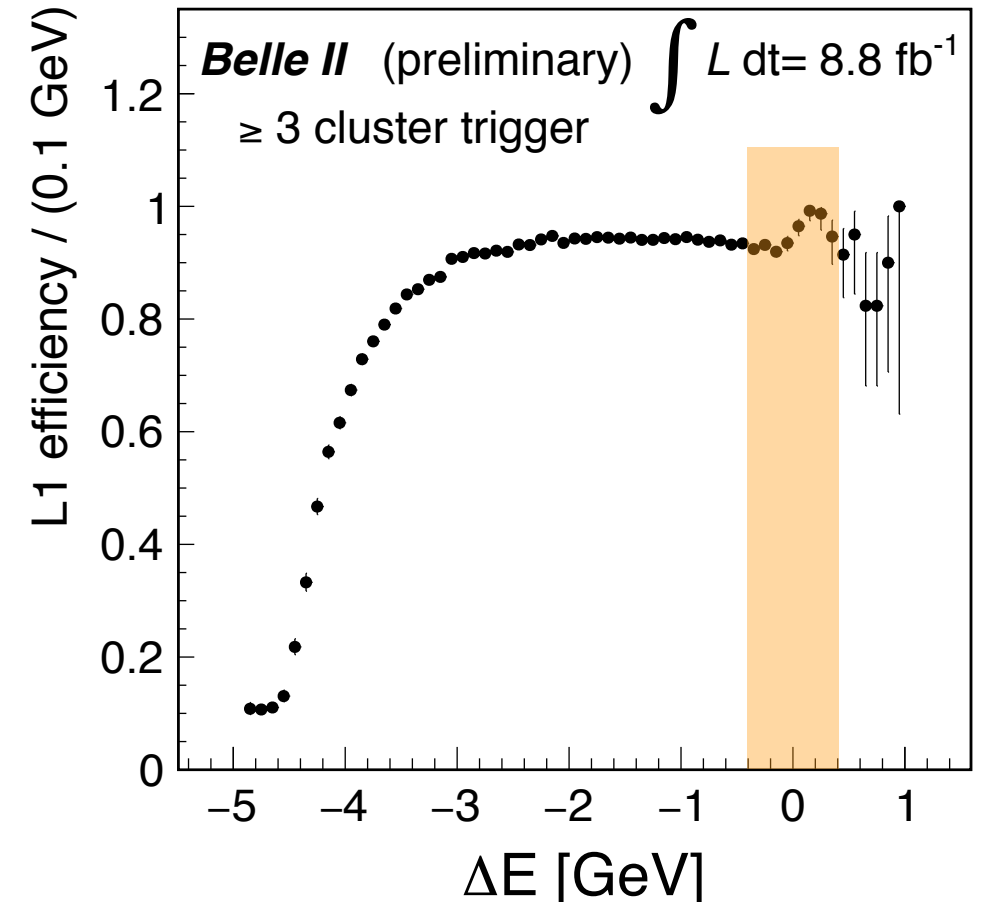

# Trigger efficiency for $\tau$ LFV

$\mu$ - $3\pi$ , LFV-like event

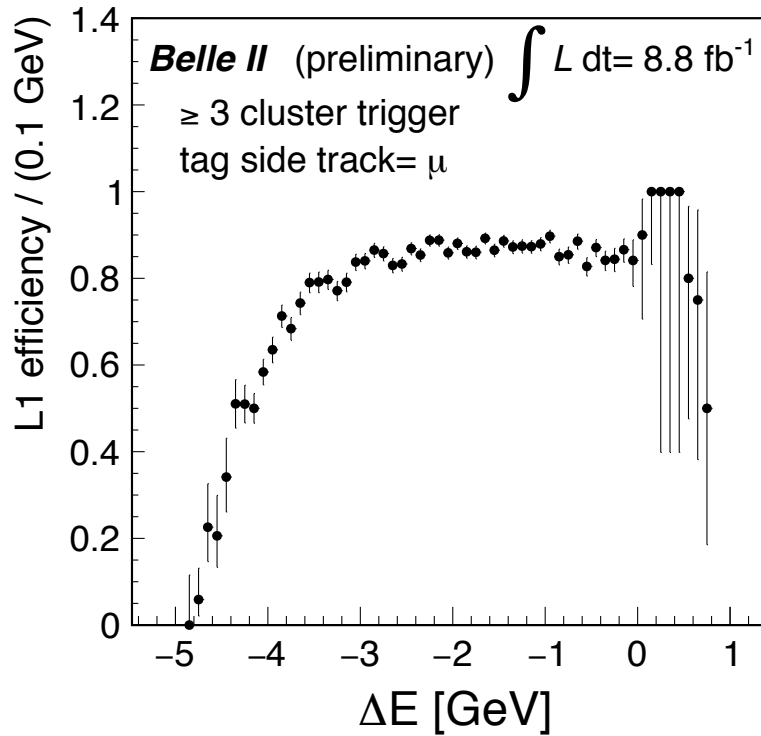

$e$ - $3\pi$ , LFV-like event

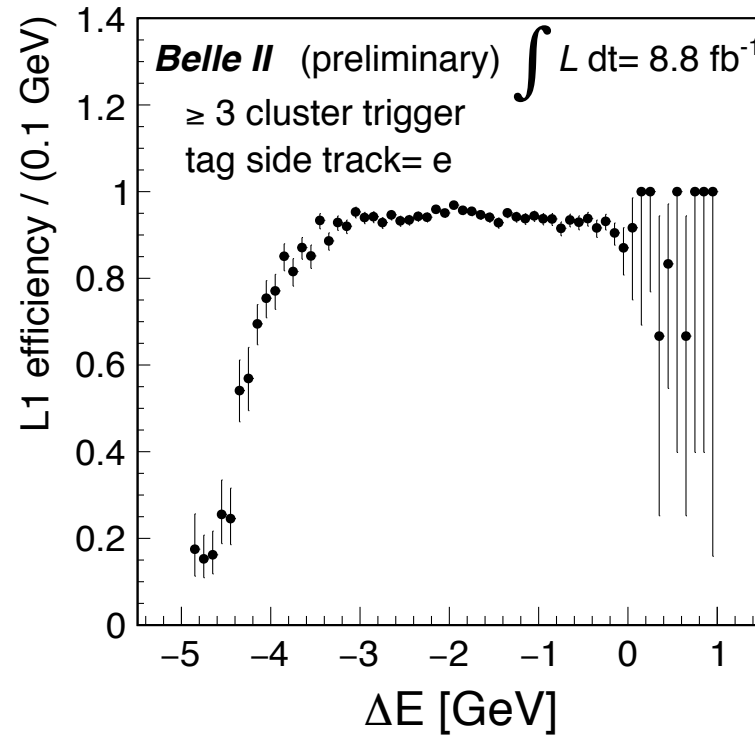

$\pi$ - $3\pi$ , LFV-like event

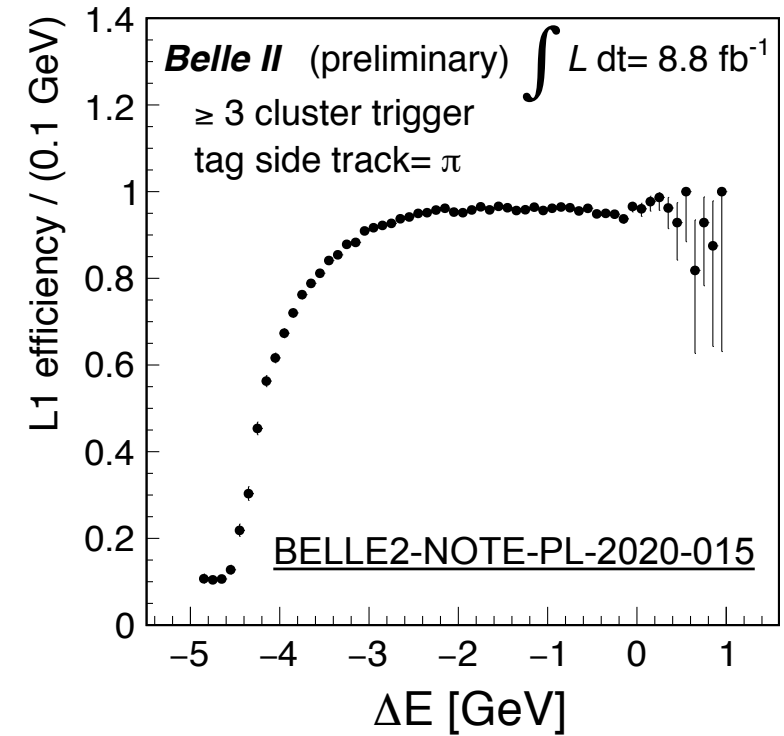

# Conclusion

- L1 trigger system plays a critical role in enabling tau and other low-multiplicity physics at Belle II.
- L1 efficiency has been measured for  $ee \rightarrow \tau\tau \rightarrow 1x3, 1x1$  prong events. [BELLE2-NOTE-PL-2020-015](#)  
Overall good performance in the early Phase 3 data.
- Drop in CDC full track trigger efficiency when at least one of the tracks are in the endcaps. Largest impact on 1x1 prong events. New short track triggers show great promise.
- New ECL low multiplicity triggers will play an important role in future  $\tau$  LFV results.
- Upcoming L1 developments:
  - reduction of background with 3D tracking and noise reduction
  - neural-z triggers: compute and cut on  $z_0$  within L1 latency, significantly reducing bkg rate

**BACKUP**

# Full track triggers

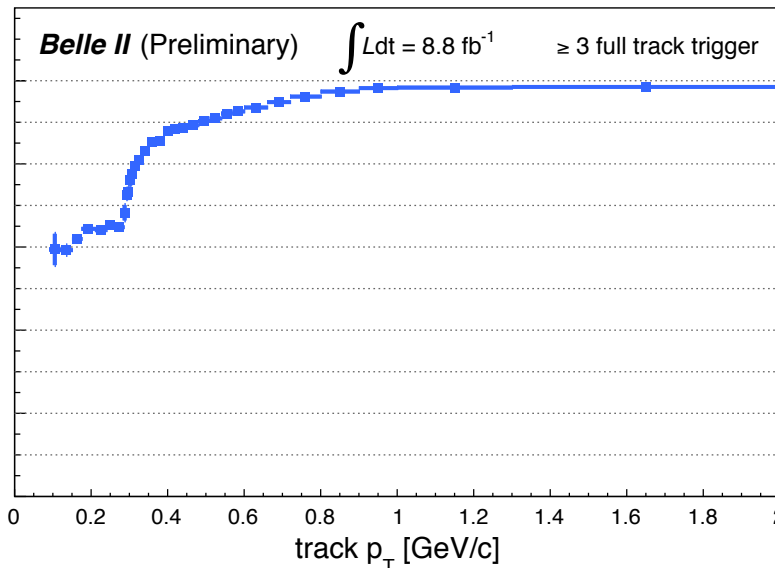
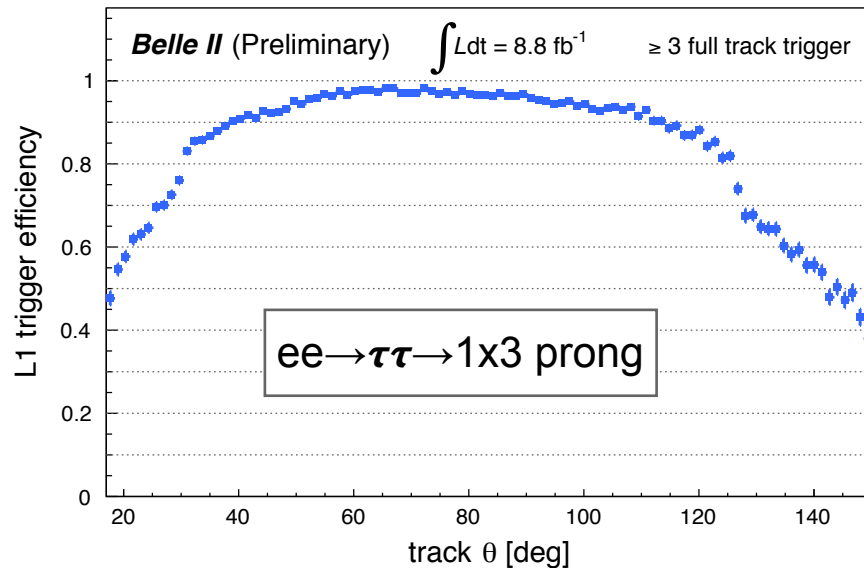
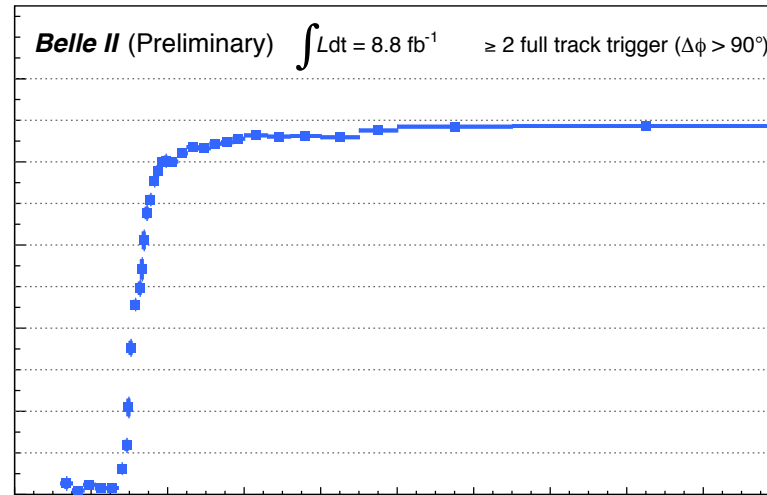
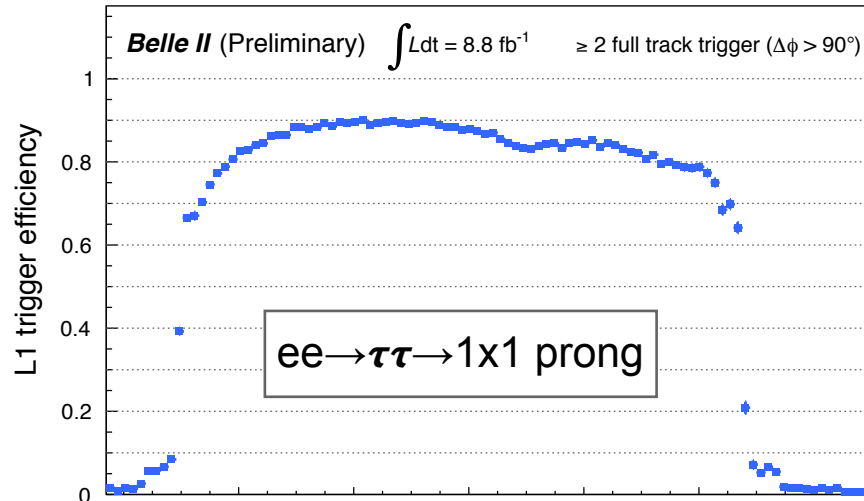

- L1 requirement
    - $\geq 2$  full tracks
    - track pair with  $\Delta\phi > 90^\circ$
    - ECL Bhabha veto
- ⇒ low efficiency in endcaps, puts limitations on tau + other low multi physics

- L1 requirement
    - $\geq 3$  full tracks
- ⇒ less severe drop in endcaps and at low  $p_T$  (due to one track redundancy)



# Trigger definitions

- **ffo** :  $\geq 2$  full tracks, track pair with  $\Delta\phi > 90^\circ$  and not an ECL Bhabha.
- **fff** :  $\geq 3$  full tracks.
- **fso** :  $\geq 1$  full tracks,  $\geq 1$  short tracks, track pair with  $\Delta\phi > 90^\circ$  and not an ECL Bhabha.
- **sso** :  $\geq 2$  short tracks, track pair with  $\Delta\phi > 90^\circ$  and not an ECL Bhabha.
- **ffs** :  $\geq 2$  full tracks and  $\geq 1$  short tracks.
- **fss** :  $\geq 1$  full tracks and  $\geq 2$  short tracks.
- **sss** :  $\geq 3$  short tracks.
- **hie** : total energy above 1 GeV and not an ECL Bhabha.
- **c4** :  $\geq 4$  isolated clusters with energy above 100 MeV and not an ECL Bhabha.
- **eclmumu** : cluster pair each with  $E^* < 2$  GeV,  $165^\circ < \sum\theta < 190^\circ$  and  $160^\circ < \Delta\phi < 200^\circ$ .

# Trigger definitions

- **lml0** :  $\geq 3$  clusters with at least one having  $E^* > 300$  MeV,  $1 < \theta_{ID} < 17$  (corresponding to  $18.5^\circ < \theta < 139.3^\circ$ , full ECL) and not an ECL Bhabha.
- **lml1** : exactly 1 cluster with  $E^* > 2$  GeV and  $4 < \theta_{ID} < 14$  ( $32.2^\circ < \theta < 124.6^\circ$ )
- **lml2** :  $\geq 1$  cluster with  $E^* > 2$  GeV,  $\theta_{ID} = 2, 3, 15,$  or  $16$  ( $18.5^\circ < \theta < 32.2^\circ$  or  $124.6^\circ < \theta < 139.3^\circ$ ) and not an ECL Bhabha.
- **lml4** :  $\geq 1$  cluster with  $E^* > 2$  GeV,  $\theta_{ID} = 1$  or  $17$  ( $\theta < 18.5^\circ$  or  $\theta > 139.3^\circ$ ) and not an ECL Bhabha.
- **lml6** : exactly 1 cluster with  $E^* > 1$  GeV,  $4 < \theta_{ID} < 15$  ( $32.2^\circ < \theta < 128.7^\circ$ , full ECL barrel) and no other cluster with  $E > 300$  MeV anywhere.
- **lml7** : exactly 1 cluster with  $E^* > 1$  GeV,  $\theta_{ID} = 2, 3$  or  $16$  ( $18.5^\circ < \theta < 31.9^\circ$  or  $128.7^\circ < \theta < 139.3^\circ$ ) and no other cluster with  $E > 300$  MeV anywhere.
- **lml8** : cluster pair with  $170^\circ < \Delta\phi < 190^\circ$ , both clusters with  $E^* > 250$  MeV and no 2 GeV cluster in the event.
- **lml9** : cluster pair with  $170^\circ < \Delta\phi < 190^\circ$ , one cluster with  $E^* < 250$  MeV with the other having  $E^* > 250$  MeV, and no 2 GeV cluster in the event.
- **lml10** : cluster pair with  $160^\circ < \Delta\phi < 200^\circ$ ,  $160^\circ < \sum\theta < 200^\circ$  and no 2 GeV cluster in the event.
- **lml12** :  $\geq 3$  clusters with at least one having  $E^* > 500$  MeV,  $2 < \theta_{ID} < 16$  (corresponding to  $18.5^\circ < \theta < 139.3^\circ$ , full ECL) and not an ECL Bhabha.