

R(D(*)) & $B \rightarrow \ell \nu(\gamma)$ from Belle & Prospects with Belle II



Milind Purohit

OIST, USC

for the Belle II collaboration

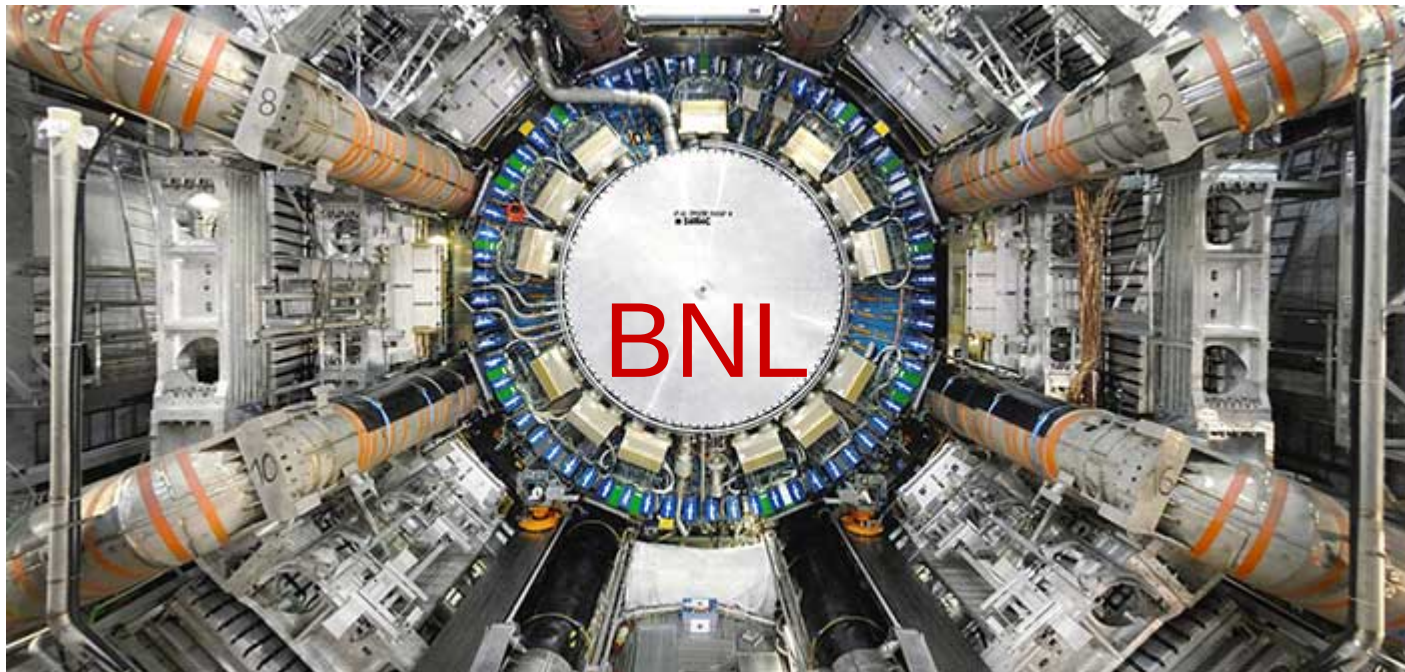

R(D(*)) & $B \rightarrow \ell \nu(\gamma)$ from Belle & Prospects with Belle II

Milind Purohit (OIST, USC, for the Belle II collaboration)



Tsukuba, Japan

Outline

- The Belle II Detector
- The KEKB & SuperKEKB accelerators
- R(D(*)) measurements, Belle, and extrapolations to Belle II
- $B \rightarrow \ell \nu(\gamma)$ from Belle, and extrapolations to Belle II

Belle II at KEK, Tsukuba, Japan

- ◆ The Belle II experiment is part of a broad-based search for new physics in the intensity frontier
- ▶ Precisely measuring particle collisions and comparing with theory
- ◆ The SuperKEKB accelerator upgrade will provide 40x the luminosity of KEKB and 50x the data taken with Belle

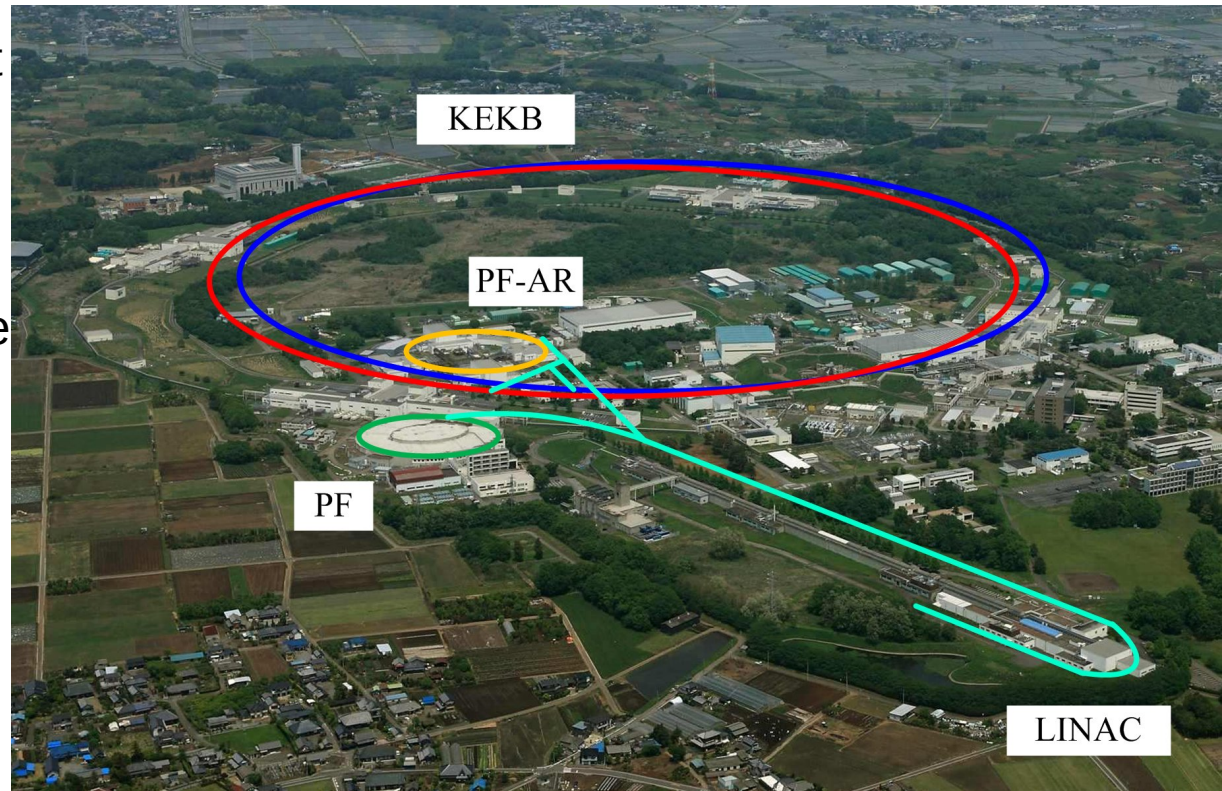

- ▶ Electrons and positrons will collide to provide useful events $>30,000$ times per second. The detector needs to detect the resulting particles, send the data to server farms, and store it for analysis.

[In figure: PF-AR = Photon Factory Advanced Ring]

The Belle II Detector

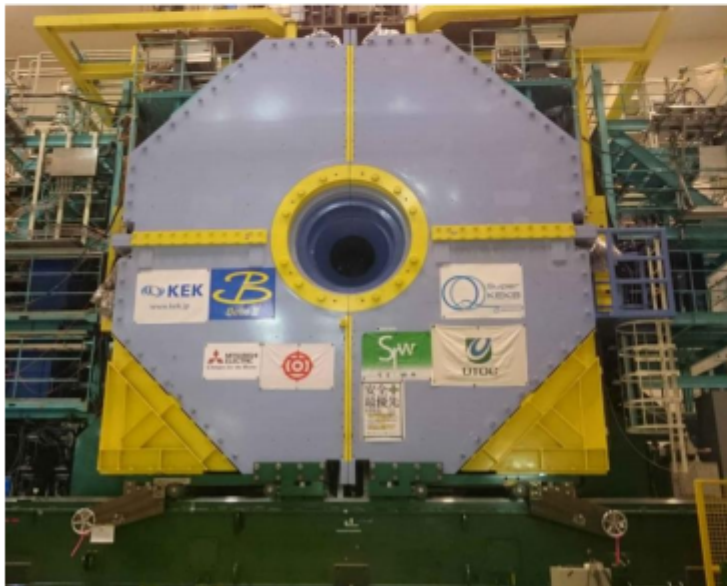
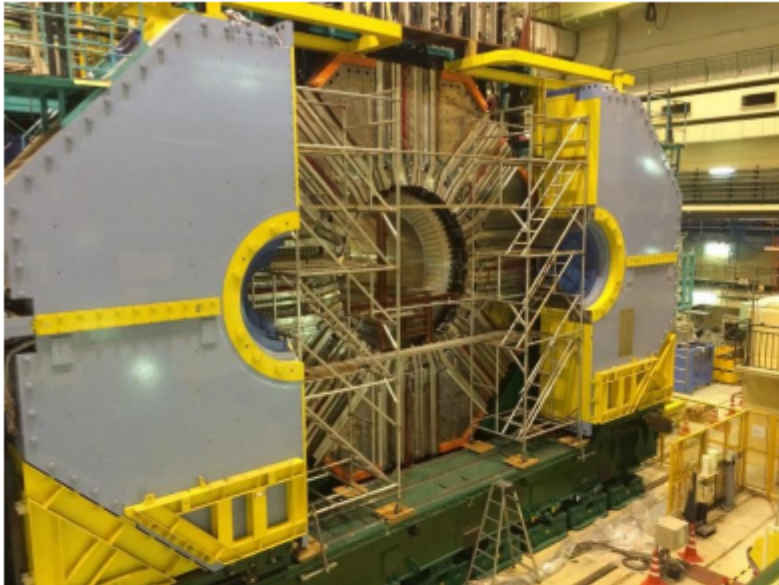

09/22/19

MV Purohit, BNL Lattice 2019

The Belle II Detector

● <https://www.youtube.com/watch?v=nGCrrgXSEOk>

▶ Complimentary subdetectors are used to identify and measure different particles

■ Silicon pixel and strip detectors around the collision point

■ Gas “drift chamber” tracks particles, measures momentum

■ **An imaging detector further identifies particle type**

■ Crystal-based calorimeters measure the particle energy

■ **The K_L/μ detector identifies particular particle types that pass through all the other detectors**

➡ [Except for the K_L/μ detector]

■ All of this in a 1.5T magnetic field generated by a solenoid large enough to park a car in...

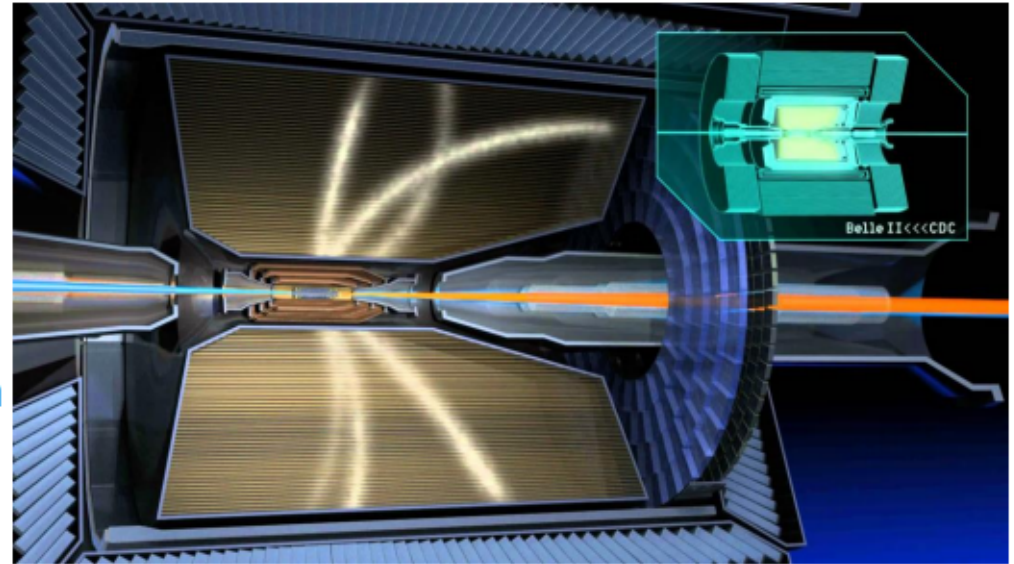

<https://www.youtube.com/watch?v=nGCrrgXSEOk>

Belle II Engineering Challenges

- ▶ Detectors are state-of-the-art, high-performance devices
 - Silicon, gas, optical, electronic...
 - About 8.4 million data channels into the DAQ system
- ▶ Detectors need physical support (in the magnetic field!), electrical (both HV and LV), gas, cooling, data transmission...
- ▶ Space constraints are extreme
- ▶ High radiation environment!
[n flux @ECL is $\approx 10^{12}$ /cm²]
- ▶ Working at an international laboratory with a very different culture!

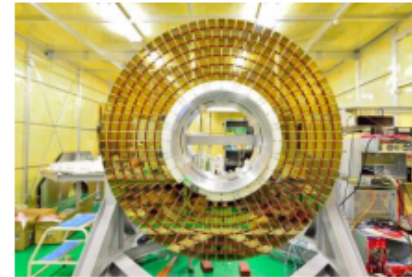
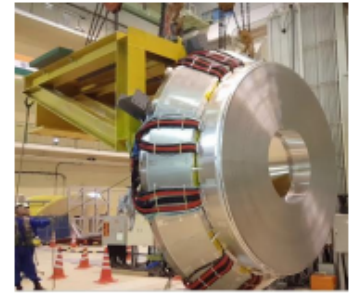
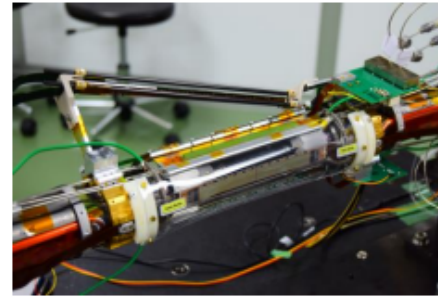

Belle II Data Acquisition & Computing

- ▶ Data needs to be collected at 30kHz event rate from all the subdetectors and assembled into event data in real time and stored for later processing

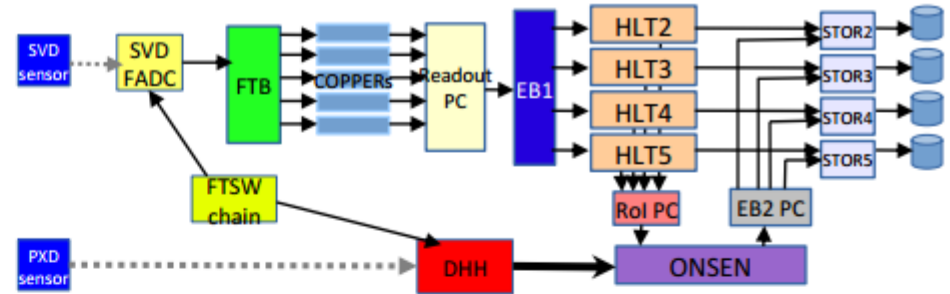

- Data streaming, real-time computing, parallel operations

By 2023: Events ≤ 100 kB each; ~ 663 kHEPSpec CPU; ~ 71 PB tape, 42 PB disk

- ▶ Raw data is processed into data used for physics analysis by computing at grid sites around the world

- Data management and transfer, job distribution and management, resource availability tracking, system redundancy

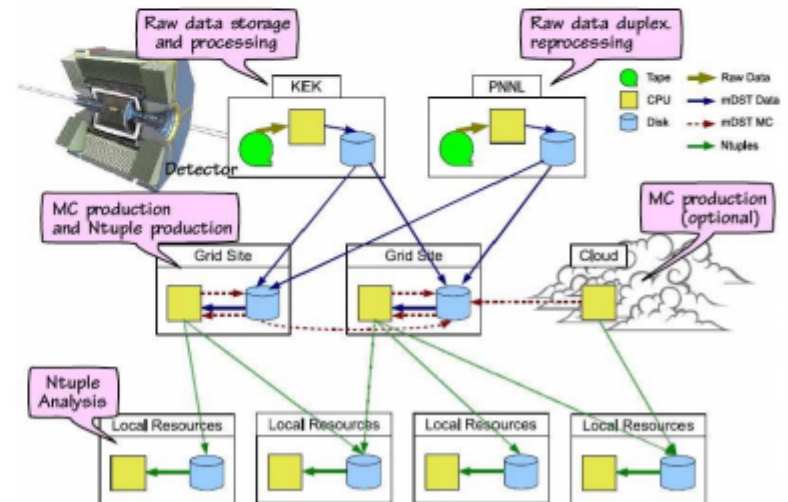

Belle II: The TOP Subdetector

- ▶ The “imaging Time of Propagation” (iTOP) detector identifies particle types by measuring the arrival times of photons generated by particles that traverse the detector

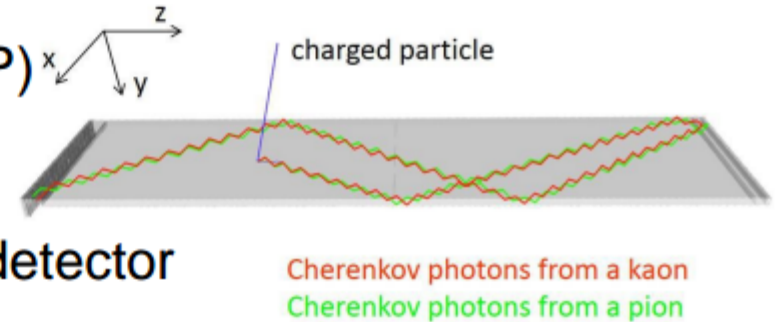

- ▶ Requirements:
 - Precisely machined quartz bars that are glued together perfectly
 - Light-tight “bar box” that supports the quartz securely without causing stress on the quartz
 - 5000+ channels of pixelated readout with picosecond timing resolution
 - Custom buffered waveform ASICs for readout
 - On-board FPGAs (4) to transfer waveforms to 5th “feature extraction” FPGA that extracts signal size and timing and sends it to back-end DAQ
 - Build 16 of these
- ▶ And all of this assembled into a detector where they will be inaccessible for 5-10 years... but need to operate without problems!

Belle II: TOP Mechanics

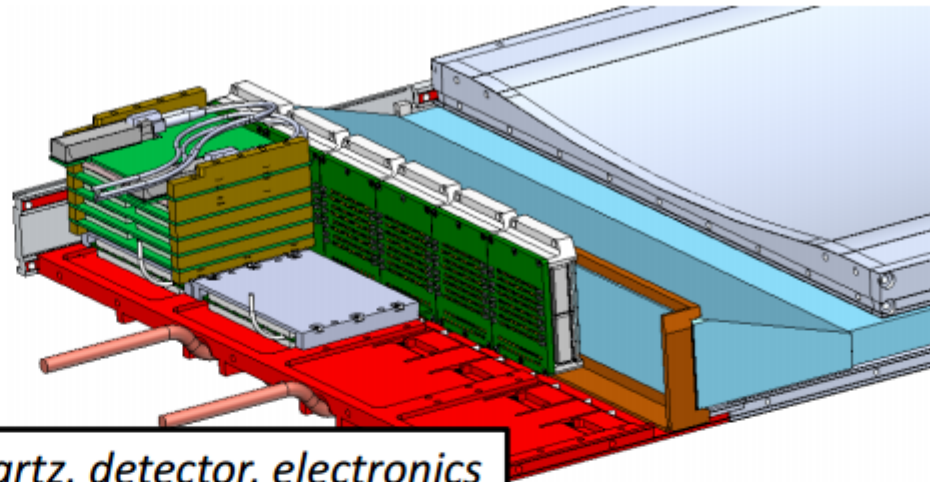
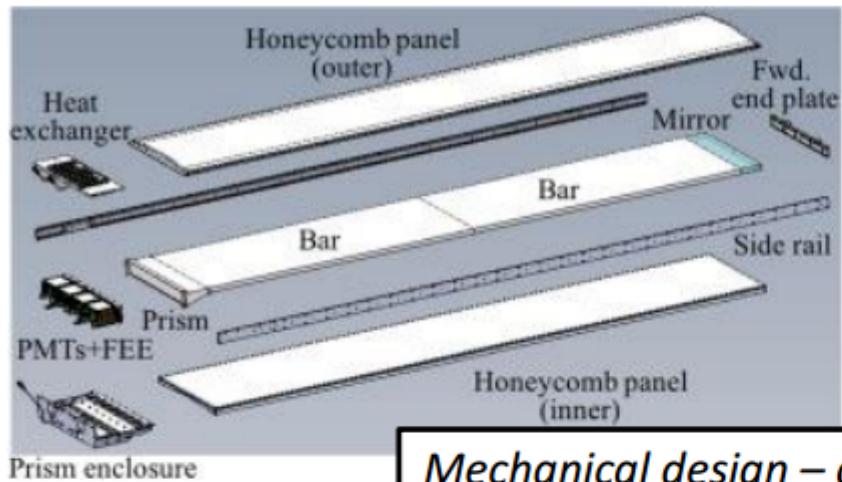

Mechanical design – quartz, detector, electronics

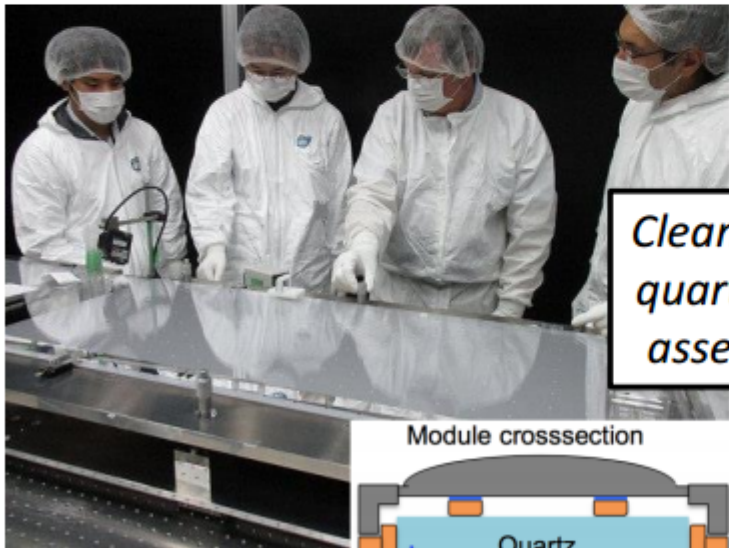

Cleanroom quartz bar assembly

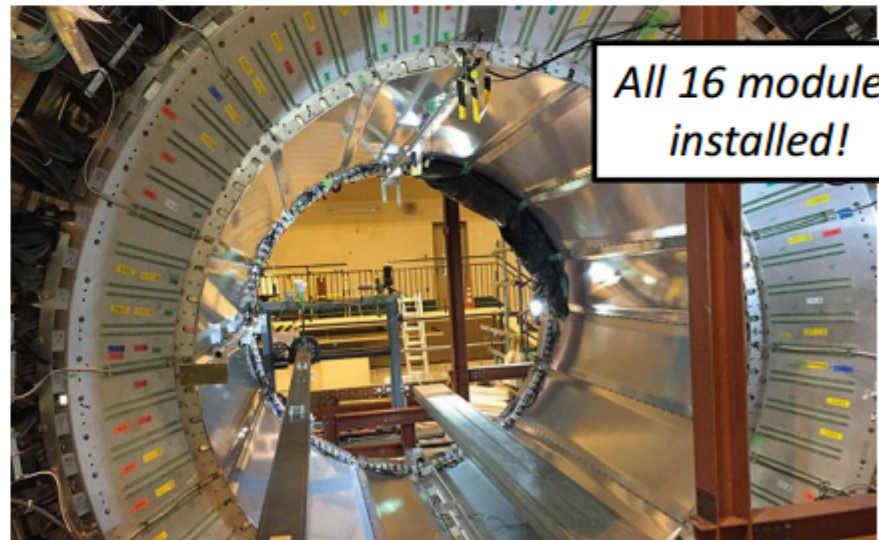
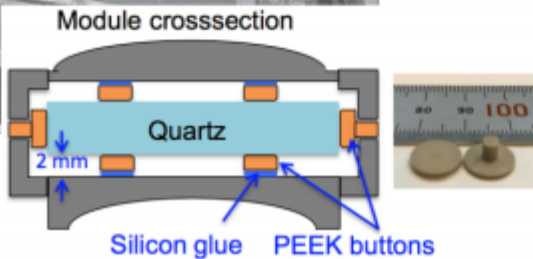

All 16 modules installed!

Belle II: TOP Electronics and Firmware

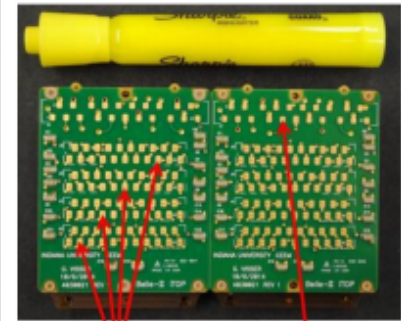
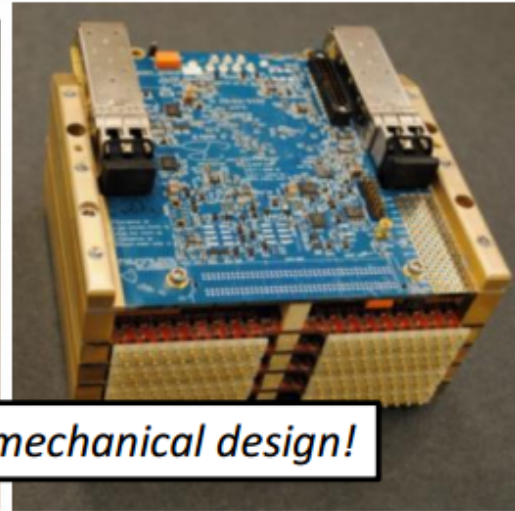
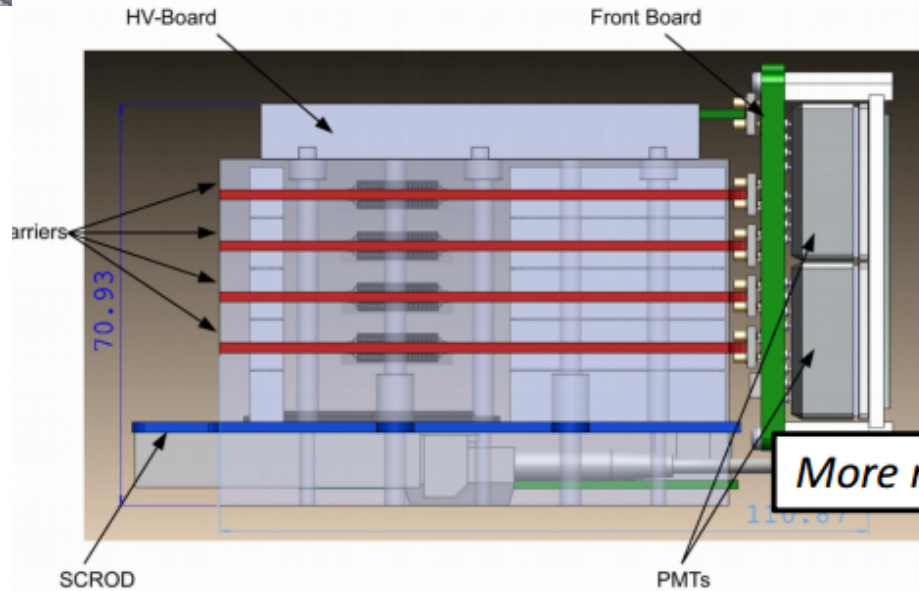

contact pads for ASIC carrier pogo pins

contact pads for HV board pogo pins

More mechanical design!

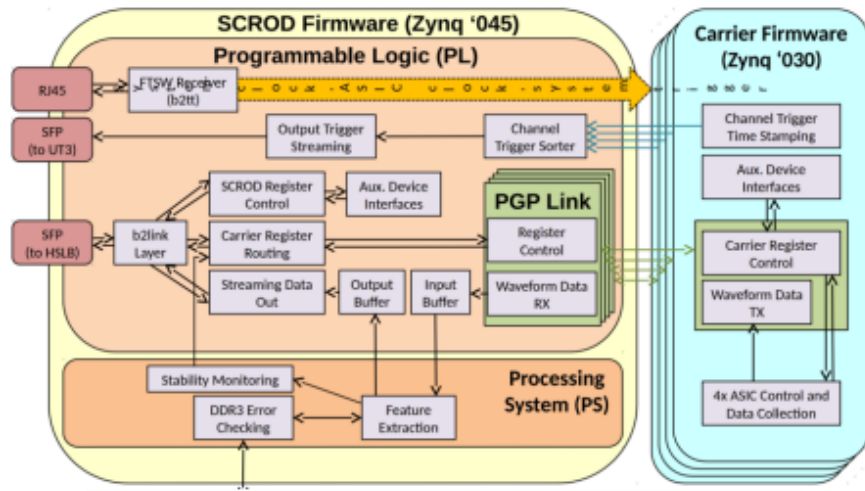

Multi-FPGA firmware development

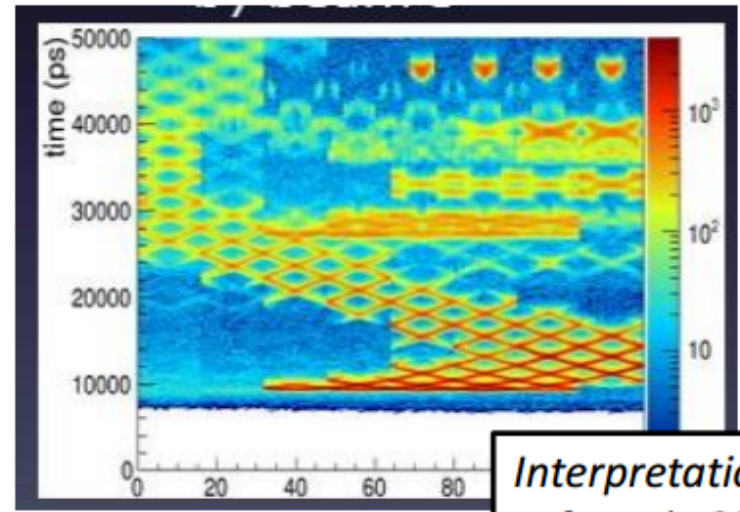

Interpretation of results?!?

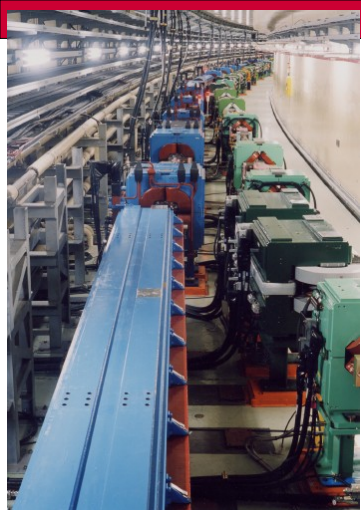

2017: Accelerator operational,
Studying beam backgrounds

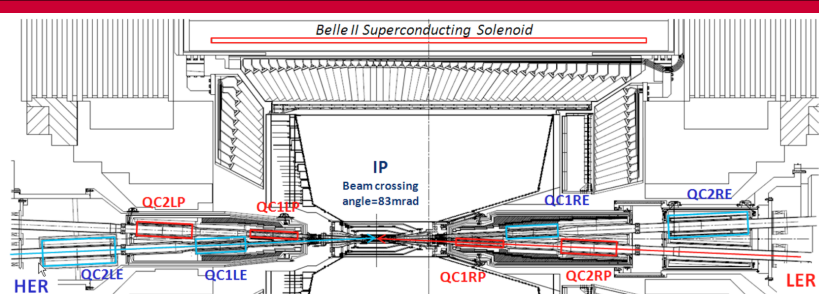

8 new SC final focusing magnets near the IP: 2017.

$e^+ 3.6A$

KEKB →
SuperKEKB

$e^- 2.6A$

- ◆ Nano-Beam scheme
extremely small β_y^*
low emittance
- ◆ Beam current x2

$$\mathcal{L} = \frac{\gamma_{\pm}}{2er_e} \left(1 + \frac{\sigma_y^*}{\sigma_x^*} \right) \frac{I_{\pm} \xi_{y\pm}}{\beta_{y\pm}^*} \frac{R_L}{R_{\xi_y}}$$

40x higher \mathcal{L} than KEKB!

Reduce emittance (longer dipoles, more wiggler cycles)
(all magnets installed 8/2014)



Alignment work complete.

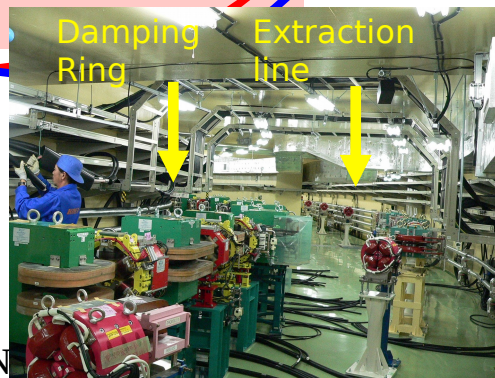

Low emittance
RF electron gun

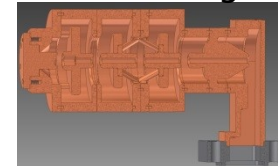

Parameters for KEKB and SuperKEKB



	KEKB Design	KEKB with crab	SuperKEKB Nano-Beam
Energy (GeV) (LER/HER)	3.5/8.0	3.5/8.0	4.000/7.007
β_y^* (mm)	10/10	5.9/5.9	0.27/0.30
β_x^* (mm)	330/330	1200/1200	32/25
ϵ_x (nm)	18/18	18/24	3.2/4.6
ϵ_y (pm)	180/180	153/154	8.64/11.5
σ_y (nm)	1900	940	48/62
σ_z (mm)	4	6 - 7	6/5
I_{beam} (A)	2.6/1.1	1.64/1.19	3.6/2.6
N_{bunches}	5000	1584	2500
Luminosity ($10^{34} \text{ cm}^{-2} \text{ s}^{-1}$)	1	2.11	80



Nano-beams are key ($\sigma_y \sim 50\text{nm} !!$). Also, lower boost reduces Touschek effect losses, especially in the LER.

The Belle II Detector

Physics Data
in 2017!

EM Calorimeter: CsI(Tl), waveform
sampling (barrel + end-caps)

K_L and muon detector:
Resistive Plate Counter (barrel)
Scintillator + WLSF + MPPC (end-caps)

Particle Identification
Time-of-Propagation counter (barrel)
Prox. focusing Aerogel RICH (fwd)

electron (7 GeV)

Beryllium beam pipe
2cm diameter

positron (4GeV)

Vertex Detector: 2 layers pixels
(DEPFET) + 4 layers 2-sided Si
(DSSD).

Central Drift Chamber
He(50%):C₂H₆(50%), Small cells,
long lever arm, fast electronics

Belle II Strengths:

- Neutrals, incl missing E (ν etc.), π^0 , ... esp. analyses with many kinematic variables
- Many-particle decay modes
- Entangled state production
 - Tagging using other B



Belle II: Guarded Guess on Improvement over Belle

<u>Performance measure</u>	<u>Comparison</u>
Tracking & Vertexing	New Pixel Detector Improved CDC dE/dx should improve Tracking efficiency should not degrade Vertexing resolutions should be x2 better
PID	Time-Of-Propagation (TOP: barrel) does TOF & TOP Aerogel RICH (ARICH: forward) Less material in front of the calorimeter Hadron ID should improve at all momenta
Electromagnetic Calorimeter (ECL)	Waveform sampling technique to cope with increased background. Photon resolution should be just as good as Belle
K_L^0 - μ detector (KLM)	RPC's in endcaps and first two layers of barrel replaced with scintillator counters to cope with increased neutron background.
Lepton ID	Lepton ID should be just as good as Belle

BF(B⁺ → D(*)τν): Status ~ 3 yrs ago

★ The Belle, BaBar collaborations studied B semileptonic decays and found evidence for LFV [B3-1, B3-2] in the ratios

★ $R(D^{(*)}) \equiv \text{BF}(B^+ \rightarrow D^{(*)}\tau\nu) / \text{BF}(B^+ \rightarrow D^{(*)}\ell\nu)$. Since then, measurements were available also from Belle and LHCb:

	$R(D)$	$R(D^*)$
BaBar	$0.440 \pm 0.058 \pm 0.042$	$0.332 \pm 0.024 \pm 0.018$
Belle	$0.375^{+0.064}_{-0.063} \pm 0.026$	$0.293^{+0.039}_{-0.037} \pm 0.015$
LHCb		$0.336 \pm 0.027 \pm 0.030$
Average	0.388 ± 0.047	0.321 ± 0.021
SM expectation	0.300 ± 0.010	0.252 ± 0.005
Belle II, 50/ab	± 0.010	± 0.005

★ As is clear from the table, Belle II will improve the uncertainty considerably on these measurements, making for a meaningful comparison with the SM and firmly establishing (or not) an excess.

★ It is important to measure differential rates to establish the nature of deviations from the SM.[TH-3]

- B3-1. A. Bozek *et al.*, PRD 82, 072005 (2010).
- B3-2. J.P. Lees *et al.*, PRD 88, 072012 (2013).
- TH-3. S. Fajfer, J.F. Kamenik, I. Nisandzik, PRD 85, 094025 (2012).

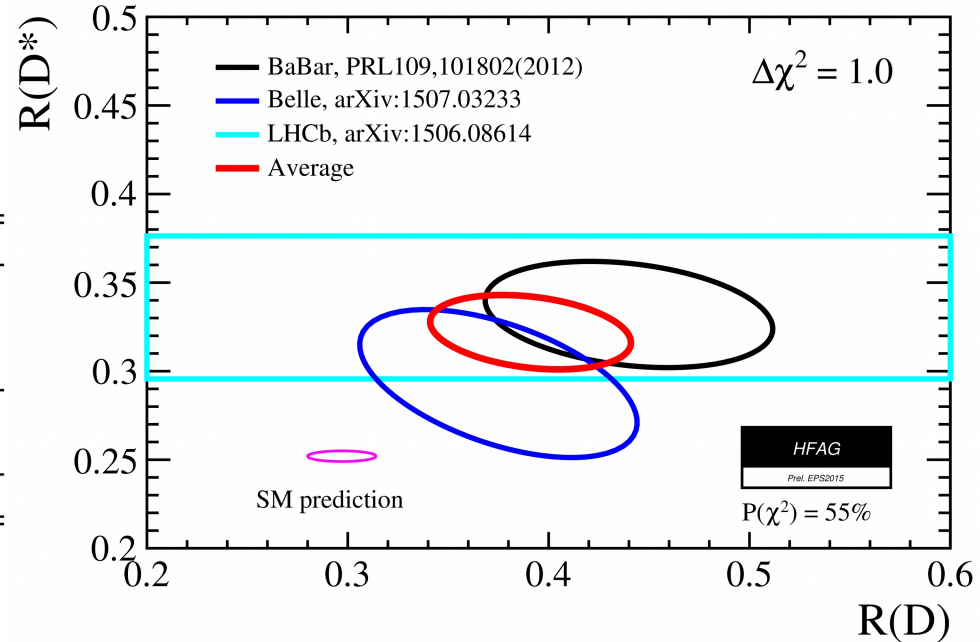

The combined $R(D)$ and $R(D^*)$ result exceeds the SM predictions at 3.9σ level, with a p -value of 1.1×10^{-4} . The $R(D)$ and $R(D^*)$ correlation of -0.29 is shown.

R(D(*)): further notes

- R(D(*)) is theoretically very clean: SM errors are small compared to experiment
- Could be a signal of new (virtual) heavy particles
- Events are tagged inclusively either by fully reconstructed hadronic decays, or by semileptonic tagging. Full Event Information (FEI) will be used to increase efficiency of tags.
- The τ^- can decay either leptonically or to $\pi^- \nu$ or to $\rho^- \nu$
- Reconstruction is not easy due to at least two missing neutrinos, and backgrounds such as $B \rightarrow D^{*} l \nu$ decays are difficult to reduce. We hope to reduce these using excellent vertexing exploiting the tight beamspot in the y-direction and the tag-side B vertex and momentum.

$B \rightarrow D^* \tau \nu$: τ polarization & $R(D^*)$

- Belle, hadronic tags, 2017:

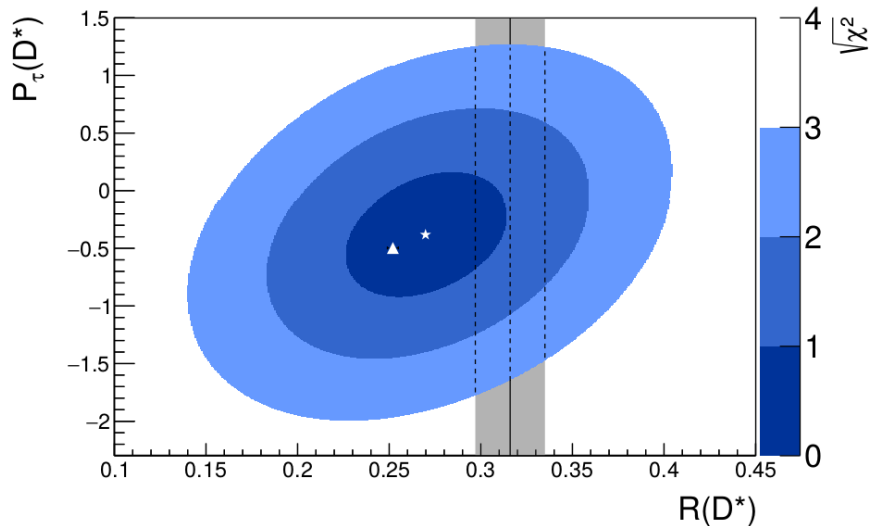

FIG. 10. Comparison of our result (star for the best-fit value and 1σ , 2σ , 3σ contours) with the SM prediction (triangle). The white region corresponds to $> 3\sigma$. The shaded vertical band shows the world average as of early 2016 [20].

We report the measurement of $R(D^*)$ with hadronic τ decay modes $\tau^- \rightarrow \pi^- \nu_\tau$ and $\tau^- \rightarrow \rho^- \nu_\tau$, and the first measurement of $P_\tau(D^*)$ in the decay $\bar{B} \rightarrow D^* \tau^- \bar{\nu}_\tau$, using 772×10^6 $B\bar{B}$ data accumulated with the Belle detector. Our results are

$$R(D^*) = 0.270 \pm 0.035(\text{stat})_{-0.025}^{+0.028}(\text{syst}), \quad (21)$$

$$P_\tau(D^*) = -0.38 \pm 0.51(\text{stat})_{-0.16}^{+0.21}(\text{syst}), \quad (22)$$

which are consistent with the SM predictions. The result excludes $P_\tau(D^*) > +0.5$ at 90% C.L. This is the first measurement of the τ polarization in the semitaonic decays, providing a new dimension in the search for NP in semitaonic B decays.

$B \rightarrow D\tau\nu$: sl tags

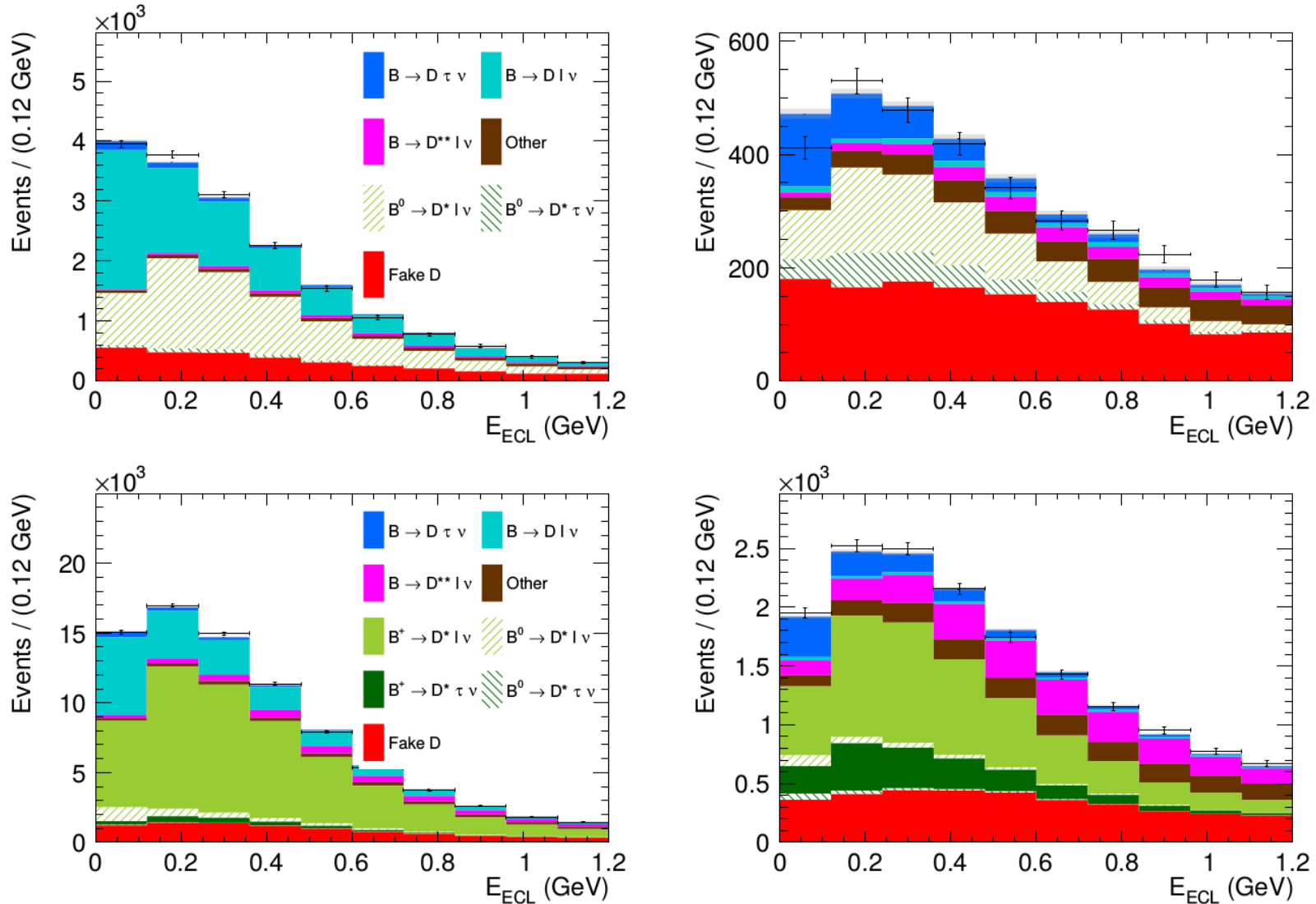

FIG. 2. E_{ECL} fit projections and data points with statistical uncertainties in the $D^+\ell^-$ (top) and $D^0\ell^-$ (bottom) samples, for the full classifier region (left) and the signal region defined by the selection `class > 0.9` (right).

$B \rightarrow D^* \tau \nu$: sl tags

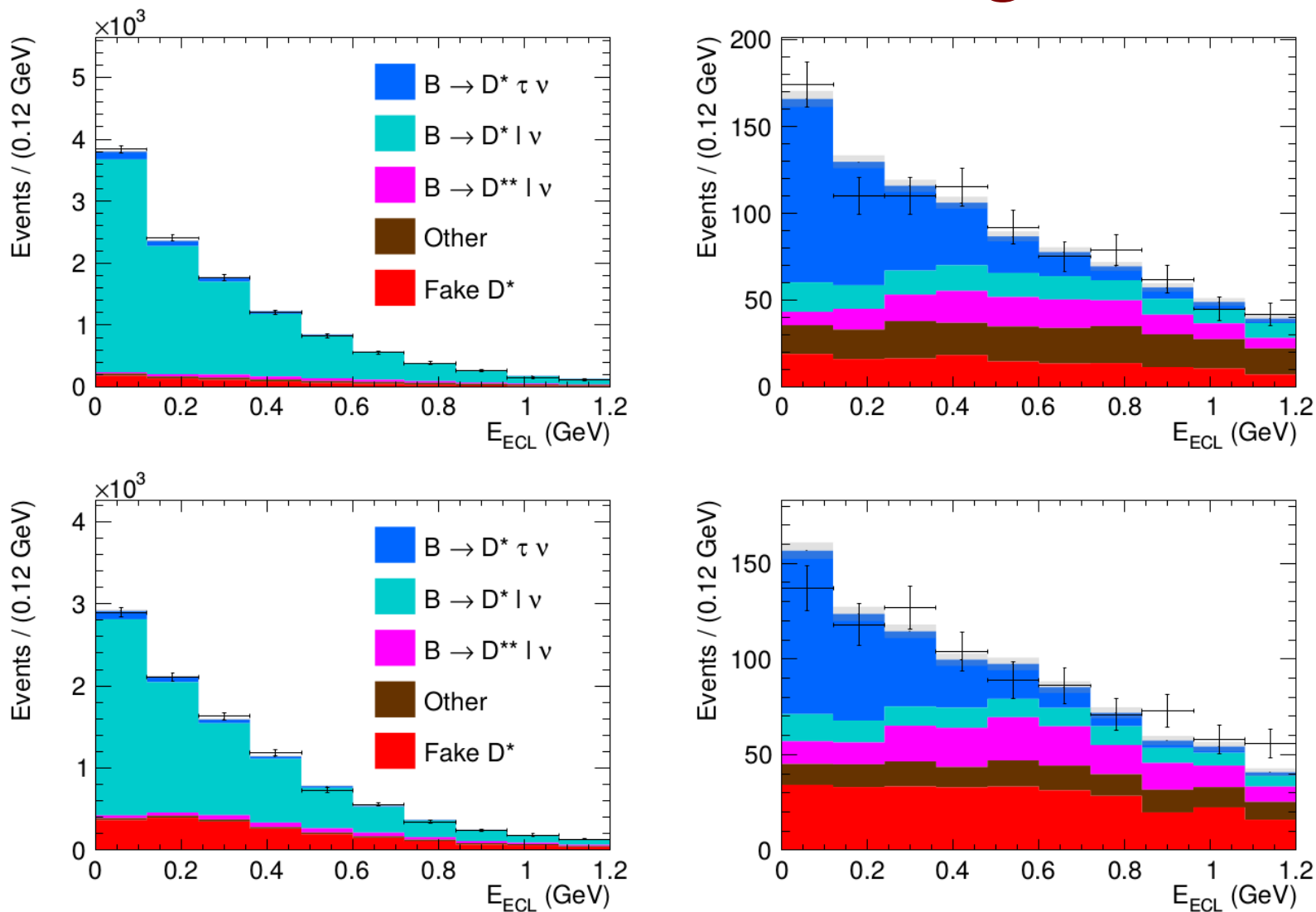

FIG. 3. E_{ECL} fit projections and data points with statistical uncertainties in the $D^{*+} \ell^-$ (top) and $D^{*0} \ell^-$ (bottom) samples, are shown for the full classifier region (left) and the signal region defined by the selection $\text{class} > 0.9$ (right).

R(D^{*}): HFLAV 2019 references

Average of R(D) and R(D^{*+}) for Spring 2019

- BaBar Collaboration: Phys.Rev.Lett 109, 101802 (2012) [arXiv:1205.5442] and Phys.Rev.D 88, 072012 (2013) [arXiv:1303.0571]

Combined measurement of R(D) and R(D^{*+}) based on the hadronic tagging sample and it is a combined. We use the results obtained imposing the isospin relations R(D⁰)=R(D⁺) and R(D^{*0})=R(D^{*+}).

- Belle Collaboration: Phys.Rev. D92, 072014 (2015) [arXiv:1507.03233]

Similar to the BaBar analysis: combined measurement of R(D) and R(D^{*}), based on the hadronic tagging sample.

- LHCb Collaboration: Phys.Rev.Lett. 115, 111803 (2015), Addendum: Phys.Rev.Lett. 115, 159901 (2015) [arXiv:1506.08614]

Measurement of R(D^{*+}). Only the $\tau \rightarrow \mu \nu \mu \nu \tau$ decay mode is used.

- Belle Collaboration: Phys.Rev.Lett. 118, 211801 (2017) [arXiv:1612.00529] and Phys.Rev.D 97, 012004 (2018) [arXiv:1709.00129]

Measurement of R(D^{*+}) based on an hadronic tagging sample. The τ is reconstructed in the hadronic decay channels $\tau \rightarrow \pi \nu$ and $\tau \rightarrow \rho \nu$. This is a simultaneous measurement of R(D^{*}) and the τ polarization.

- LHCb Collaboration: Phys.Rev.Lett. 120, 171802 (2018) [arXiv:1708.08856] and Phys.Rev.D 97, 072013 (2018) [arXiv:1711.02505]

Measurement of R(D^{*+}) where τ is reconstructed in the three-prong hadronic decay channels $\tau \rightarrow 3\pi(\pi^0)\nu$. This measurement has been updated to the latest HFLAV average of $BF(B^0 \rightarrow D^{*+} l^- \nu) = 5.08 \pm 0.02 \pm 0.12 \%$.

- Belle Collaboration: Preliminary result presented at Moriond EW 2019 [arXiv:1904.08794]

Combined measurement of R(D) and R(D^{*+}), based on a semileptonic tagging method. This supersedes the published measurement: Phys.Rev. D94, 072007 (2016) [arXiv:1607.07923]

- In the average we assume 100% correlation for the systematic uncertainties associated with the D^(*) form factors, the D^{**} composition and shapes, and the τ branching fractions. The other uncertainties are considered uncorrelated between the various experiments.

R(D) measurements (HFLAV)

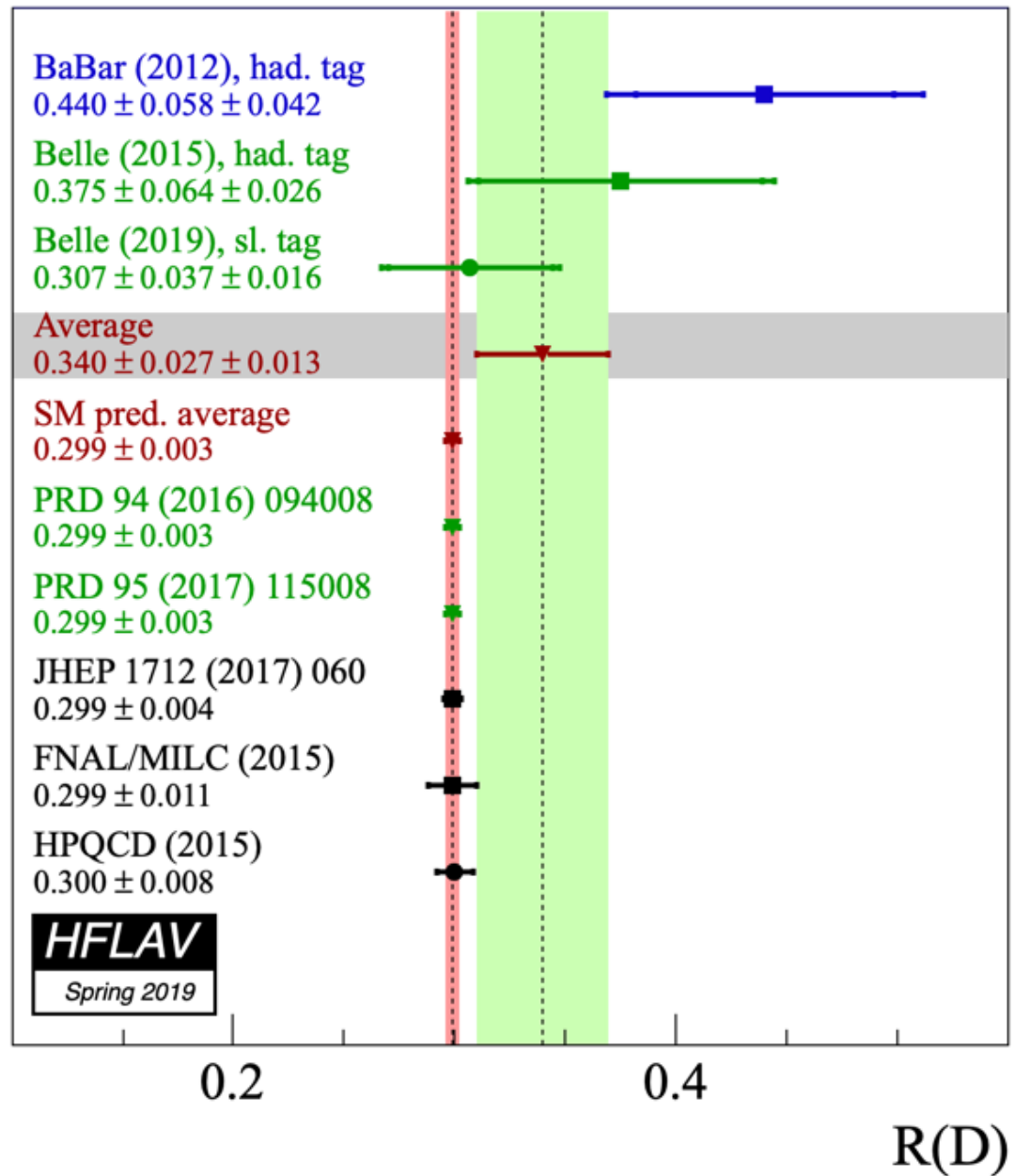

R(D*) measurements (HFLAV)

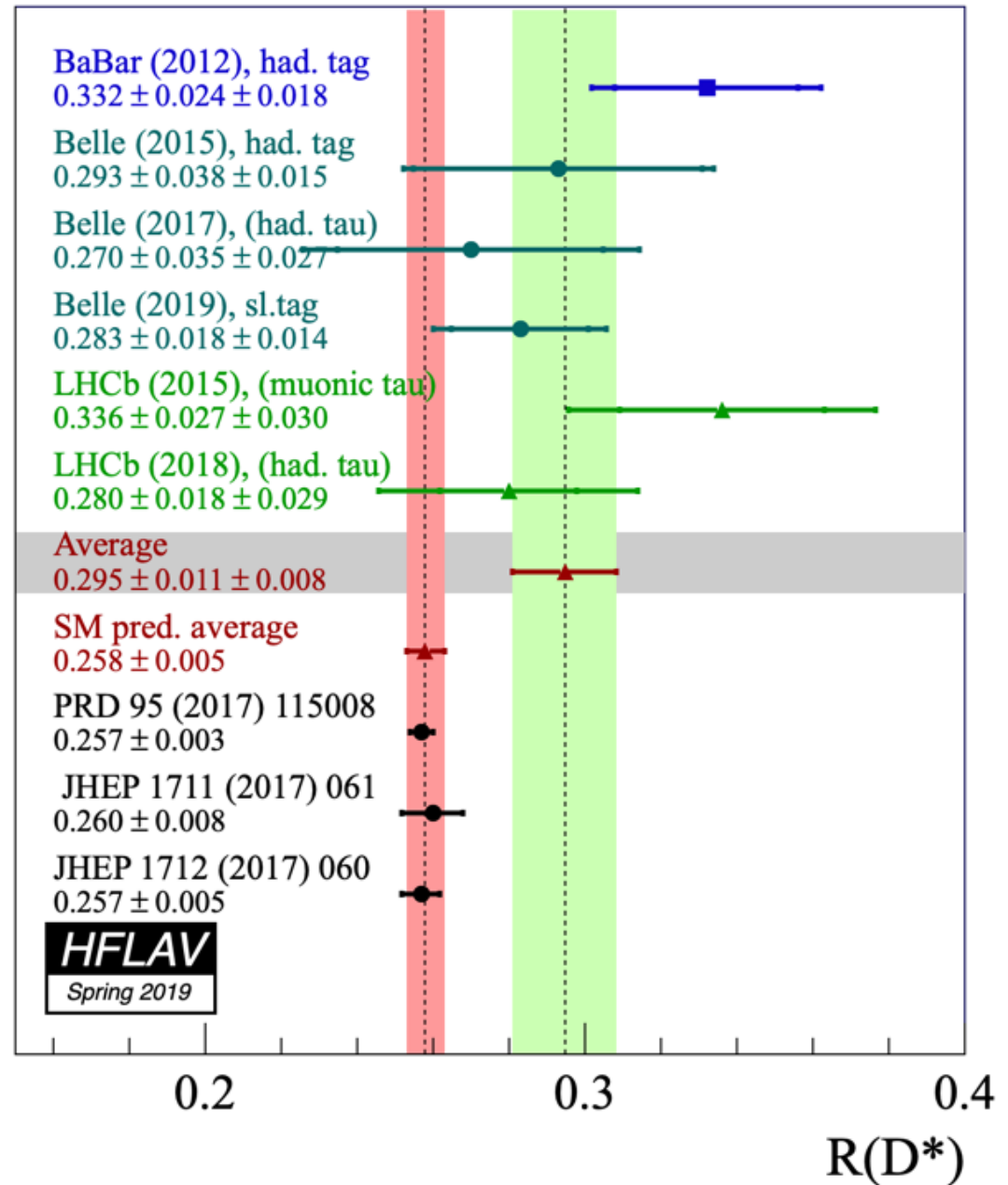

R(D^{*}): HFLAV

Theory (SM) references

	R(D)	R(D [*])
D.Bigi, P.Gambino, Phys.Rev. D94 (2016) no.9, 094008 [arXiv:1606.08030 [hep-ph]]	0.299 ± 0.003	
F.Bernlochner, Z.Ligeti, M.Papucci, D.Robinson, Phys.Rev. D95 (2017) no.11, 115008 [arXiv:1703.05330 [hep-ph]]	0.299 ± 0.003	0.257 ± 0.003
D.Bigi, P.Gambino, S.Schacht, JHEP 1711 (2017) 061 [arXiv:1707.09509 [hep-ph]]		0.260 ± 0.008
S.Jaiswal, S.Nandi, S.K.Patra, JHEP 1712 (2017) 060 [arXiv:1707.09977 [hep-ph]]	0.299 ± 0.004	0.257 ± 0.005
Arithmetic average (not sanctioned by authors)		0.258 ± 0.005

R(D) and R(D^{*}) exceed the SM predictions given in the last row of the table above, by 1.4σ and 2.5σ respectively. Considering the R(D)-R(D^{*}) correlation of -0.38, the resulting combined χ² is 12.33 for 2 degree of freedom, corresponding to a p-value of 2.07 x 10⁻³. The difference with the SM predictions reported above, corresponds to about 3.08σ.

R(D^{*}) measurement average (HFLAV)

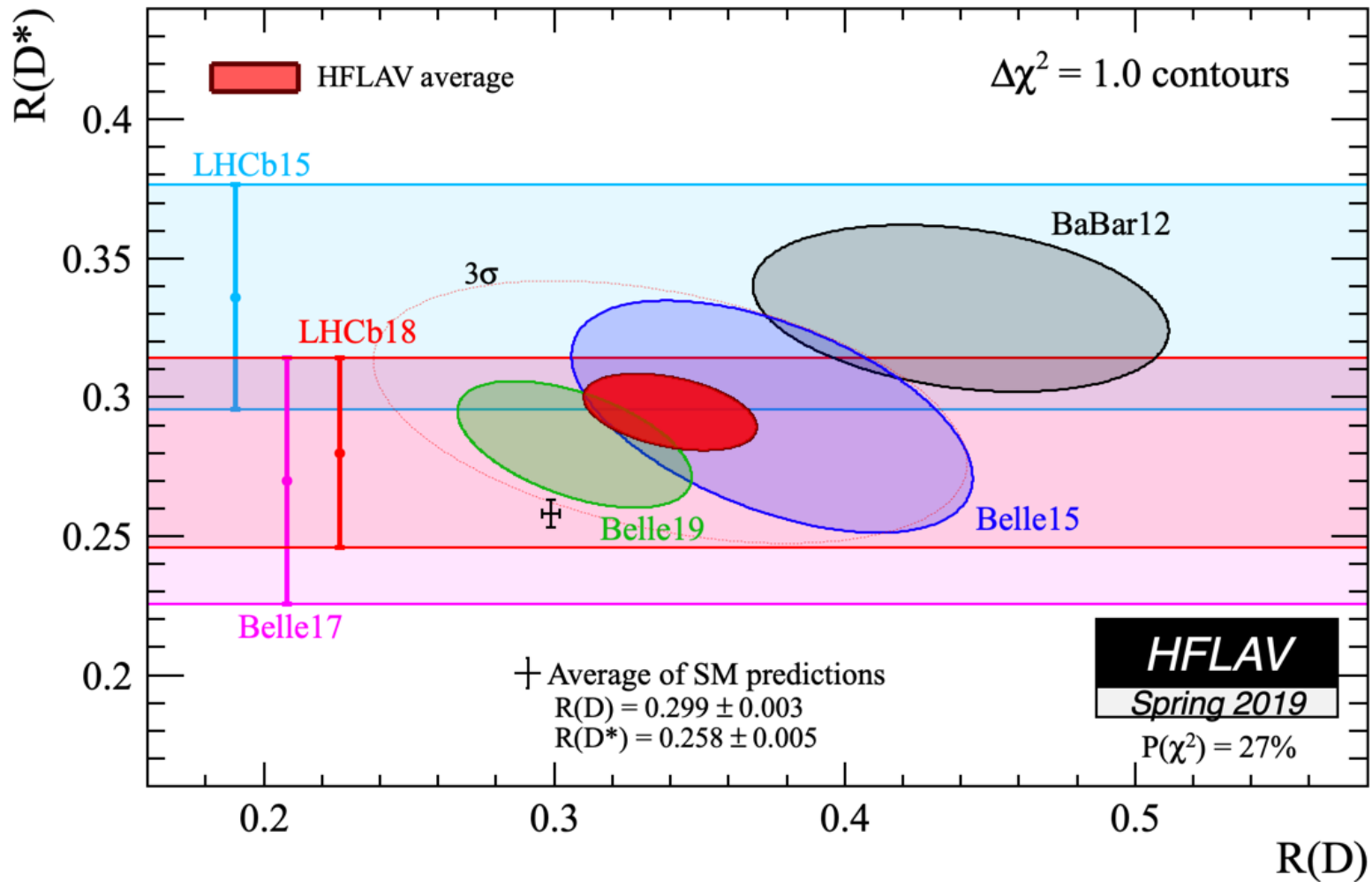

Summary of Belle II prospects for $R(D^{(*)})$

- New hadronic full reconstruction algorithm improves efficiency, improving time to discovery in Phase 3 physics prospects
- We calculate:
 - 5σ confirmation of $R(D^{(*)})$ anomalies at 5 ab^{-1}
 - 5σ significance of $B \rightarrow \tau\nu$ branching ratio at $1\text{-}3 \text{ ab}^{-1}$
 - SM observation of $B \rightarrow K^{(*)} \nu\bar{\nu}$ at $\sim 18\text{ab}^{-1}$

Total uncertainty	5 ab^{-1} (2020)	50 ab^{-1} (2025)
$R(D)$	6%	3%
$R(D^{*})$	3%	2%
$B \rightarrow \tau\nu$ with hadronic tag full reconstruction	15%	6%
$B \rightarrow \tau\nu$ with semileptonic tag full reconstruction		5%
$B \rightarrow K^{(*)} \nu\bar{\nu}$ modes (average)		10%

Note: These projections, made for ICHEP '18, assume the then larger anomalies.

Historical Aside

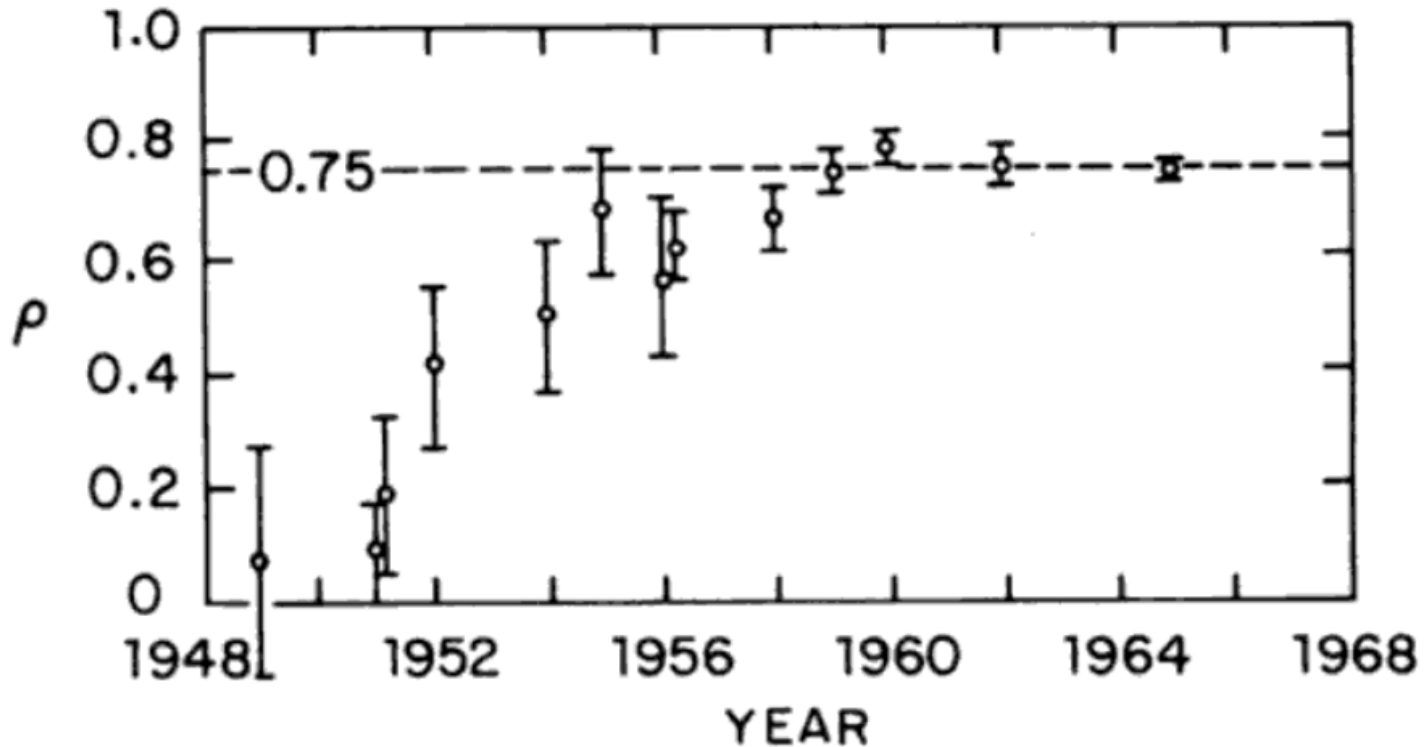

Figure 16. The change of the Michel parameter ρ from year to year.

From T. D. Lee's text

B → ℓν(γ) from Belle: Limit Calculation

Limit Calculation

Bayesian Limit

$$0.9 = \frac{\int_0^{\Delta\mathcal{B}_{\text{limit}}} \mathcal{L}_{\text{PDF}}(\Delta\mathcal{B}) d\Delta\mathcal{B}}{\int_0^{\infty} \mathcal{L}_{\text{PDF}}(\Delta\mathcal{B}) d\Delta\mathcal{B}}$$

ℓ	$\Delta\mathcal{B}(\text{B}^+ \rightarrow \ell^+ \nu_{\ell} \gamma) (\times 10^{-6})$ limit @90% C.L.		
	BaBar (2009) ^a	Belle (2015) ^b	This work
e	-	< 6.1	< 4.3
μ	-	< 3.4	< 3.4
e, μ	< 14	< 3.5	< 3.0

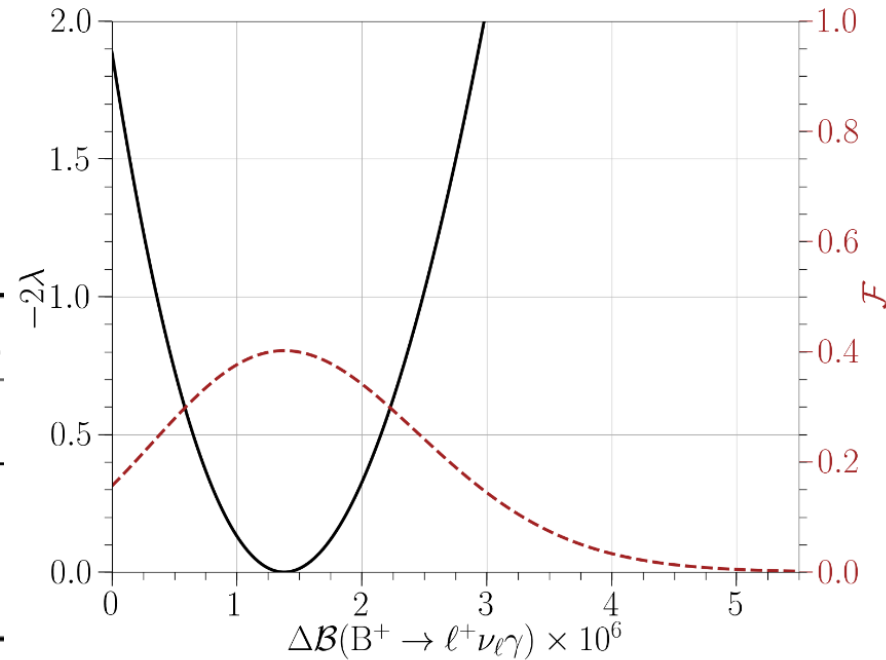

Limits are estimated with total systematic error.

a: Phys. Rev. D 80, 111105 (2009)

b: Phys. Rev. D 91, 112009 (2015)

$B \rightarrow \ell \nu(\gamma)$ from Belle: Extraction of λ_B

$$R_\pi = \frac{\Delta\mathcal{B}(B^+ \rightarrow \ell^+ \nu_\ell \gamma)}{\mathcal{B}(B^+ \rightarrow \pi^0 \ell^+ \nu_\ell)} = \frac{\Delta\Gamma(\lambda_B)}{\Gamma(B^+ \rightarrow \pi^0 \ell^+ \nu_\ell)}$$

$$R_\pi^{\text{measured}} = (1.7 \pm 1.4) \times 10^{-2}$$

	λ_B (GeV)
Model I	$0.36^{+0.25+0.03}_{-0.08-0.03}$
Model II	$0.38^{+0.25+0.05}_{-0.06-0.08}$
Model III	$0.32^{+0.24+0.05}_{-0.07-0.08}$

based on theoretical input from:

[Beneke et al., JHEP 07:154 \(2018\)](#)

[HFLAV, Eur. Phys. J., C77:895, \(2017\)](#)

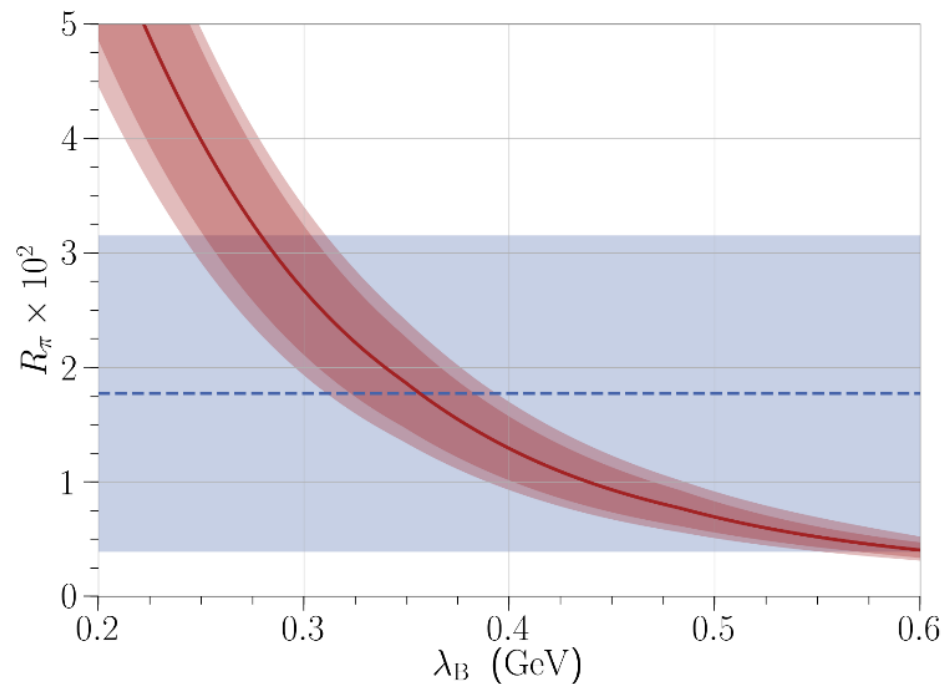

$\lambda_B > 0.24 \text{ GeV} \quad @ 90\% \text{ C.L.}$

Result of Belle (2015) was $\lambda_B > 0.238 \text{ GeV}$

$B \rightarrow \bar{l}\nu(\gamma)$ Prospects at Belle II

Analysis is **statistically limited**.

⇒ **Extrapolation for Belle II:**

- scale statistical uncertainty with luminosity: $\sqrt{711 \text{ fb}^{-1} / \mathcal{L}}$
- unchanged central value
- unchanged systematic uncertainty

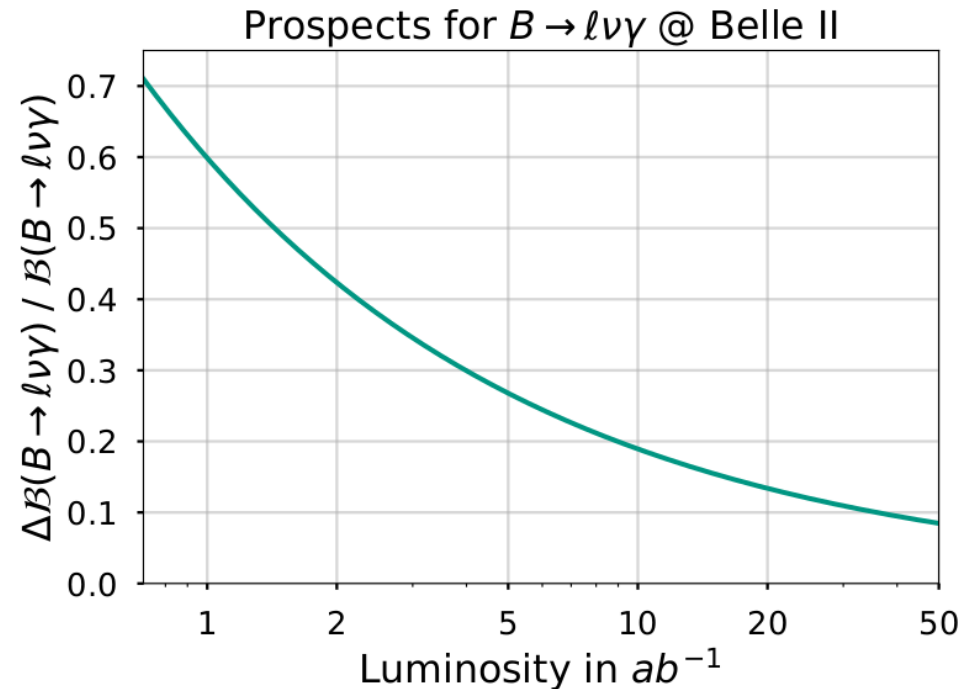

B \rightarrow $\bar{\nu}(\gamma)$ Prospects at Belle II

\Rightarrow Estimate improved statistical uncertainties for the full analysis

\Rightarrow Propagate results to V_{ub} and λ_B

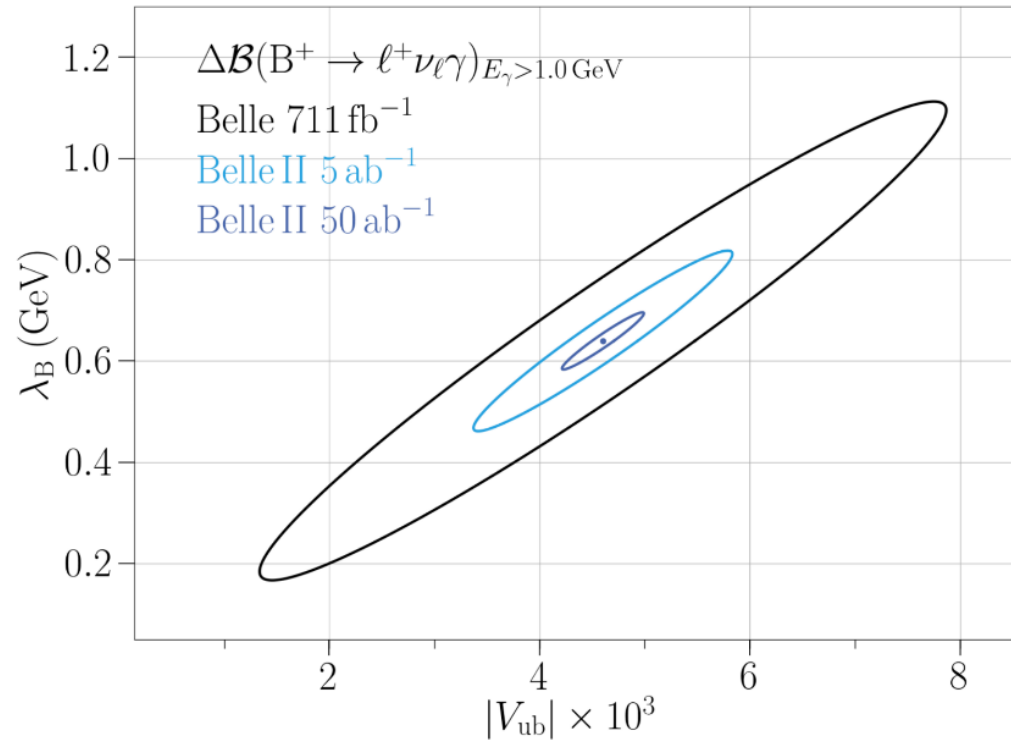

Conclusions

- The Belle II experiment is at the start of many years of data-taking, and hopes to get x50 data compared to Belle
- 3 years ago there was a 3.9σ discrepancy with SM predictions on $R(D)$ and $R(D^*)$
- Today this is only a 3.1σ discrepancy.
- The Belle-II experiment should improve the measurement uncertainties of both quantities by about x3 [x2 to x4], with the statistical errors dropping by \sim x5.
- Note that $R(D^{(*)})$ are not the only two observables. Besides P_T , there are also momentum and q^2 distributions.
- Belle II will conclusively say whether there is LF universality or not in these modes at the present discrepancy level.
- $B \rightarrow \ell \nu(\gamma)$ from Belle is statistically limited

Many thanks for slides / info from N. L. Braun, T. Browder, R. Cheaib, A. Gaz, S. Hollitt, T. Iijima, T. Kuhr, A. Loos, F. Metzner, K. Miyabayashi, L. Piilonen, A. Soffer, A. Schwartz, P. Urquijo, L. Wood and all members of the Belle II collaboration and KEK whose comments, papers, talks and other efforts have helped prepare this talk directly and indirectly.

Extra slides

Some SuperKEKB facts

- ▶ 7.007 GeV e^- on 4.000 GeV e^+
- ▶ Goal: Provide the highest luminosity collisions in the world.
Luminosity is measured in $\text{cm}^{-2} \text{s}^{-1}$
- ▶ Beams: ~ 50 nm in y , ~ 20 microns in x , ~ 5 mm in z
- ▶ 2500 bunches, each bunch provides ~ 1 mA
- ▶ Circumference = 3.016315 km, $T = 10.061$ micro-seconds
- ▶ Flat beams due to quantum fluctuations in synchrotron radiation
Final focus easier to design for flat beams
Beamstrahlung is lower
- ▶ Touschek losses (intra beam scattering; τ goes like $E^{4.5}/N$)
mitigated in LER by higher E , lower N
- ▶
- ▶ How does SuperKEKB get to such high \mathcal{L} ?
 - Raise the tune-shifts, collision frequency, nano-beams

The secrets of high luminosity

- You want to squeeze two beams of particles, traveling at the speed of light, down to 50 nm and collide them head on to produce many collisions. Seriously? How does one do this?
- Various ideas have been proposed:
 - Crab cavities
 - Crab waist
 - Nano-beam scheme

Crab Cavities: KEKB

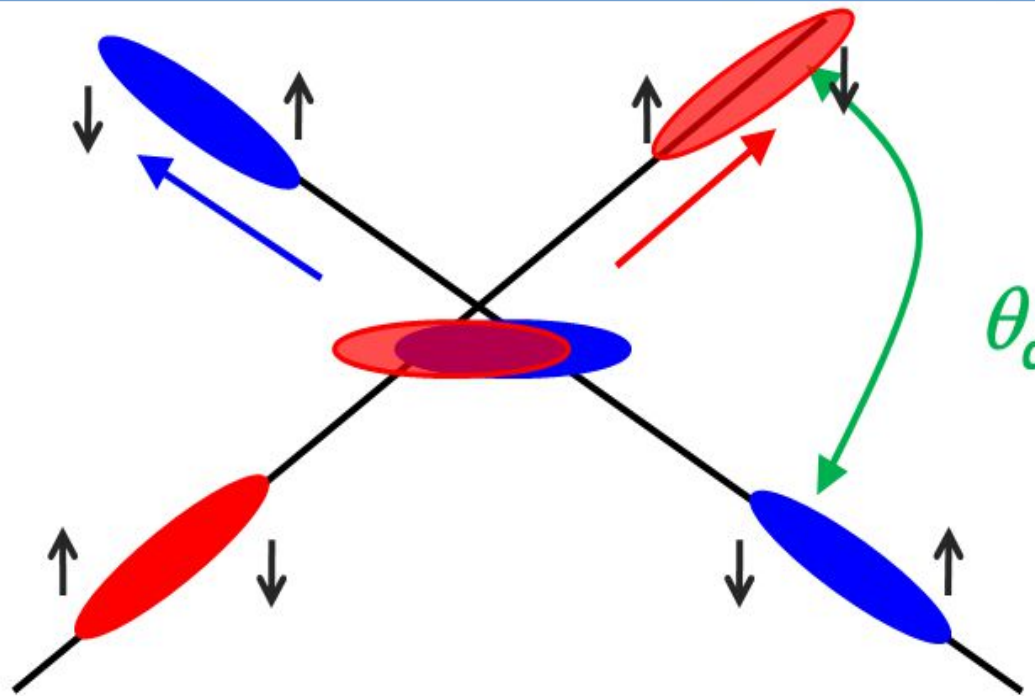

- RF crab cavity deflects head and tail in opposite direction so that collision is effectively “head on” for luminosity and tune shift
- bunch centroids still cross at an angle (easy separation)
- First proposed in 1988, in operation at KEKB since 2007
→ *world record luminosity!*

Crab Cavities & KEKB

Luminosity of KEKB
Oct. 1999 - June 2010

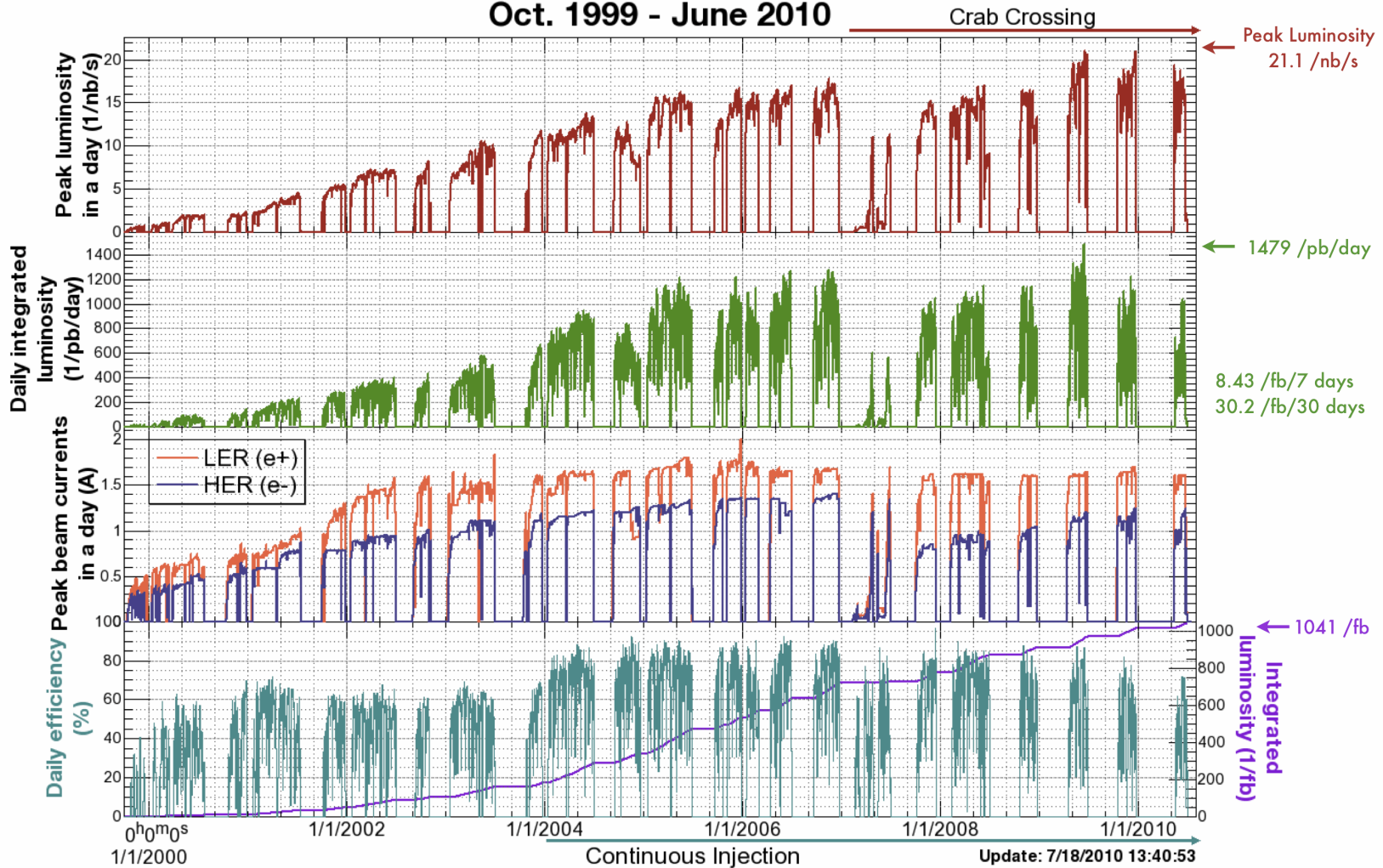

Crab waist & Nanobeam schemes

Crab waist, SuperB:

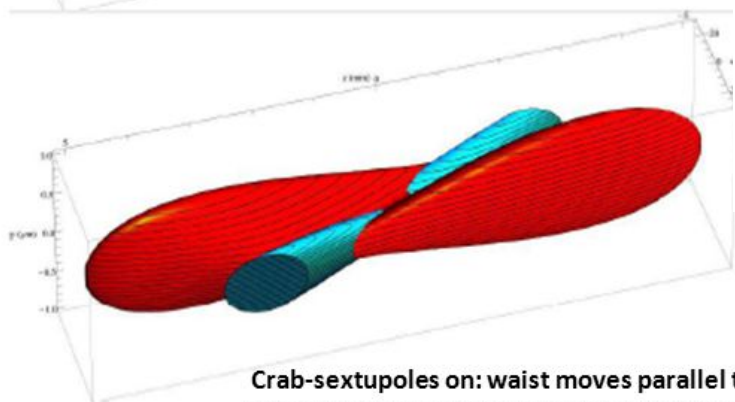
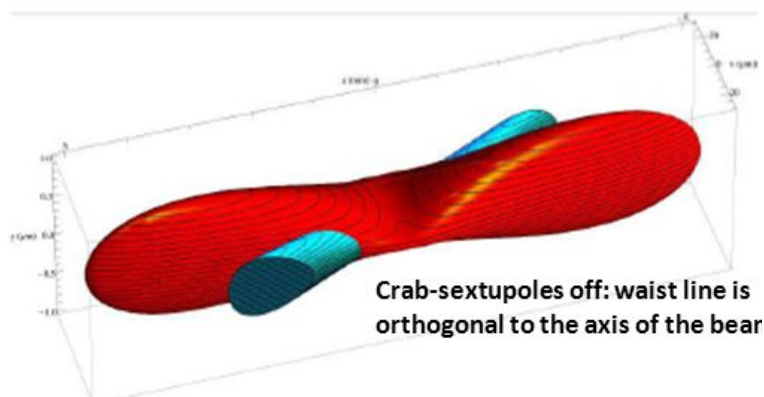

Nanobeam scheme [SuperKEKB]

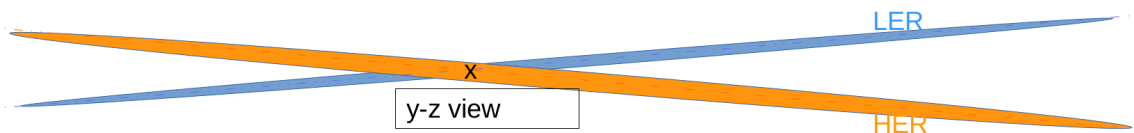
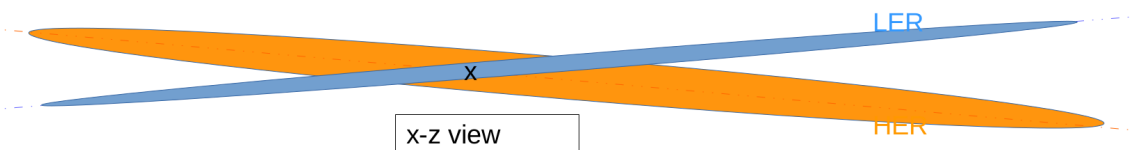

Physics Goals of Belle II

■ Continuing Studies / Precision Physics Topics

★ CPV in B decays, other B decay physics

- ▶ CPV only seen in the meson sector; CPV in B decays is theoretically clean
- ▶ Related: Is there CPV in the charm sector? If so, does it accord with the SM?
- ▶ B / Bottomonium spectroscopy

★ Charm Physics

- ▶ CPV in mixing, direct CPV, ...
- ▶ QCD
- ▶ Semileptonic Decays
- ▶ Charm / Charmonium spectroscopy

★ Tau Physics

- ▶ Confirm $R(D)$ and $R(D^*)$. Consistent with new Higgs / other high mass particles?
- ▶ Do we see rare and forbidden decays such as $\tau \rightarrow \mu\gamma$, $\tau \rightarrow eee$?
- ▶ Do we see CPV in decays such as $\tau \rightarrow K_S^0 \pi \nu$?

■ Beyond the Standard Model / New Physics (BSM / NP)

- ★ An important check: if there are **new Higgses**, do we see evidence for them?
- ★ Are there indications of **new CPV phases**, of **right-handed currents** or other **new weak bosons**? Is there **CPV in charm decays** and can we interpret it correctly?
- ★ Is there further evidence of **LFV and / or FCNC** in new decay modes?
- ★ Do we see new low mass **dark photons** or other **light dark matter particles**?

Vertex Detectors

Beam pipe radius reduced from 2cm-1.5cm for Belle to 1cm for Belle II.

New vertex detectors: 2 layers of pixels (DEPFETs: Depleted P- Channel Field Effect Transistor) and 4 layers of DSSD (Double Sided Silicon strip Detectors).

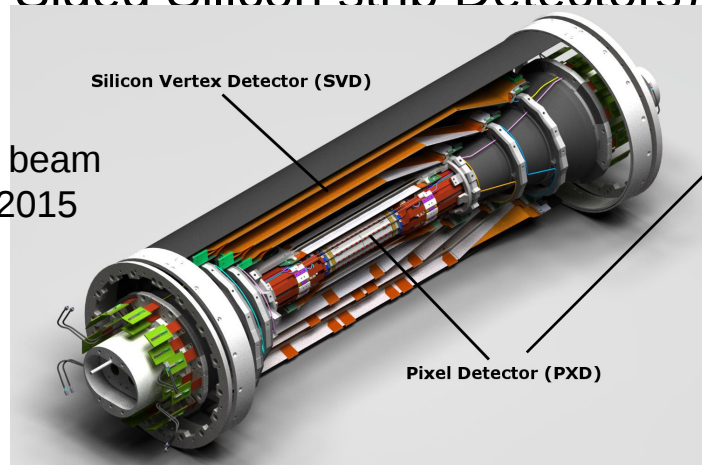

Into test beam
in June 2015

Beam Pipe	r = 10mm
DEPFET	
Layer 1	r = 14mm
Layer 2	r = 22mm
DSSD	
Layer 3	r = 38mm
Layer 4	r = 80mm
Layer 5	r = 115mm
Layer 6	r = 140mm

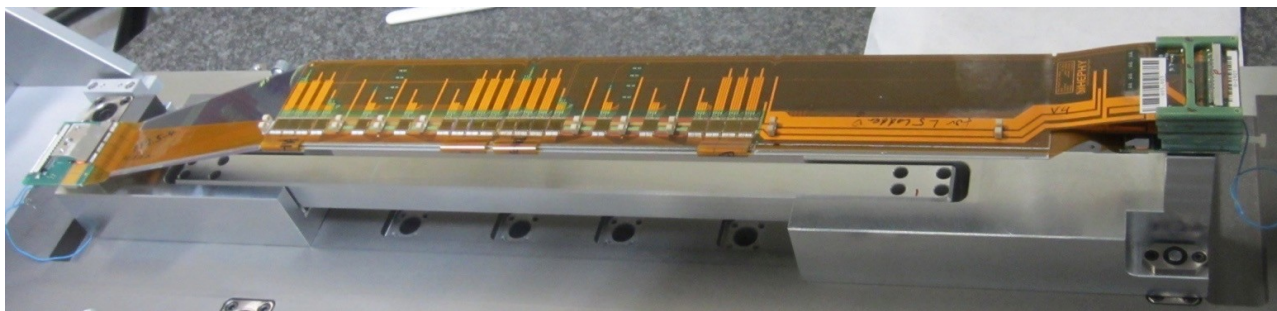

First working
SVD ladder
readout at
Vienna in
April

Central Drift Chamber

- Outer radius of Belle II CDC is 28% bigger than the Belle CDC.
- Stringing of 51456 wires was completed in January 2014.
- Commissioning with cosmic rays is ongoing.

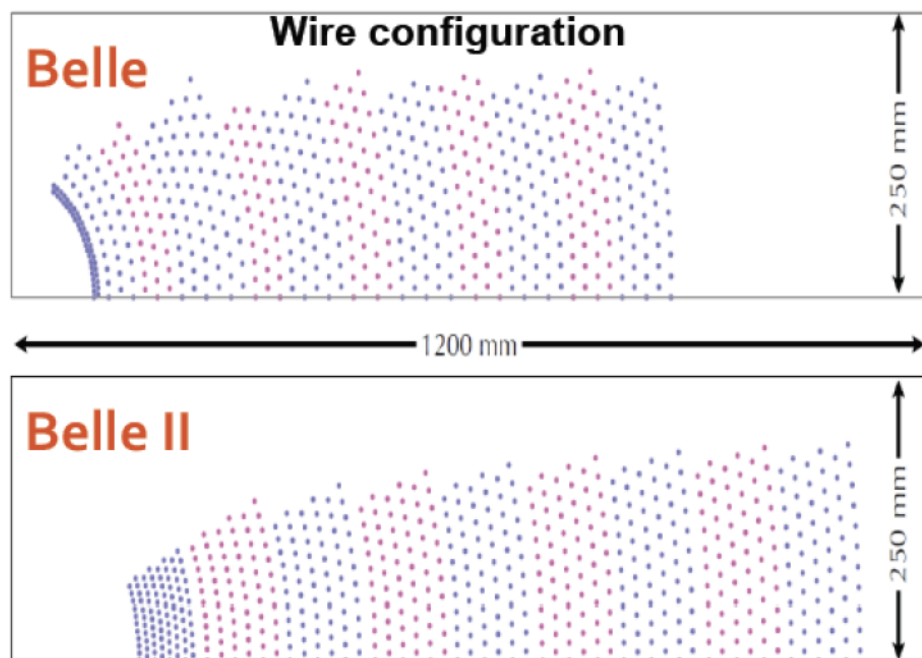

	Belle	Belle II
Innermost sense wire	r=88mm	r=168mm
Outermost sense wire	r=863mm	r=1111.4mm
Number of layers	50	56
Total sense wires	8400	14336
Gas	He:C ₂ H ₆	He:C ₂ H ₆
Sense wire	W(Φ30μm)	W(Φ30μm)
Field wire	Al(Φ120μm)	Al(Φ120μm)

TOP Detector

- The Imaging Time of Propagation (TOP) detector does particle ID from a perch between the CDC and EM calorimeter, a gap of $\sim 10\text{cm}$.
- It operates both as a time-of-flight detector and a ring imaging Cherenkov counter.

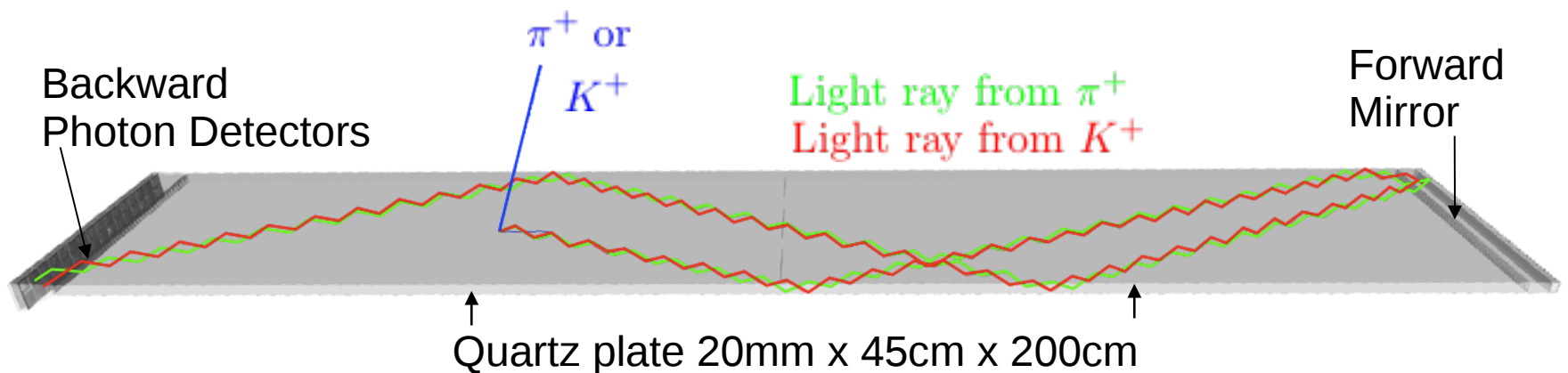

- The light rays never have the opportunity to form a ring image in space only. The “image” is in space-time and thus requires superb time measurement to resolve.
- The point of impact and the angle of the trajectory are determined from CDC data.

Aerogel RICH

- The ARICH does particle ID in the forward endcap.
- In contrast with the TOP it detects Cherenkov light as rings in space only.

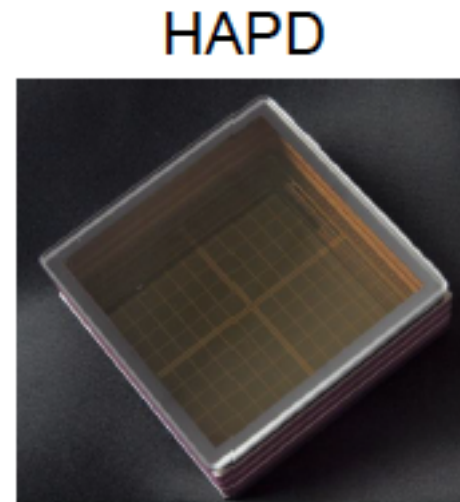
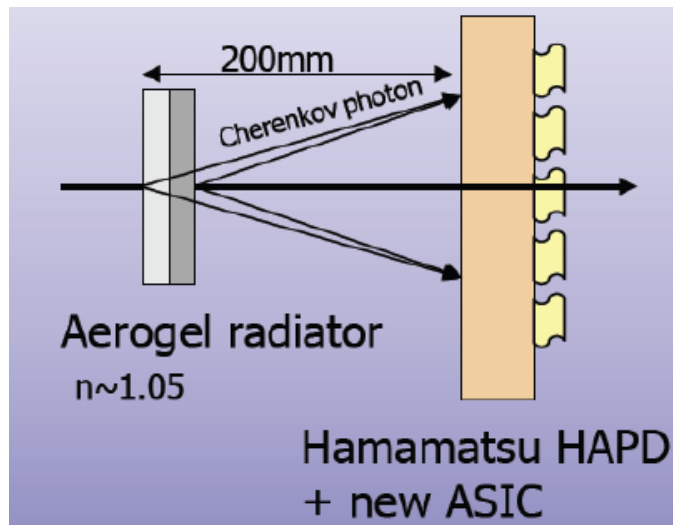

- ARICH incorporates 420 Hybrid Avalanche Photo Detectors (HAPD), each with 144 channels.

P. Urquijo [B2-1]

Belle uncertainties and Belle II projections

Observables		Belle (2014)	Belle II	
			5 ab ⁻¹	50 ab ⁻¹
UT angles	$\sin 2\beta$	$0.667 \pm 0.023 \pm 0.012$ [56]	0.012	0.008
	α [°]	85 ± 4 (Belle+BaBar) [24]	2	1
	γ [°]	68 ± 14 [13]	6	1.5
Gluonic penguins	$S(B \rightarrow \phi K^0)$	$0.90^{+0.09}_{-0.19}$ [19]	0.053	0.018
	$S(B \rightarrow \eta' K^0)$	$0.68 \pm 0.07 \pm 0.03$ [57]	0.028	0.011
	$S(B \rightarrow K_S^0 K_S^0 K_S^0)$	$0.30 \pm 0.32 \pm 0.08$ [17]	0.100	0.033
	$\mathcal{A}(B \rightarrow K^0 \pi^0)$	$-0.05 \pm 0.14 \pm 0.05$ [58]	0.07	0.04
UT sides	$ V_{cb} $ incl.	$41.6 \cdot 10^{-3} (1 \pm 1.8\%)$ [8]	1.2%	
	$ V_{cb} $ excl.	$37.5 \cdot 10^{-3} (1 \pm 3.0\%_{\text{ex.}} \pm 2.7\%_{\text{th.}})$ [10]	1.8%	1.4%
	$ V_{ub} $ incl.	$4.47 \cdot 10^{-3} (1 \pm 6.0\%_{\text{ex.}} \pm 2.5\%_{\text{th.}})$ [5]	3.4%	3.0%
	$ V_{ub} $ excl. (had. tag.)	$3.52 \cdot 10^{-3} (1 \pm 9.5\%)$ [7]	4.4%	2.3%
Missing E decays	$\mathcal{B}(B \rightarrow \tau \nu)$ [10^{-6}]	$96 (1 \pm 27\%)$ [26]	10%	5%
	$\mathcal{B}(B \rightarrow \mu \nu)$ [10^{-6}]	< 1.7 [59]	20%	7%
	$R(B \rightarrow D \tau \nu)$	$0.440 (1 \pm 16.5\%)$ [29] [†]	5.2%	3.4%
	$R(B \rightarrow D^* \tau \nu)$ [†]	$0.332 (1 \pm 9.0\%)$ [29] [†]	2.9%	2.1%
	$\mathcal{B}(B \rightarrow K^{*+} \nu \bar{\nu})$ [10^{-6}]	< 40 [31]	< 15	20%
	$\mathcal{B}(B \rightarrow K^+ \nu \bar{\nu})$ [10^{-6}]	< 55 [31]	< 21	30%
Rad. & EW penguins	$\mathcal{B}(B \rightarrow X_s \gamma)$	$3.45 \cdot 10^{-4} (1 \pm 4.3\% \pm 11.6\%)$	7%	6%
	$A_{CP}(B \rightarrow X_s \gamma)$ [10^{-2}]	$2.2 \pm 4.0 \pm 0.8$ [60]	1	0.5
	$S(B \rightarrow K_S^0 \pi^0 \gamma)$	$-0.10 \pm 0.31 \pm 0.07$ [20]	0.11	0.035
	$S(B \rightarrow \rho \gamma)$	$-0.83 \pm 0.65 \pm 0.18$ [21]	0.23	0.07
	$C_7/C_9 (B \rightarrow X_s \ell \ell)$	$\sim 20\%$ [37]	10%	5%
	$\mathcal{B}(B_s \rightarrow \gamma \gamma)$ [10^{-6}]	< 8.7 [40]	0.3	–
	$\mathcal{B}(B_s \rightarrow \tau \tau)$ [10^{-3}]	–	< 2 [42] [‡]	–
	Charm Rare	$\mathcal{B}(D_s \rightarrow \mu \nu)$	$5.31 \cdot 10^{-3} (1 \pm 5.3\% \pm 3.8\%)$ [44]	2.9%
$\mathcal{B}(D_s \rightarrow \tau \nu)$		$5.70 \cdot 10^{-3} (1 \pm 3.7\% \pm 5.4\%)$ [44]	3.5%	3.6%
$\mathcal{B}(D^0 \rightarrow \gamma \gamma)$ [10^{-6}]		< 1.5 [47]	30%	25%
Charm CP	$A_{CP}(D^0 \rightarrow K^+ K^-)$ [10^{-2}]	$-0.32 \pm 0.21 \pm 0.09$ [61]	0.11	0.06
	$A_{CP}(D^0 \rightarrow \pi^0 \pi^0)$ [10^{-2}]	$-0.03 \pm 0.64 \pm 0.10$ [62]	0.29	0.09
	$A_{CP}(D^0 \rightarrow K_S^0 \pi^0)$ [10^{-2}]	$-0.21 \pm 0.16 \pm 0.09$ [62]	0.08	0.03
Charm Mixing	$x(D^0 \rightarrow K_S^0 \pi^+ \pi^-)$ [10^{-2}]	$0.56 \pm 0.19 \pm 0.07$ [50]	0.14	0.11
	$y(D^0 \rightarrow K_S^0 \pi^+ \pi^-)$ [10^{-2}]	$0.30 \pm 0.15 \pm 0.05$ [50]	0.08	0.05
	$ q/p (D^0 \rightarrow K_S^0 \pi^+ \pi^-)$	$0.90 \pm 0.16 \pm 0.08$ [50]	0.10	0.07
	$\phi(D^0 \rightarrow K_S^0 \pi^+ \pi^-)$ [°]	$-6 \pm 11 \pm 4$ [50]	6	4
Tau	$\tau \rightarrow \mu \gamma$ [10^{-9}]	< 45 [63]	< 14.7	< 4.7
	$\tau \rightarrow e \gamma$ [10^{-9}]	< 120 [63]	< 39	< 12
	$\tau \rightarrow \mu \mu \mu$ [10^{-9}]	< 21.0 [64]	< 3.0	< 0.3

B \rightarrow D^(*) τ ν Belle Results

Tag side

- inclusive
- hadronic
- semileptonic

Signal side

- $\tau \rightarrow l \nu \nu$
- $\tau \rightarrow \pi \nu \nu$

$$R(D^{(*)}) \equiv \frac{BF(B \rightarrow D^{(*)} \tau^- \bar{\nu}_\tau)}{BF(B \rightarrow D^{(*)} l^- \bar{\nu}_l)}$$

$$(l^- = e^-, \mu^-)$$

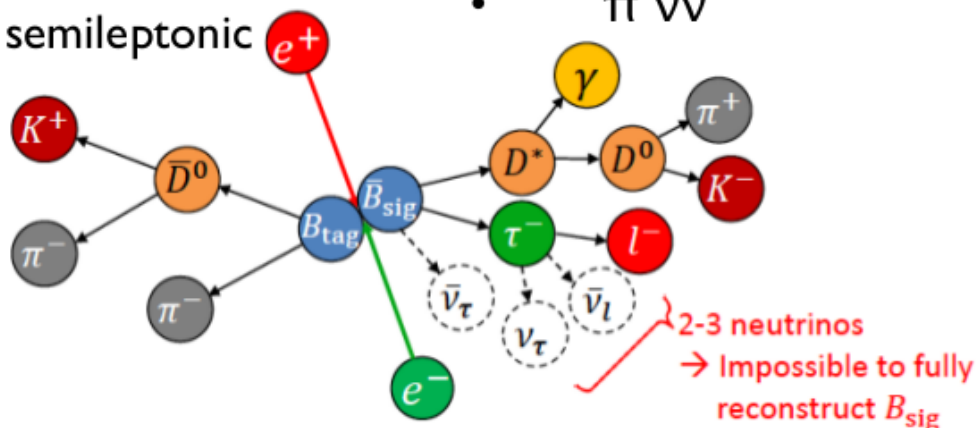

year	tag	τ mode	R(D)	R(D [*])	Ref.
2007	incl.	$\pi \nu, l \nu \nu$	0.38 ± 0.11	0.34 ± 0.08	PRL99, 191807 (2007)
2010	incl.	$\pi \nu, l \nu \nu$			PRD82, 072005 (2010)
2015	had.	$l \nu \nu$	$0.375 \pm 0.064 \pm 0.026$	$0.293 \pm 0.038 \pm 0.015$	PRD92, 072014 (2015)
2016	s.l.	$l \nu \nu$	IN PROGRESS	$0.302 \pm 0.030 \pm 0.011$	PRD94, 072007 (2016)
2017	had.	$\pi \nu, \rho \nu$		$0.270 \pm 0.035 \pm 0.027$	PRL118, 211801 (2017), PRD97, 012004 (2018)

$\sim 20\%$ (stat) $\sim 7\%$ (syst)

$\sim 10-13\%$ (stat) $\sim 3.6-10\%$ (syst)

$B \rightarrow D^{(*)} \tau \nu$ w/ $\tau \rightarrow l \nu \nu$ & had. tag

PRD92,072014 (2015)

- M_{miss}^2 to measure $B \rightarrow D^{(*)} l \nu$
 - $M_{\text{miss}}^2 = [p(e^+e^-) - p(B_{\text{tag}}) - p(D^{(*)}) - p(l)]^2$
- Transformed neural network output (O'_{NB}) to measure $B \rightarrow D^{(*)} \tau \nu$
 - Powerful input: sum of ECL energy not used for signal reconstruction (E_{ECL})

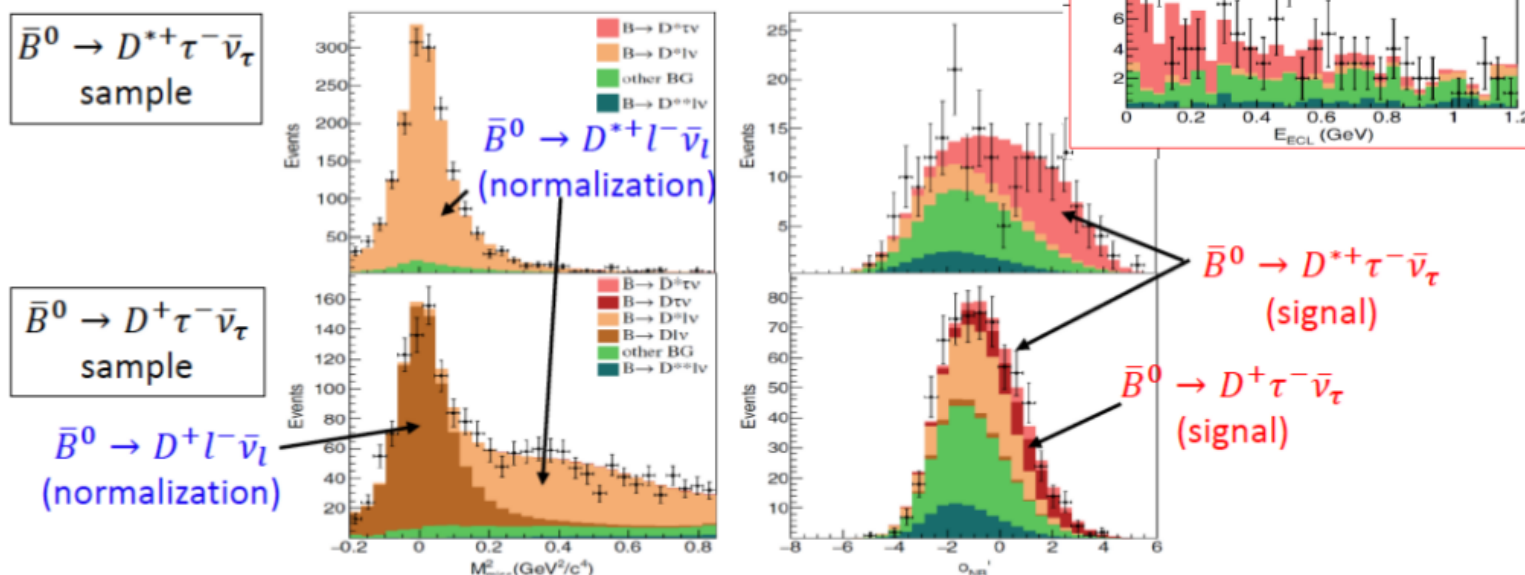

$$R(D) = 0.375 \pm 0.064(\text{stat.}) \pm 0.026(\text{syst.})$$

$$R(D^*) = 0.293 \pm 0.038(\text{stat.}) \pm 0.015(\text{syst.})$$

$B \rightarrow D^* \tau \nu$ w/ $\tau \rightarrow l \nu \nu$ & s.l. tag

PRD94, 072007 (2016)

- More background due to additional ν
- Signal/normalization modes are separated by $\cos\theta_{B-D^*l}$
- Two dimensional fit to neural network output (O_{NB}) and E_{ECL}
- The first measurement of $B \rightarrow D^* l \nu$ with s.l. tagging technique

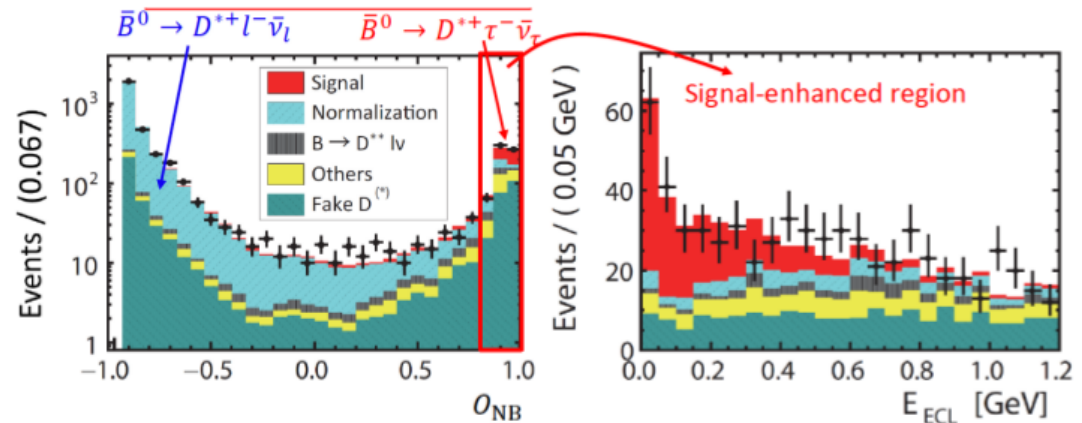
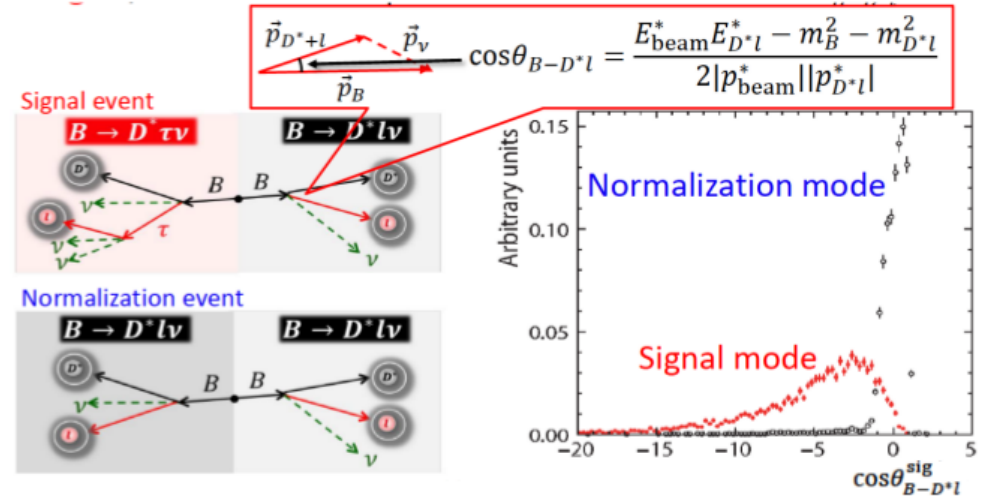

$$R(D^*) = 0.302 \pm 0.030 \text{ (stat.)} \pm 0.011 \text{ (syst.)}$$

$B \rightarrow D^* \tau \nu$ w/ $\tau \rightarrow \pi/\rho \nu$ & had. tag

PRL 118, 211801 (2017), PRD97, 012004 (2018)

Analysis w/ τ hadronic decays

→ τ polarization

$$P_\tau(D^*) = -0.497 \pm 0.013$$

$$\frac{1}{\Gamma(D^{(*)})} \frac{d\Gamma(D^{(*)})}{d\cos\theta_{\text{hel}}} = \frac{1}{2} \left[1 + \alpha P_\tau(D^{(*)}) \cos\theta_{\text{hel}} \right]$$

$\tau \rightarrow \pi\nu: \alpha=1.0, \tau \rightarrow \rho\nu: \alpha=0.449$

$$P_\tau(D^*) = \frac{2 N_{\text{sig}}(\cos\theta_{\text{hel}} > 0) - N_{\text{sig}}(\cos\theta_{\text{hel}} < 0)}{\alpha N_{\text{sig}}(\cos\theta_{\text{hel}} > 0) + N_{\text{sig}}(\cos\theta_{\text{hel}} < 0)}$$

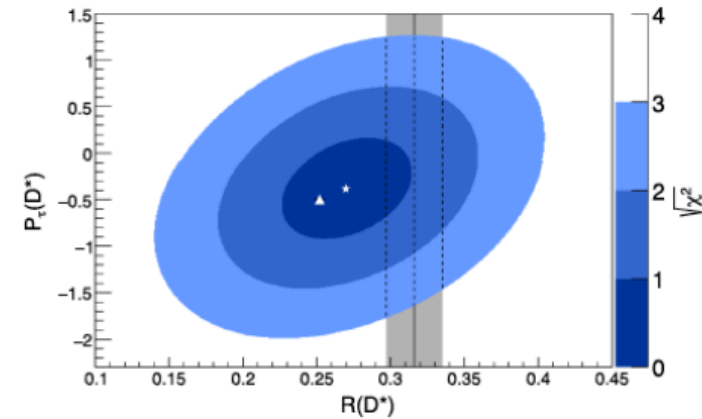
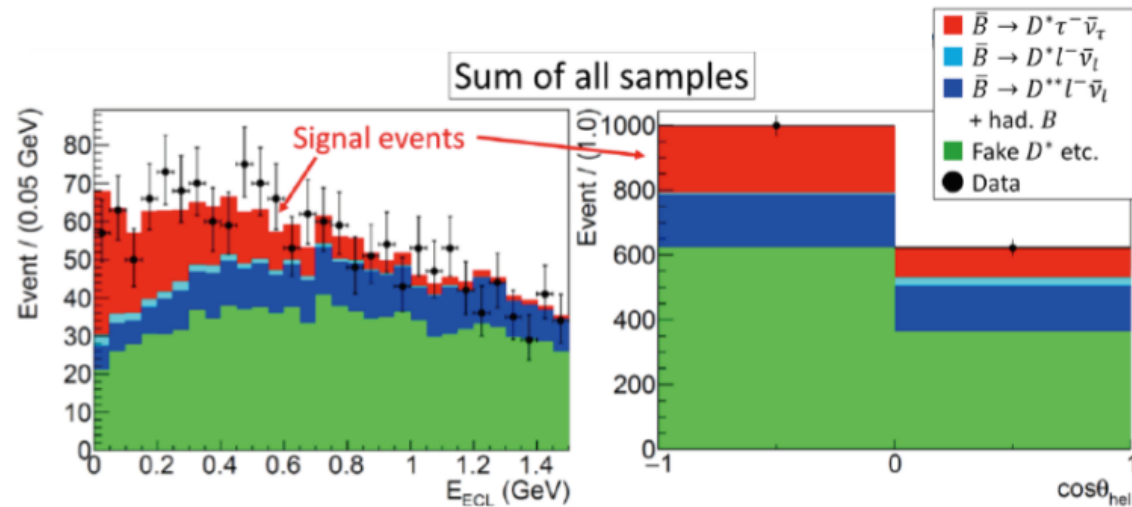
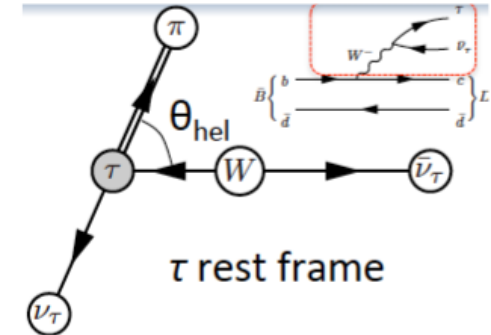

$$R(D^*) = 0.270 \pm 0.035(\text{stat.}) \begin{matrix} +0.028 \\ -0.025 \end{matrix}(\text{syst.})$$

$$P_\tau(D^*) = -0.38 \pm 0.51(\text{stat.}) \begin{matrix} +0.21 \\ -0.16 \end{matrix}(\text{syst.})$$

The first measurement of $P_\tau(D^*) : < +0.5$ (90% C.L.)

Measurement of τ polarization

$$\frac{1}{\Gamma} \frac{d\Gamma}{d\cos\theta_{\text{hel}}} = \frac{1}{2} (1 + \alpha P_{\tau}(D^*) \cos\theta_{\text{hel}})$$

$$\alpha = \begin{cases} 1 & \text{for } \tau^- \rightarrow \pi^- \nu_{\tau} \\ \sim 0.45 & \text{for } \tau^- \rightarrow \rho^- \nu_{\tau} \end{cases}$$

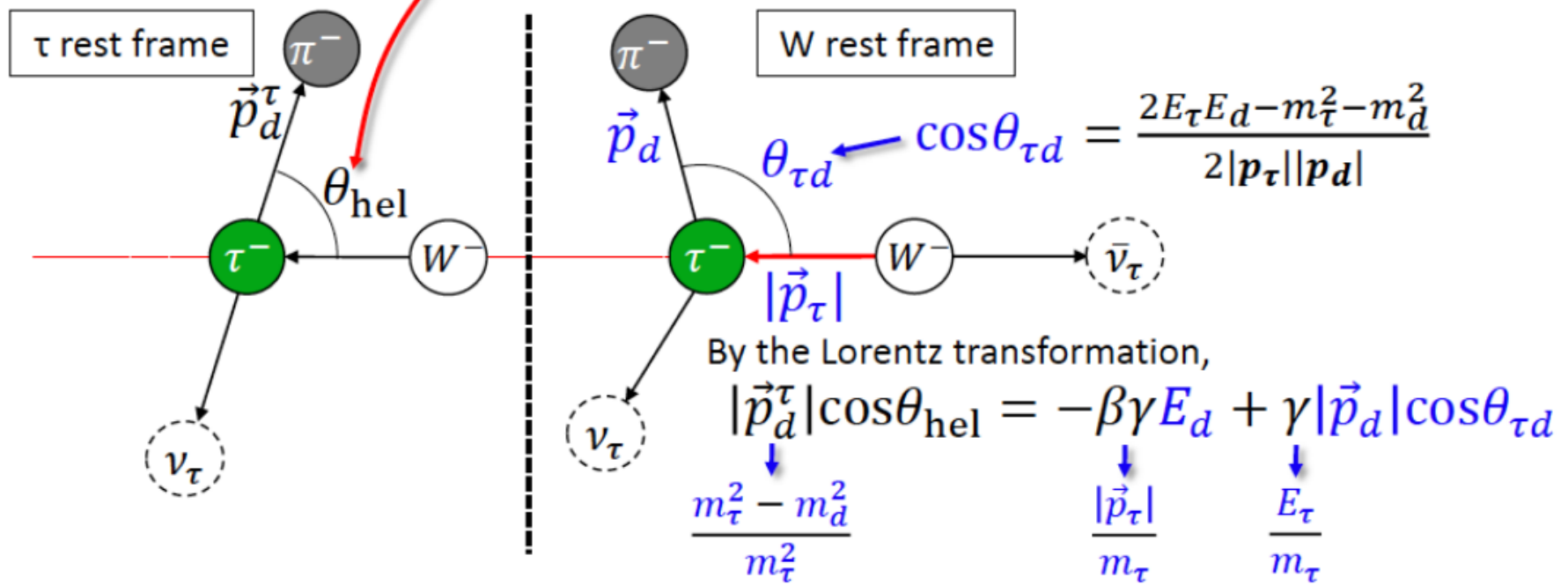

Solving the equation, $\cos\theta_{\text{hel}}$ is obtained!