

Charmonium and Bottomonium Spectroscopy at Belle II

02.09.2019 | Elisabetta Prencipe on behalf of the Belle II Collaboration

International Workshop on Partial
Wave Analyses and Advanced
Tools for Hadron Spectroscopy
PWA11/ATHOS6, Rio de Janeiro



Outline



- Introduction
- Motivation
 - how can we improve the B-factories achievements?
 - open questions
 - new and unique opportunities at Belle II
- The Belle II experiment
- Perspectives in search for exotics at Belle II
 - Charmonium
 - Bottomonium
 - “re-discovery” channels with Phase 3 data
- Summary

Introduction

- Gell-Mann Zweig idea: **Constituent Quark Model**

Still valid for half century → it classifies all known hadrons

- **QCD-motivated models** predict the existence of hadrons with more complex structures than simple qq (mesons) or qqq (baryons) → the so-called XYZ “*charmonium*”-like states

- **Lot of experimental effort to prove the existence of XYZ!**

- No unambiguous evidence for hadrons with *non-CQM-like* structures has been found

- New possibilities, started with the observation of the X(3872):

- tetraquarks - molecular states - pentaquarks - glueballs
- hybrids - hadrocharmonium - hexaquarks - cusps...

- Evidence that there is more than *mesons* and *baryons*!

Substantial contribution from B-factories (1999-2010) into the field

Quark Bound States



Lifetime:
 $< 10^{-8}$ s

Meson



Lifetime:
 $> 10^{30}$ y (proton)
 ~ 10 min (neutron)
 $< 10^{-10}$ s (others)

Baryon

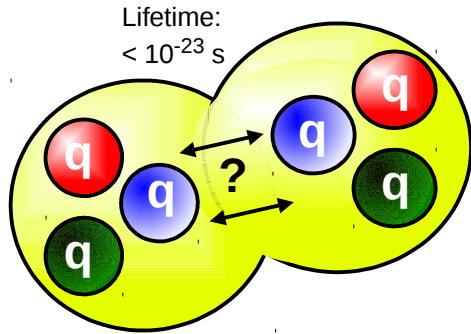

Lifetime:
 $< 10^{-23}$ s

Di-baryon

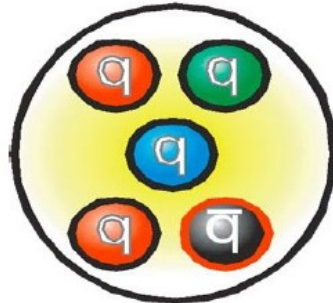

Lifetime:
 $< 10^{-20}$ s

Pentaquark



Hybrid meson



Glueball



Lifetime:
 $< 10^{-23}$ s

Tetraquark



diquark-diantiquark

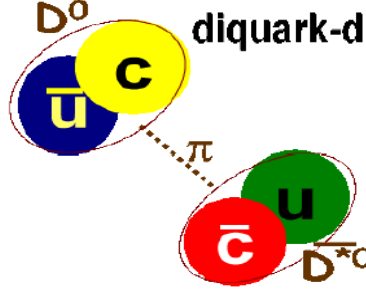

$D^0 - \bar{D}^{*0}$ "molecule"

...and superposition of different states: $c_1 |\bar{q}q\rangle + c_2 |\bar{q}q\bar{q}q\rangle + \dots$

-Onia (conventional and exotics)

- States described by potential models, NRQCD, ..., before B-factories era

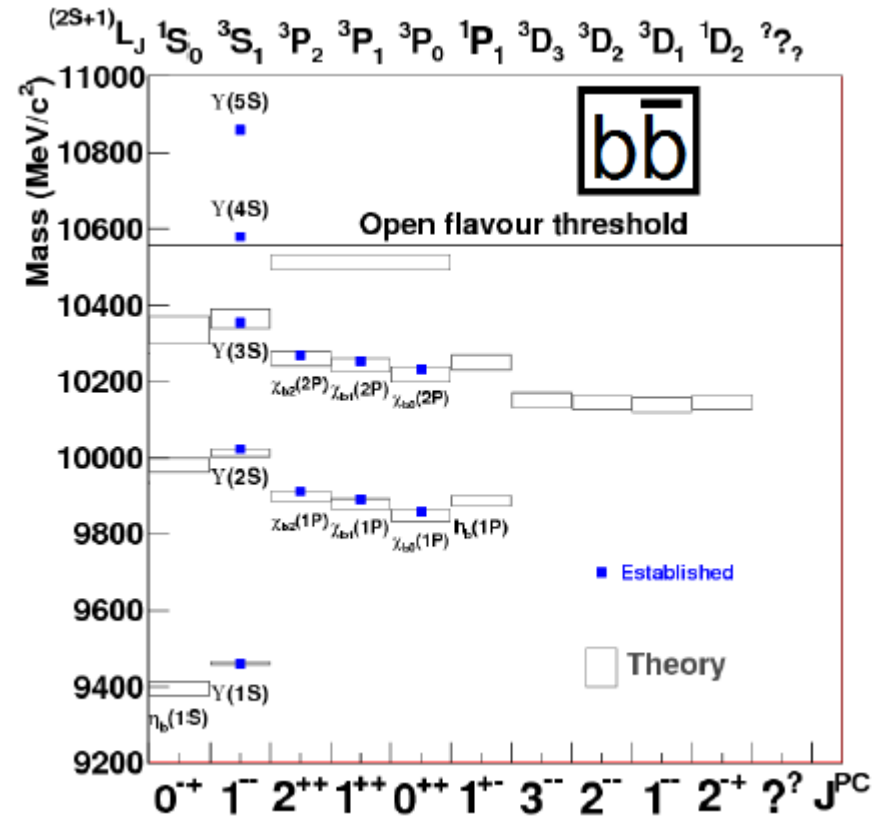
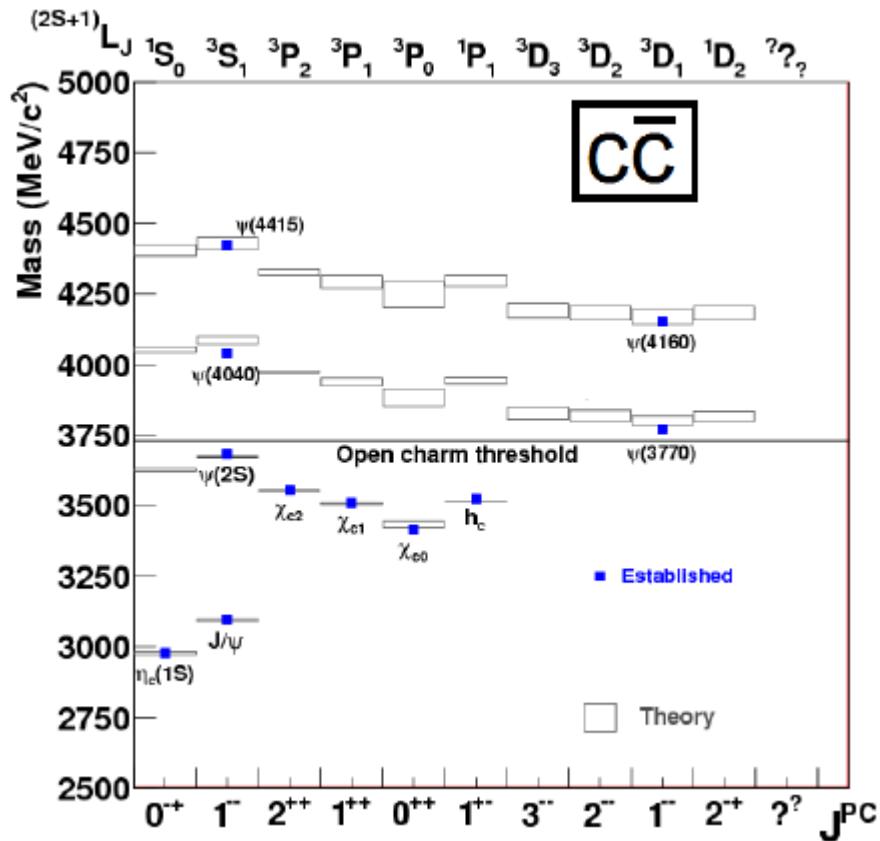

-Onia (conventional and exotics)

- States described by potential models, NRQCD, ..., after B-factories era

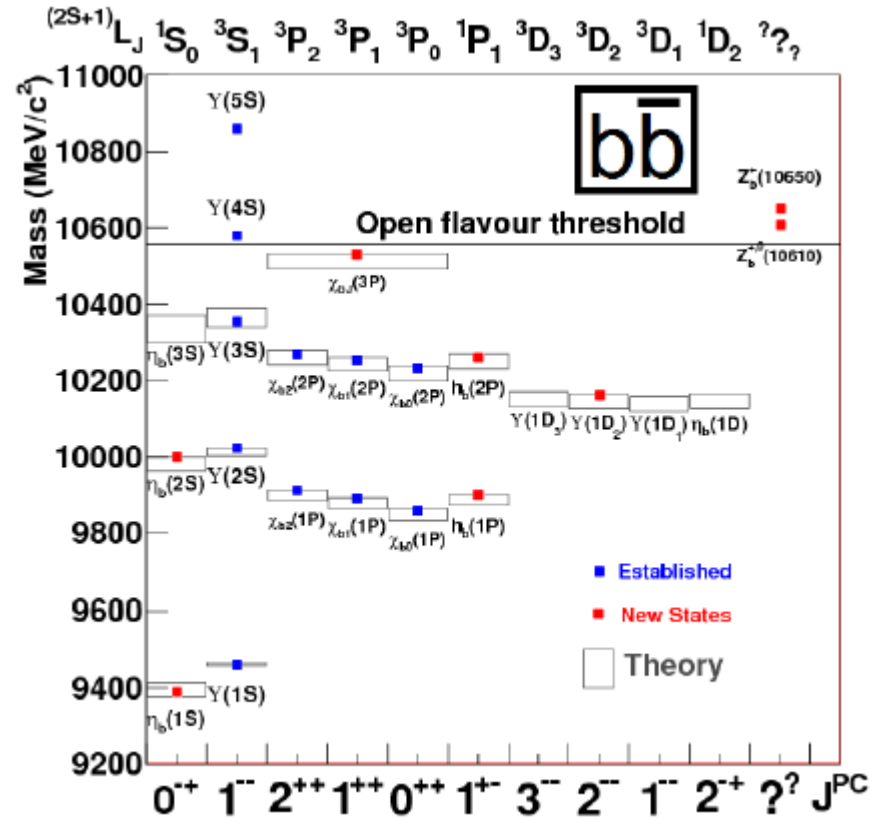
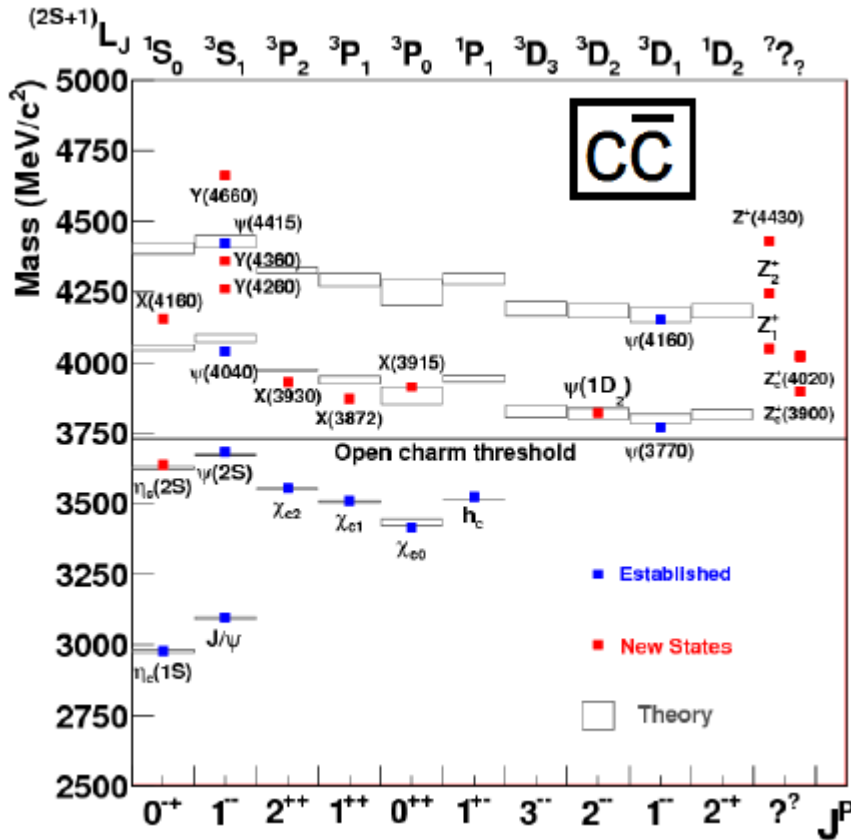

-Onia (conventional and exotics)

- States described by potential models, NRQCD, ..., after B-factories era

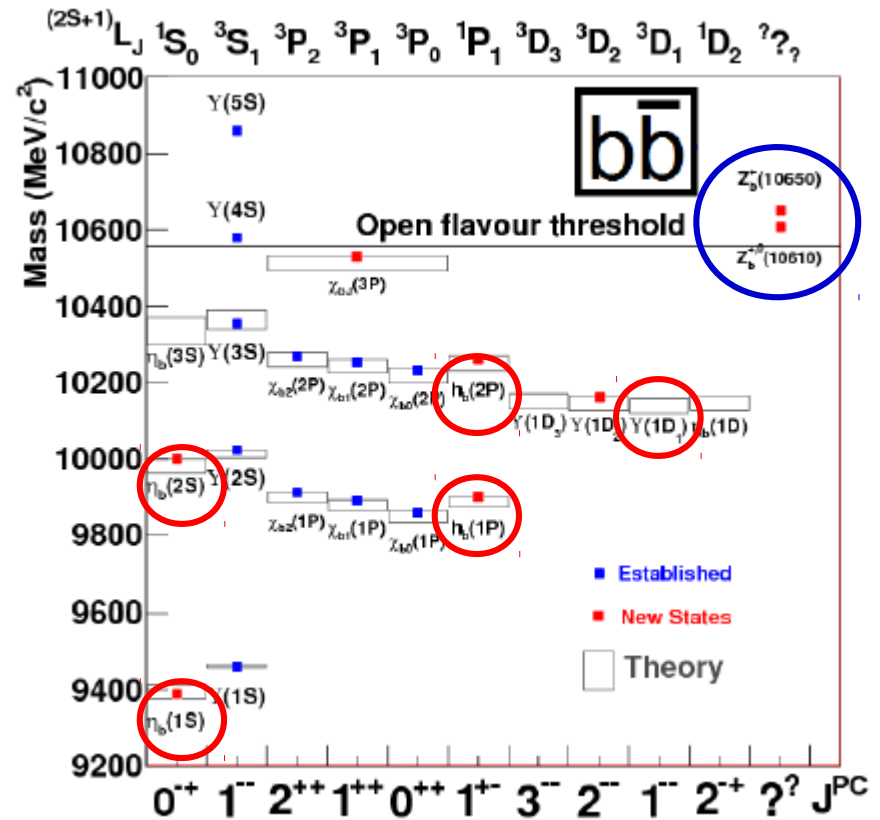
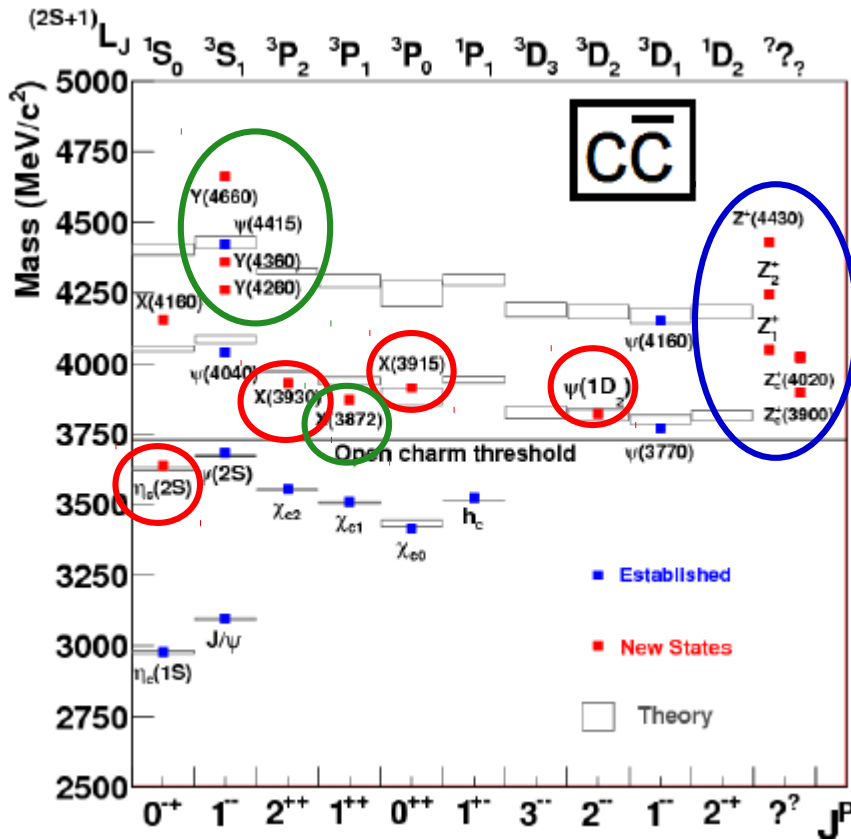

Nomenclature

X, such as the X(3872)

- consistent with $D^0\bar{D}^{*0}$ molecular state
- found in B decays, large production also in pp
- no partners found

Y, such as the Y(4260), Y(4330), Y(4660)

- produced in initial state radiation and $E_{c.m.}$ scan
- $J^{PC} = 1^{--}$
- overpopulated for charmonium

Z, such as the $Z_c(3900)$ and the $Z_b(10610)$

- seen in decays of $q\bar{q}$ and B decays
- charged states: cannot be charmonia
- b- and c- *onia*: similarities

Belle, PRL 91 (2003) 262001

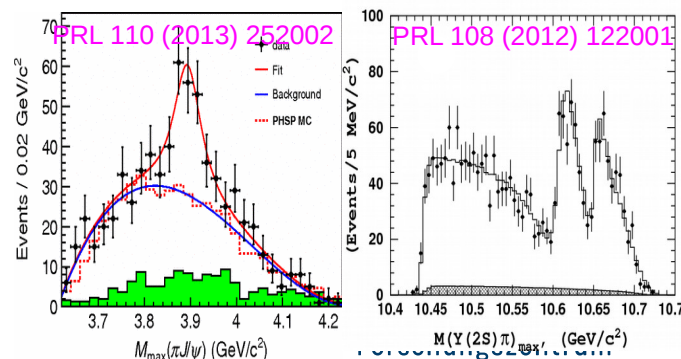
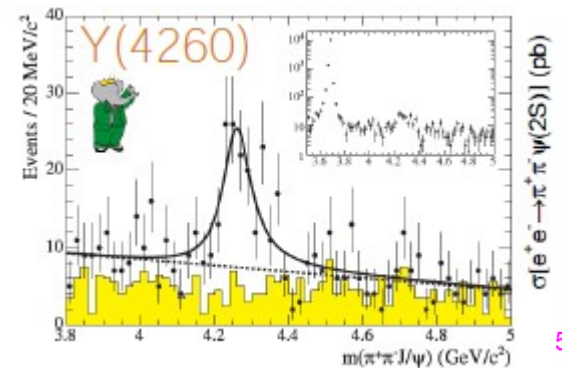
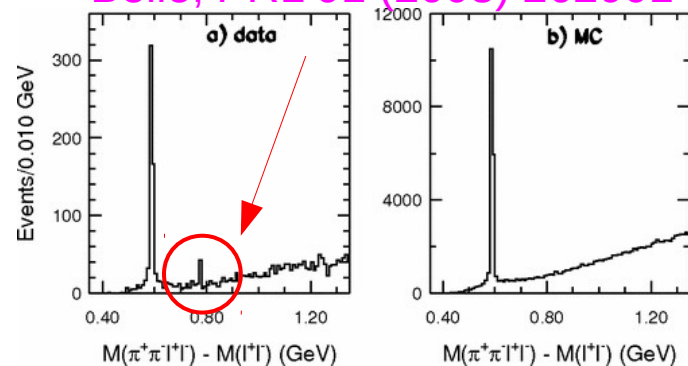

Nomenclature

X, such as the X(3872)

- consistent with $D^0\bar{D}^{*0}$ molecular state
- found in B decays, large production also in pp
- no partners found

Y, such as the Y(4260), Y(4330), Y(4660)

- produced in initial state radiation and $E_{c.m.}$ scan
- $J^{PC} = 1^{--}$
- overpopulated for charmonium

Z, such as the $Z_c(3900)$ and the $Z_b(10610)$

- seen in decays of $q\bar{q}$ and B decays
- charged states: cannot be charmonia
- b- and c- *onia*: similarities

Belle, PRL 91 (2003) 262001

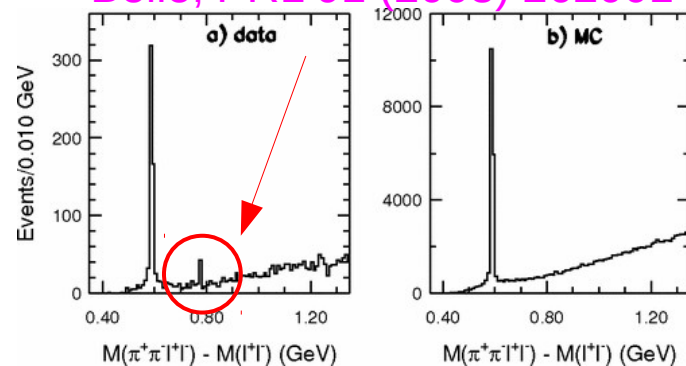

Belle, PRL 99 (2007) 142002

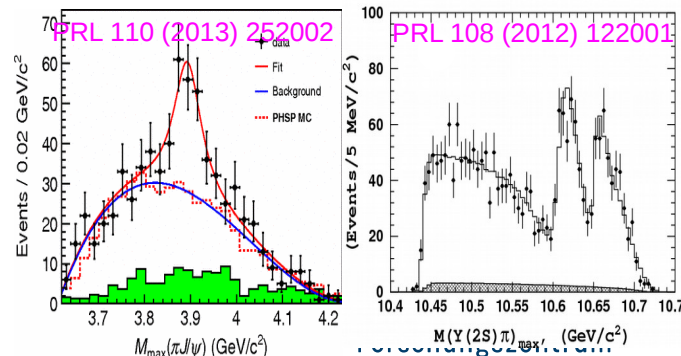
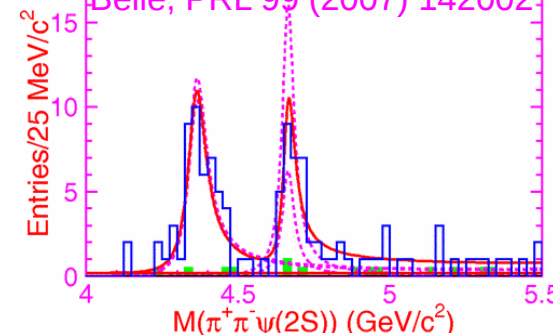

Two different classes of Z states?

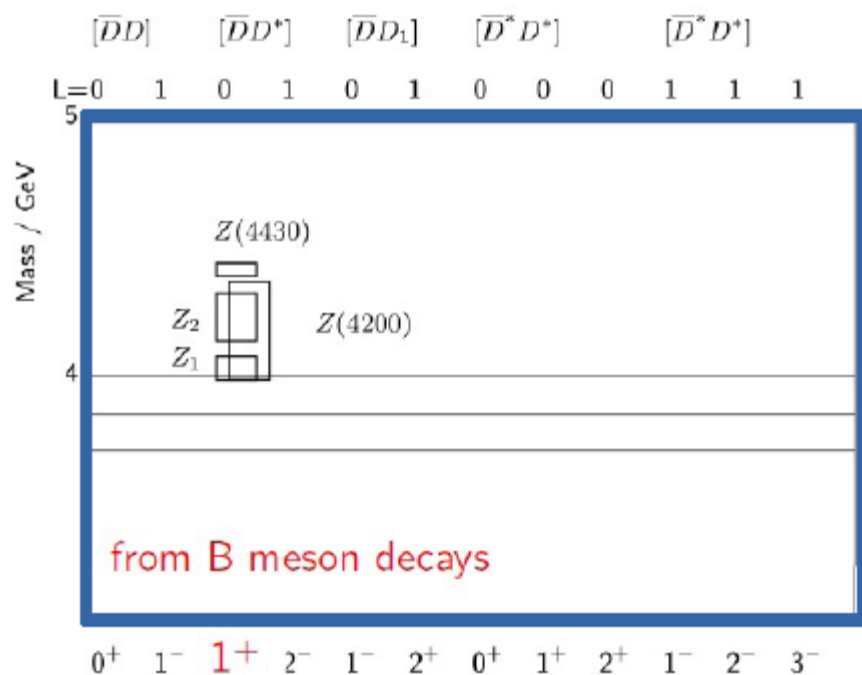

- large widths
- not connected to thresholds?

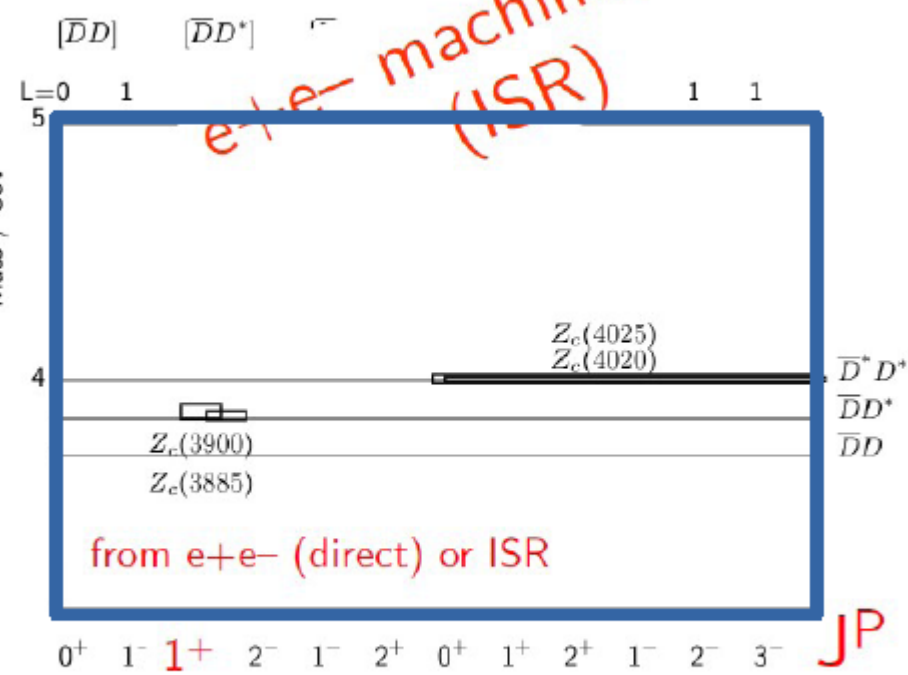

- narrow widths
- near thresholds

- Belle II is in a **unique** position to look for both Z types:
 - through B decays (LHCb, no BES III)
 - threshold state (BES III, no LHCb)

- BaBar + Belle:
 >1.5 ab^{-1} integrated luminosity - triumph in the history of B-factories!

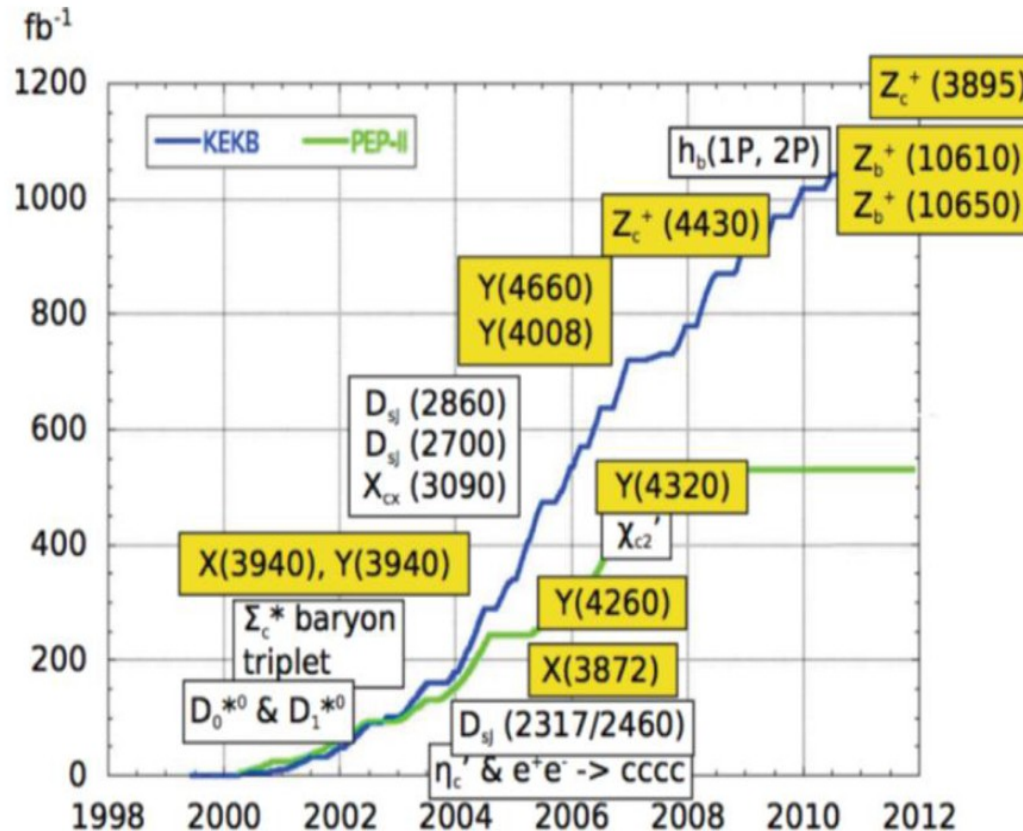

> 1 ab^{-1}
On resonance:
 $Y(5S)$: 121 fb^{-1}
 $Y(4S)$: 711 fb^{-1}
 $Y(3S)$: 3 fb^{-1}
 $Y(2S)$: 25 fb^{-1}
 $Y(1S)$: 6 fb^{-1}
Off reson./scan:
 $\sim 100 \text{ fb}^{-1}$

513.7 $\pm 1.8 \text{ fb}^{-1}$
On resonance:
 $Y(4S)$: 424 fb^{-1} , 471 M
 $Y(3S)$: 28 fb^{-1} , 122 M
 $Y(2S)$: 14 fb^{-1} , 99 M
Off resonance:
 48 fb^{-1}

- Not only B-factory, but $c\bar{c}$ -factory with so high luminosity
- Still statistics limitation in spectroscopy for rare processes ($BR < 10^{-5}$)
- Upgrade needed!

← Belle detector

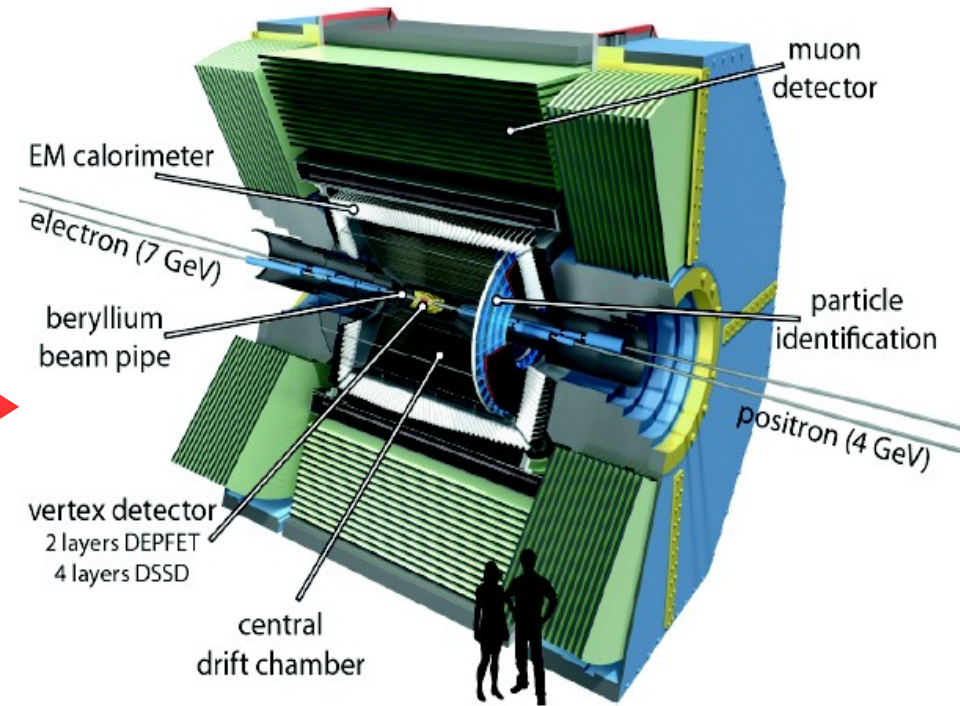
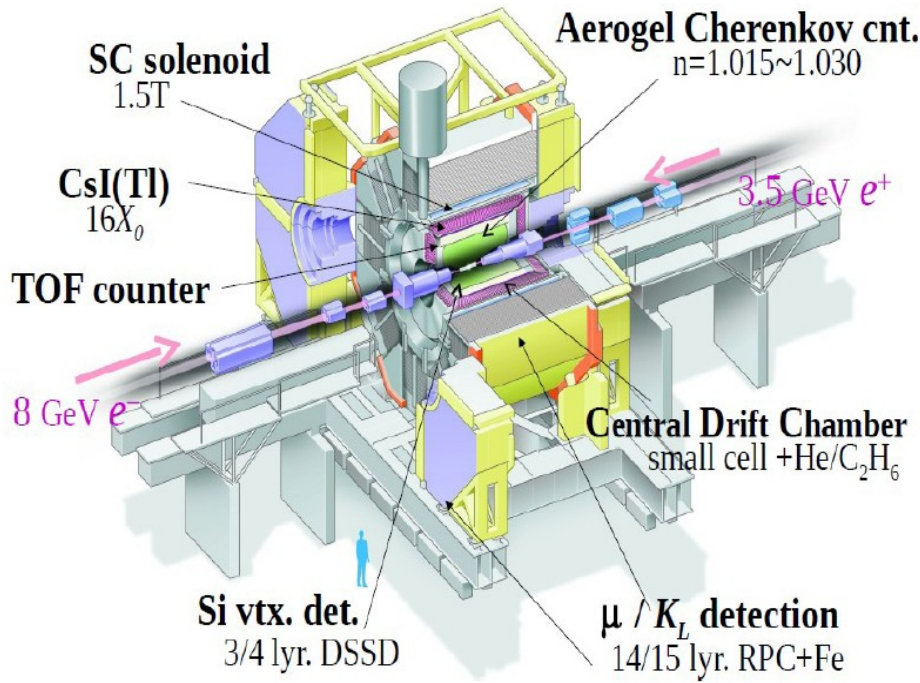

Belle II detector →
26 countries,
952 physicists

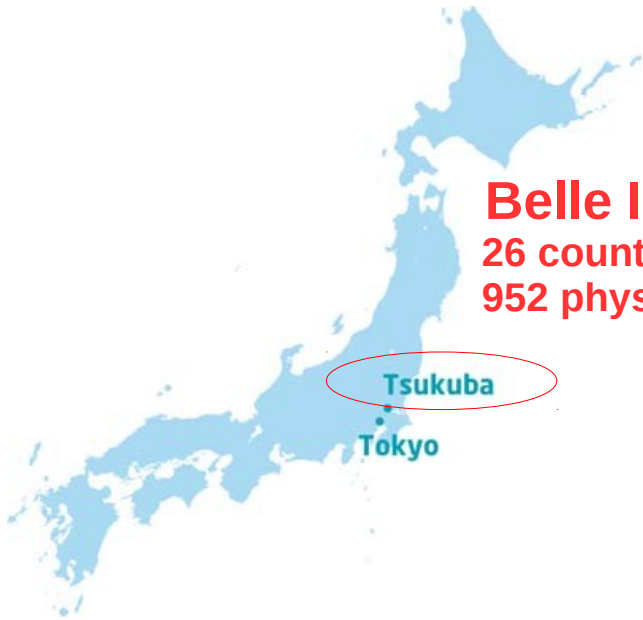

From Belle to Belle II

What has been changed?

- **PXD**, **vertex resolution** in z direction (beam direction) will be factor 2 better than before:
50 μm (Belle) \rightarrow 25 μm (Belle II)
- **TOP**: no TOF (time-of-flight) detector anymore, but TOP (time-of-propagation) will do the timing of the Cerenkov light. Time resolution \sim 50 ps. TOP detector surface is polished to nanometer precision for total reflection of Cerenkov light
- **KLM**: inner 2 layers of barrel + all layers in the endcap replaced by scintillators, because of large background
- **ECL** readout electronics exchanged, fast **FADC** sampling for identify pile-up of pulses
- Huge gain in **luminosity** in Belle II compared to Belle: factor **x40**. How?
 - factor 2 by beam current: 1.64/1.19 A (Belle) \rightarrow 3.6/2.6 A for $e^+(e^-)$ beam in Belle II
 - factor 20 by "**nano-beam**" principle (collision point in vertical direction will be only 59 nm)

β_y^* function: 5.9 mm (Belle), 0.27 mm (Belle II)

$$\beta_y(z) = \beta_y^* \left(1 + \frac{(z - Z_0)^2}{\beta_y^{*2}} \right)$$

$$\sigma_y(z) \propto \sqrt{\beta_y(z)}$$

Luminosity and long term perspectives



- Phase 2, concluded on 17.07.2018: $L = 504.9 \text{ pb}^{-1}$
- Phase 3, concluded on 01.07.2019: $L = 6.5 \text{ fb}^{-1}$
1
- Summer 2020, expected up to 200 fb^{-1}
- By 2026, expected up to 50 ab^{-1}

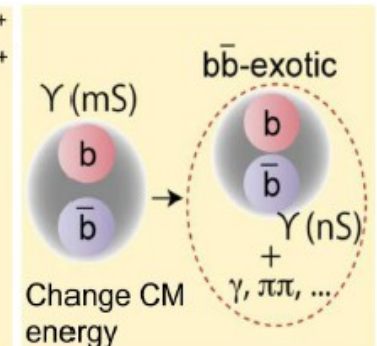
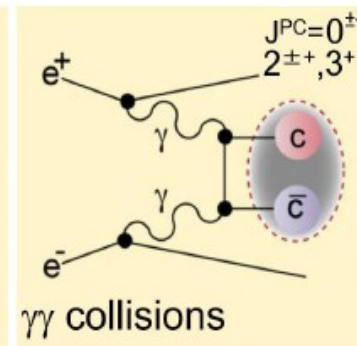
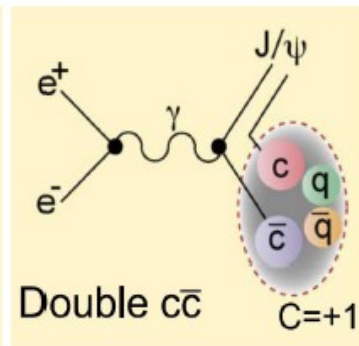
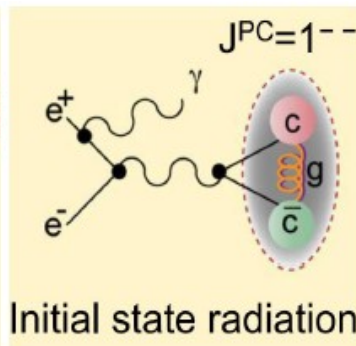
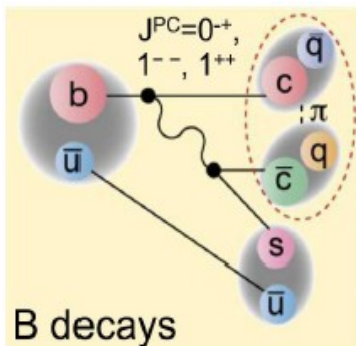
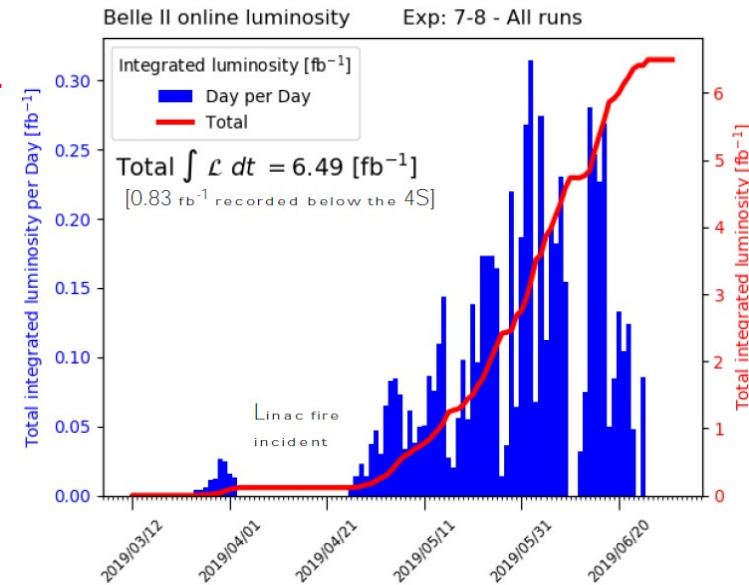

Belle II is performing well!



CDC-dE/dx distribution and predictions

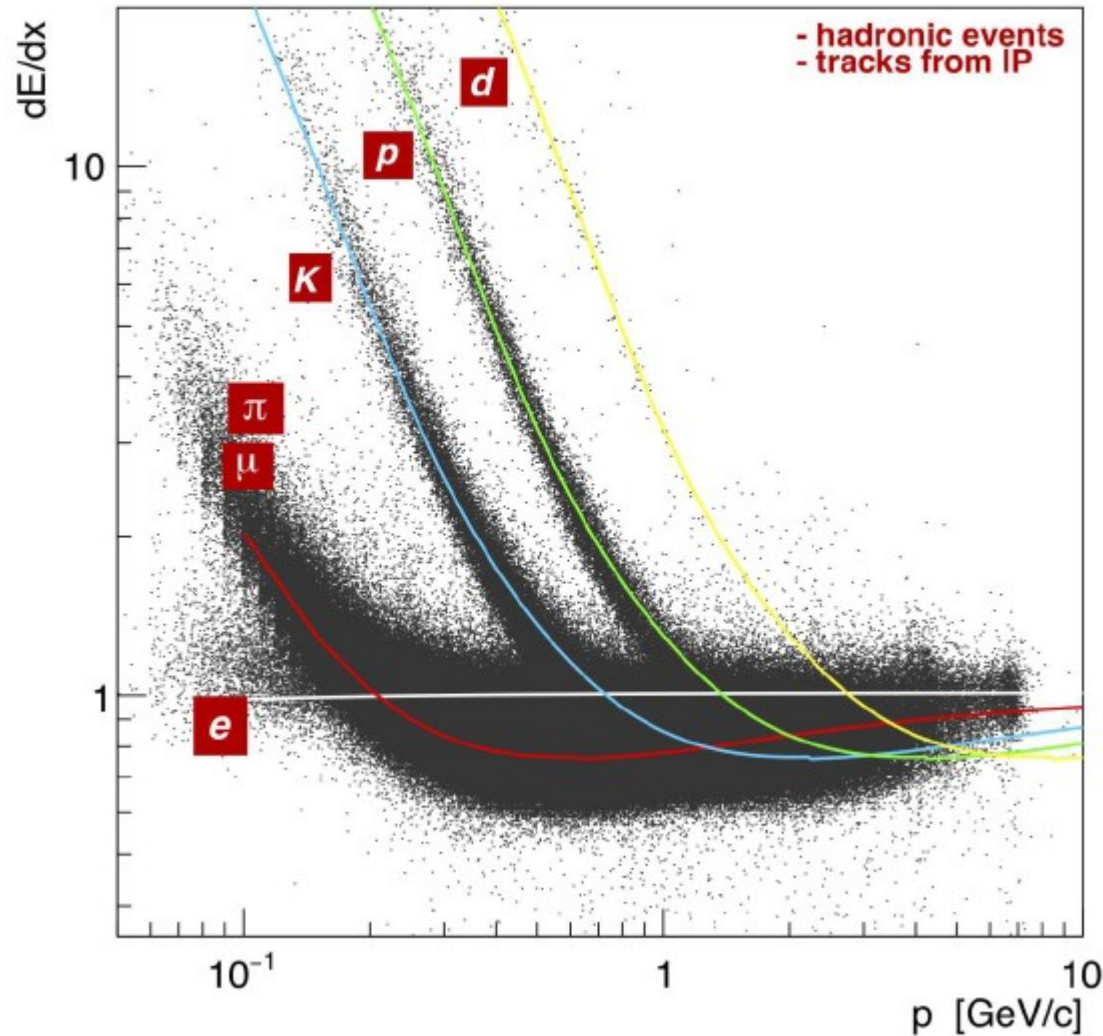

X(3872) total width

Belle, PRD 84 (2011) 052004

- Known upper limit: $\Gamma < 1.2$ MeV (estimated from $X(3872) \rightarrow J/\psi\pi^+\pi^-$), on full Belle data sample
- Very promising: $X(3872) \rightarrow D^0\bar{D}^{0*}$

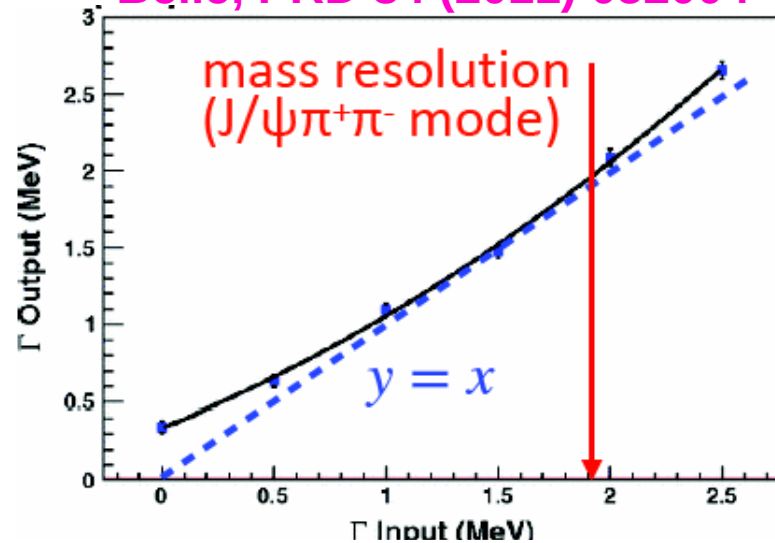

mode	Q value [MeV]
$J/\psi\pi^+\pi^-$	495.65 ± 0.17
$D^0\bar{D}^0\pi^0$	7.05 ± 0.18
$D^0\bar{D}^{0*}$	0.01 ± 0.18

- Due to very low Q value, the mass resolution is extremely good
 → expected great improvement in the width measurement with 50 ab^{-1}

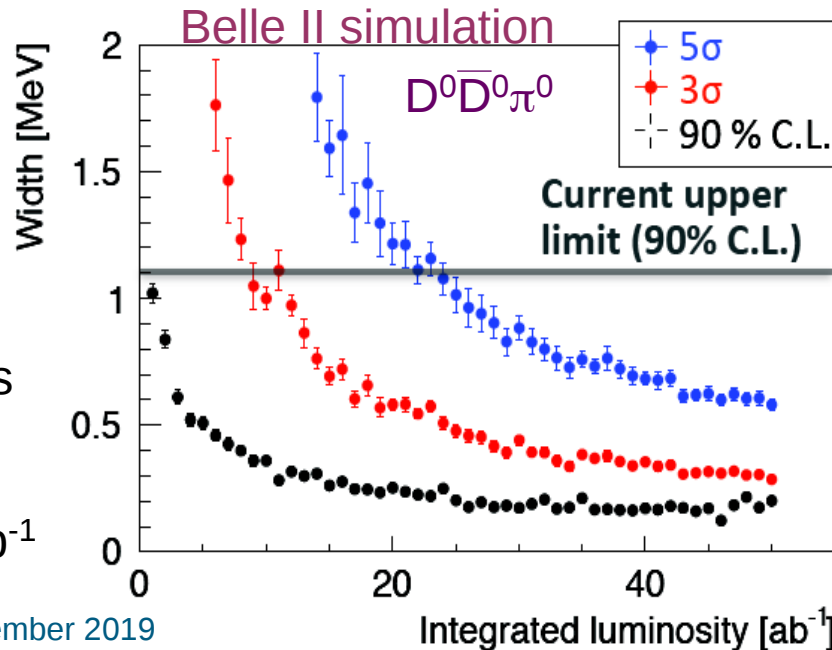

H. Hirata, Master thesis 2019

XYZ Expectations at Belle II



- Yield of $X(3872) \rightarrow J/\psi \pi^+ \pi^-$ in 2021 will be about Belle yield of $\psi' \rightarrow J/\psi \pi^+ \pi^-$
- Radiative decay $X(3872) \rightarrow J/\psi \gamma$: expected yield $N \approx 350$ in 2021
- The width of the $X(3872)$ could be measured with a systematic error of **± 0.11 MeV** in radiative X decay
 - \rightarrow **monoenergetic** photon provides 4-constraint fit ($\Delta E/E \sim 2\%$)
 - \rightarrow systematic error on width may be **~ 110 keV**
- Search for exotics at $D^* D^*$ threshold (better slow pion detection at Belle II)
 - slow pions reconstruction efficiency $> 60\%$ (L. Koch, Master Thesis 2016)

State	Production and Decay	N
$X(3872)$	$B \rightarrow K X(3872)$, $X(3872) \rightarrow J/\psi \pi^+ \pi^-$	$\simeq 14400$
$Y(4260)$	ISR, $Y(4260) \rightarrow J/\psi \pi^+ \pi^-$	$\simeq 29600$
$Z(4430)$	$B \rightarrow K^\mp Z(4430)$, $Z(4430) \rightarrow J/\psi \pi^\pm$	$\simeq 10200$

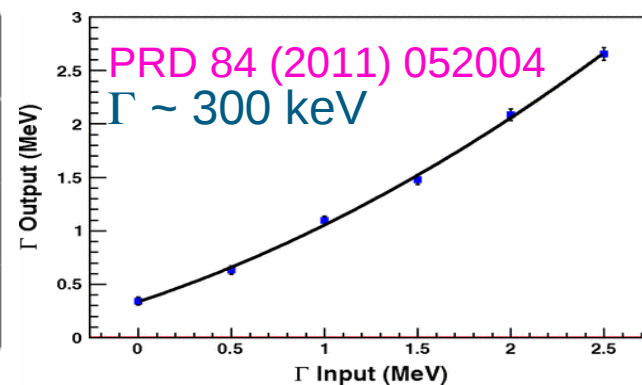

Expectation with 50ab^{-1} data at Belle II

Charmonium in ISR: Perspectives



- Line shape of the Y(4260)
- Strange partner of Z(3900) in KKJ/ψ
- Cross sections of exclusive $(c\bar{c}) + \text{hadrons}$

Golden Channels	$E_{c.m.}$ (GeV)	Statistical error (%)	Related XYZ states
$\pi^+\pi^- J/\psi$	4.23	7.5 (3.0)	Y(4008), Y(4260), $Z_c(3900)$
$\pi^+\pi^- \psi(2S)$	4.36	12 (5.0)	Y(4260), Y(4360), Y(4660), $Z_c(4050)$
$K^+K^- J/\psi$	4.53	15 (6.5)	Z_{cs}
$\pi^+\pi^- h_c$	4.23	15 (6.5)	Y(4220), Y(4390), $Z_c(4020)$, $Z_c(4025)$
$\omega\chi_{c0}$	4.23	35 (15)	Y(4220)

10 ab^{-1} 50 ab^{-1}

Why Bottomonium at Belle II?



- Bottomonium spectrum is significantly different from charmonium spectrum
 - n=3 state (3P) is below the threshold
 - L=2 state (1D) is below the threshold
- Z_b states were only found so far in $\Upsilon(5S)$ decays
- SuperKEKB can reach $E_{\text{c.m.}} \cong 11$ GeV
 - $\Rightarrow \Upsilon(6S)$ running possible – **unique possibility!**
- With the high luminosity, for the 1st time study **radiative transitions between bottomonia states possible** (suppressed by 1/137). Marginal statistics so far at Belle, big advantage at Belle II

Expectations on Z_b states at Belle II

- If Z_b is a loosely-bound state, several new molecular states should appear

$\Upsilon(6S)$ and $\Upsilon(5S)$: conventional state search

- Belle II goals:
 - search for new, predicted, resonances
 - use both, single transitions and double cascade
 - fill the remaining spectrum to measure the effect of the coupled channel contribution

$\Upsilon(6S)$ and $\Upsilon(5S)$: new exotics search

- Belle II goals:
 - $\Upsilon(6S)$: 100 fb^{-1} exploratory run
 - $\Upsilon(5S)$: 1 ab^{-1} high statistics run

$\Upsilon(6S)$ and $\Upsilon(5S)$: scan

- Belle II goals:
 - $\Upsilon(6S)$ and $\Upsilon(5S)$ behave differently in $\pi\pi\Upsilon$ and $\pi\pi\eta$
 → hint of a non- bb nature of $\Upsilon(5S)$?
 - investigate an extra resonance around $10.750 \text{ MeV}/c^2$

Settle the nature of $\Upsilon(5S)$

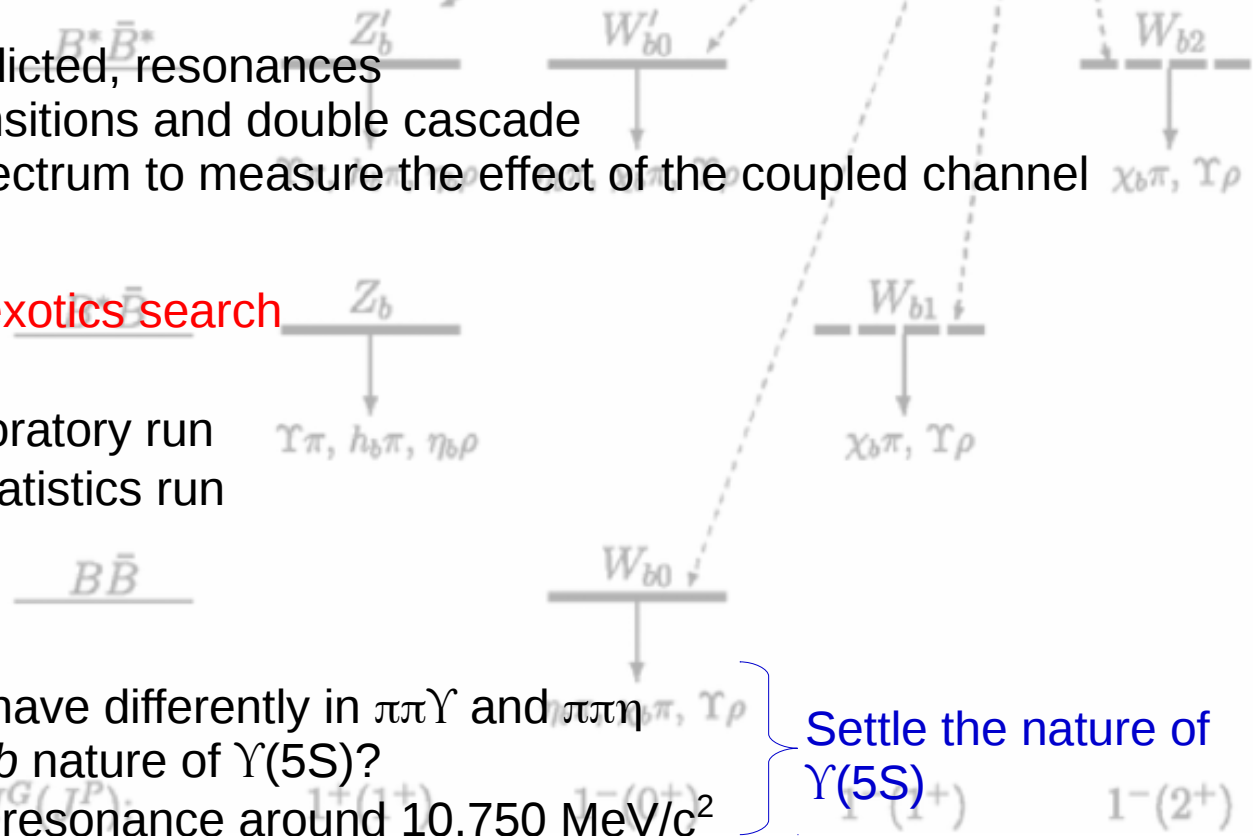

$\Upsilon(3S)$: Opportunities at Belle II



- Exotic states contribute to the hadronic and radiative transitions from narrow quarkonia

→ complementary approach to the direct search from $\Upsilon(5S)$ and $\Upsilon(6S)$

$\Upsilon(3S)$: exotics in transitions

- Belle II goals:
 - $\Upsilon(3S) \rightarrow \pi\pi\Upsilon(1S, 2S)$ still limited by statistics
 - perform full amplitude analysis
 - search for missing $\pi\pi/\eta$ transitions to constraint further theoretical models
 - study hindered radiative transitions

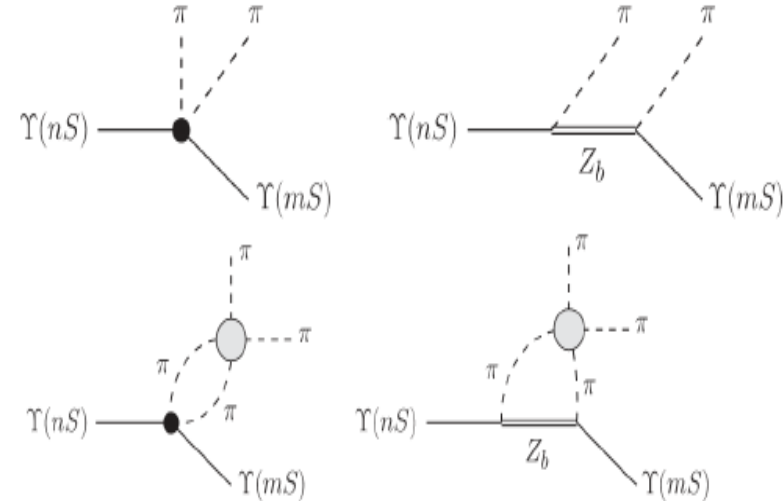

$\Upsilon(3S)$: charmonia in production

- Belle II goals with 300 fb^{-1} :
 - up to 5x sensitivity in inclusive production from $\Upsilon(3S)$
 - up to 15x in double charmonium
 - inclusive rate of $X(3872)$
 - $D\bar{D}^*$ correlation in $\Upsilon(3S) \rightarrow D\bar{D}^* + \text{hadron}$ to test the nature of the $X(3872)$

$\Upsilon(3S)$: rare χ_b decays

$\Upsilon(3S)$: deuteron production mechanism

“Re-discovery” with Phase 3 Data

J/ψ

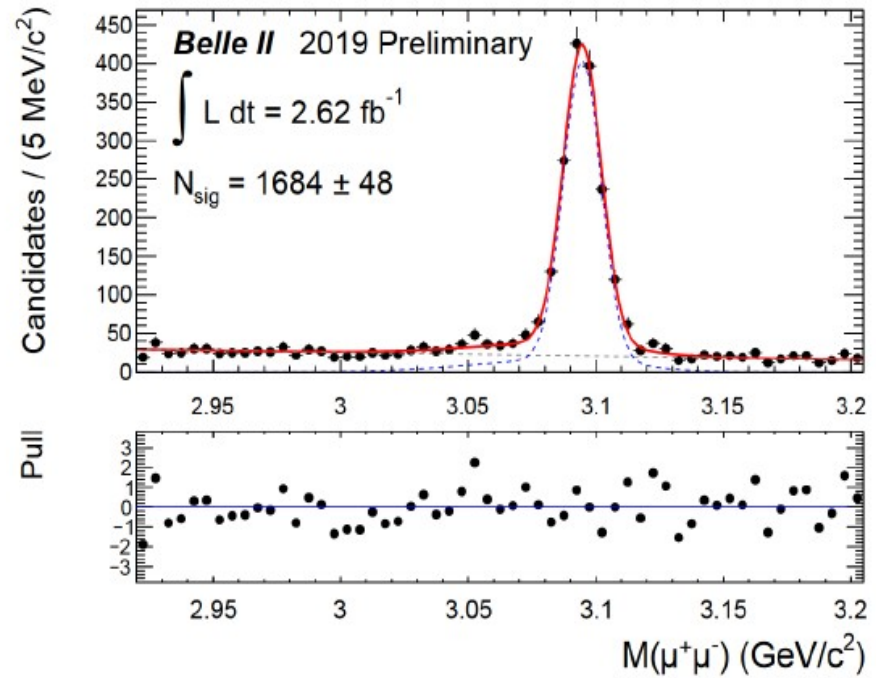
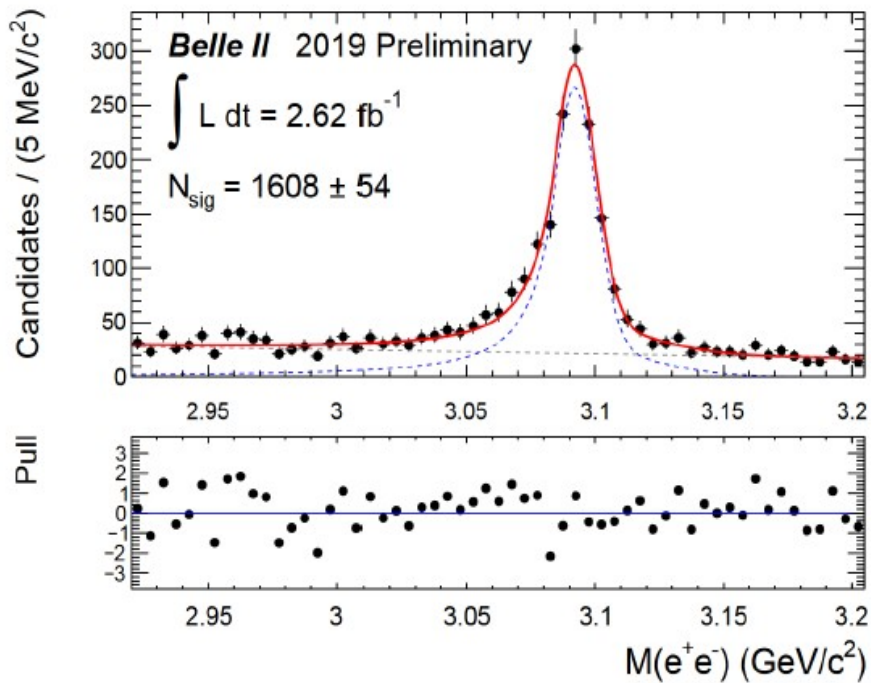

“Re-discovery” with Phase 3 Data

$\psi(2S)$

- Inclusive $\mu^+\mu^-$ search
- Isolate $\psi(2S) \rightarrow J/\psi \pi^+ \pi^-$ from ISR production

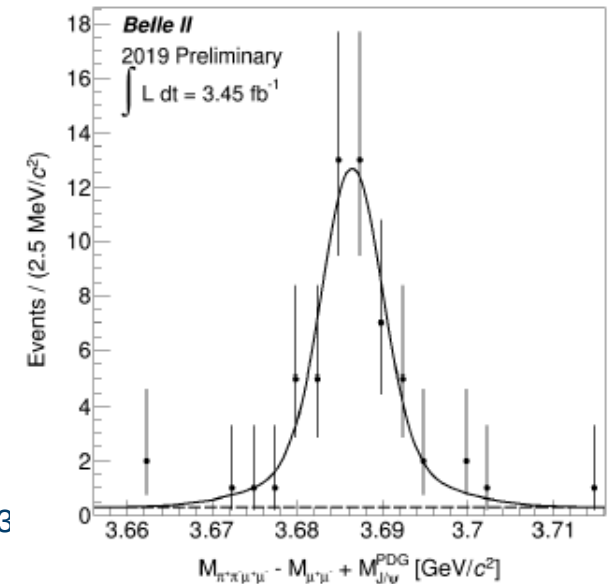
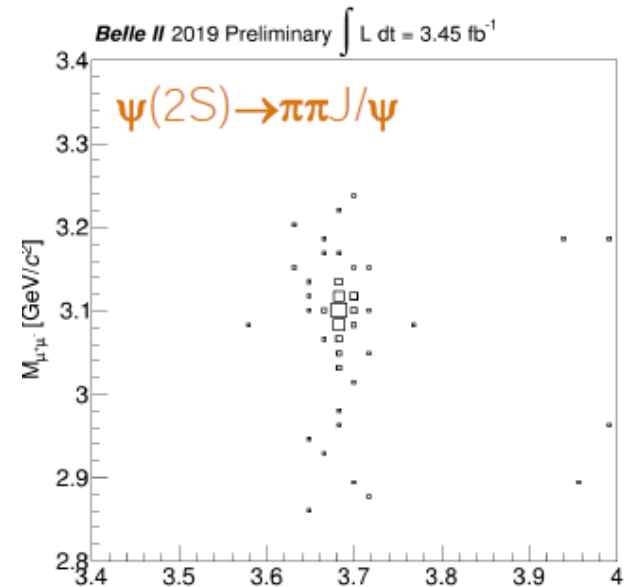
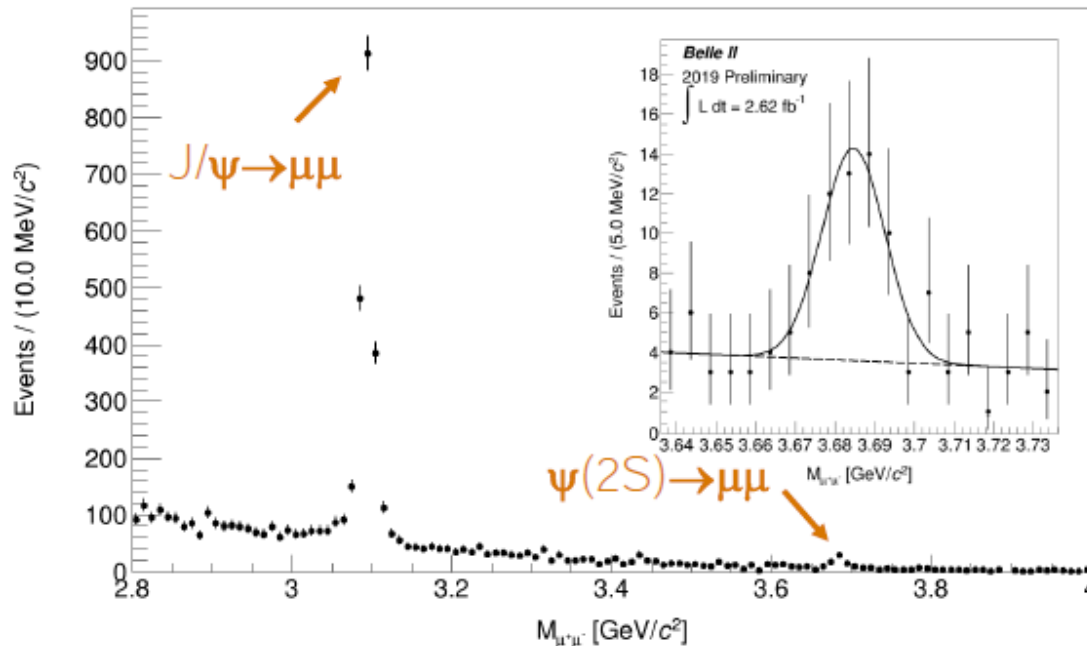

“Re-discovery” with Phase 3 Data

D^0 meson

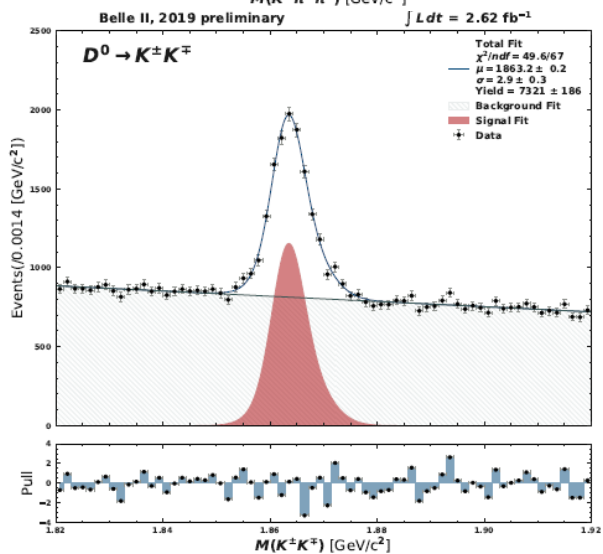
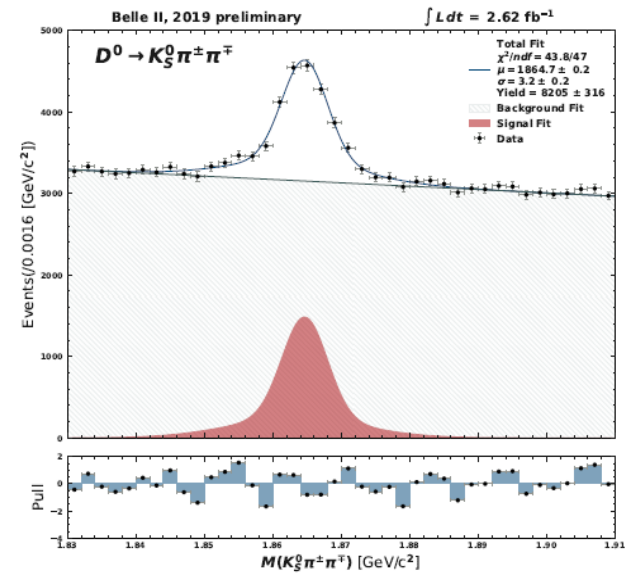
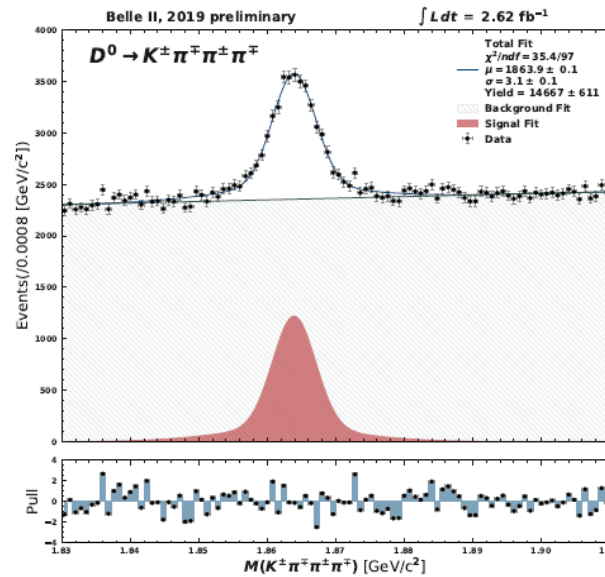
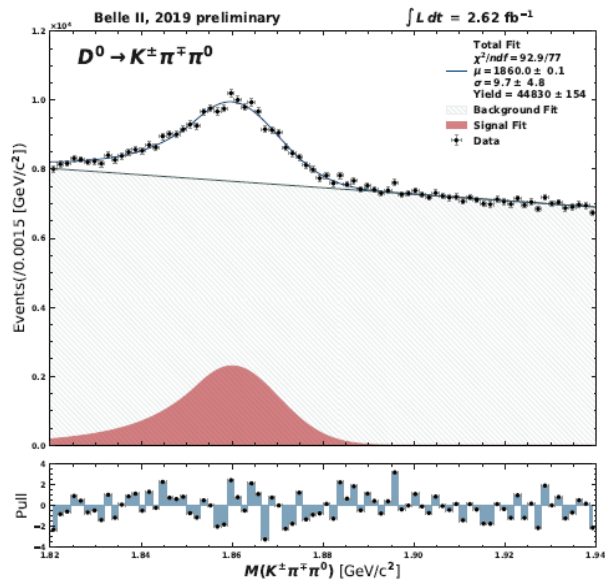

“Re-discovery” with Phase 3 Data

Fully hadronic B event reconstruction

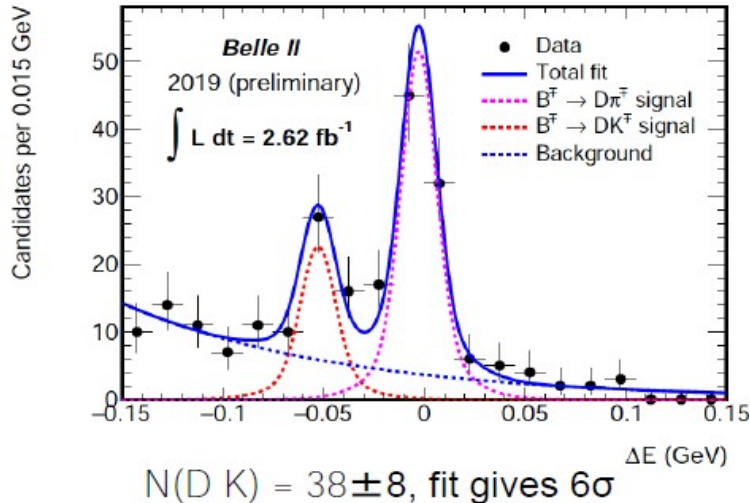
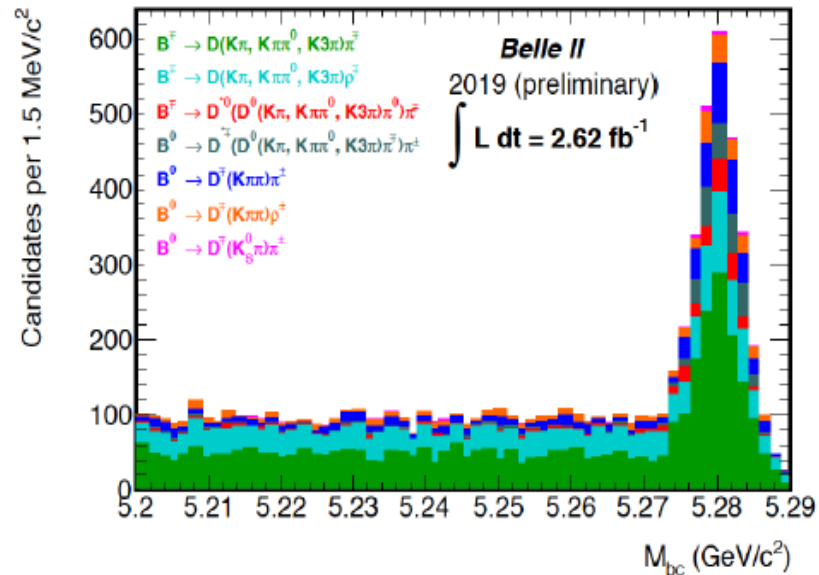
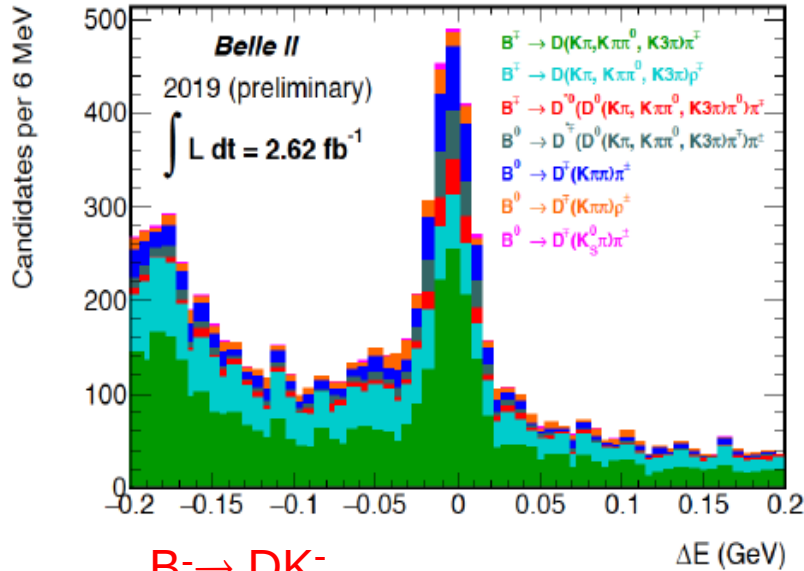

$$M_{bc} = \sqrt{(E_{cm} / 2)^2 - p_{recon}^2}$$

$$\Delta E = E_{cm} / 2 - E_{recon}$$

“Re-discovery” with Phase 3 Data

$\Upsilon(1S, 2S, 3S)$

ISR process: $\Upsilon(2S,3S) \rightarrow \Upsilon(1S)\pi^+\pi^-$

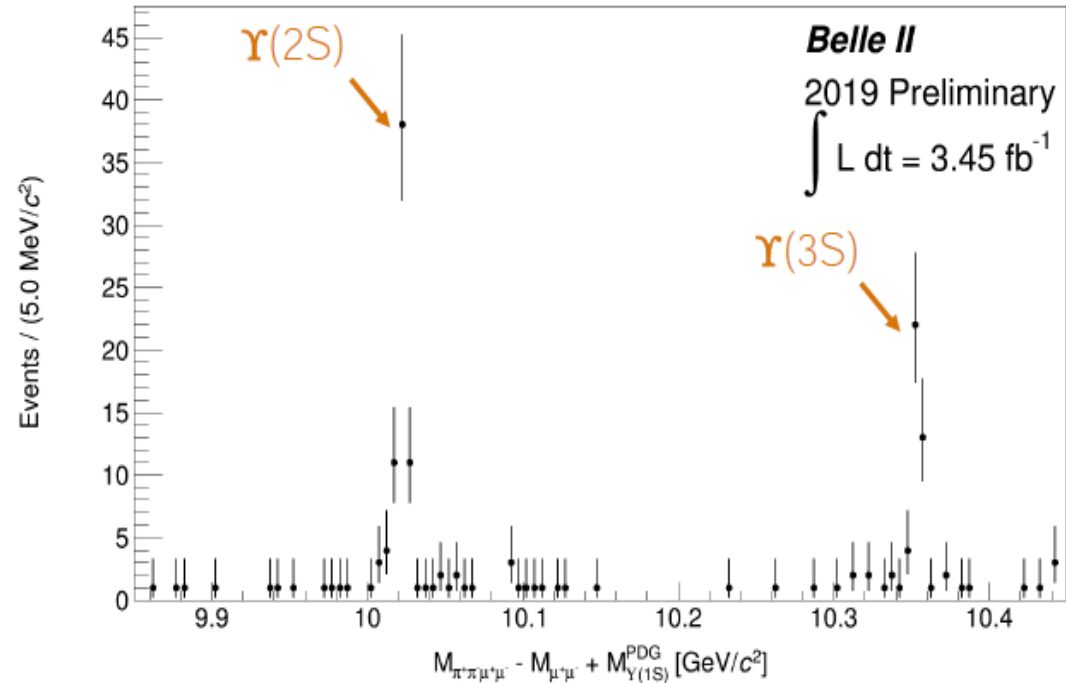
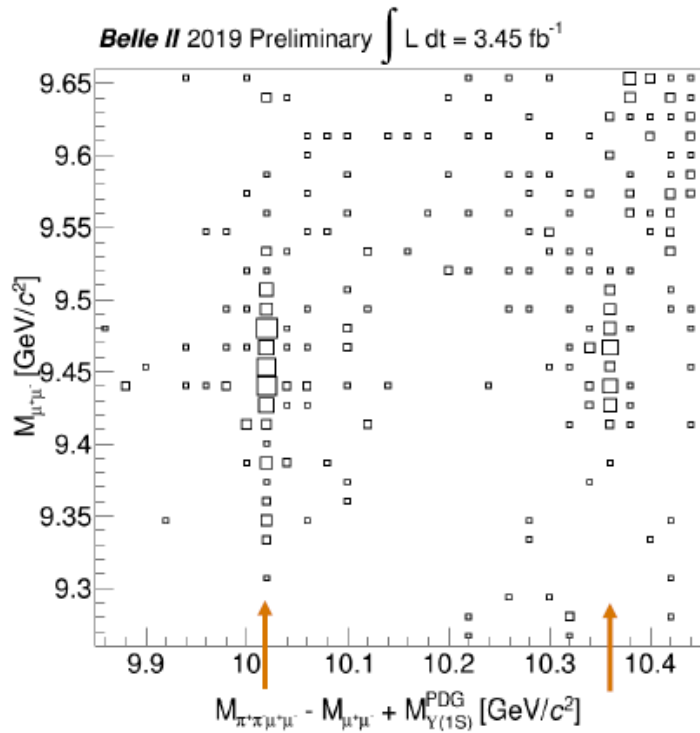

Summary

- Great achievements with Belle ($\sim 1 \text{ ab}^{-1}$) in spectroscopy, but still opportunities for unique physics with the new upgrade Belle II!
- In SuperKEKB e^+e^- collisions will reach unprecedented instantaneous
- luminosity: $8 \times 10^{35} \text{ cm}^{-2} \text{ s}^{-1}$.
- Improved tracking and PID in Belle II
- Phase 2 and 3 in Belle II completed!
- Expected by summer 2020: 200 fb^{-1}
- Expected 50 ab^{-1} integrated luminosity at Belle II in 7 years
- With x50 more data than Belle, expected in Belle II great achievements in hadron spectroscopy:
 - ISR analysis as unique case
 - favorite Bottomonium search through $\Upsilon(6S)$ compared to Belle
 - good slow pion reconstruction to search for $D^* \bar{D}^{(*)}$ threshold exotic states

The Belle II Collaboration

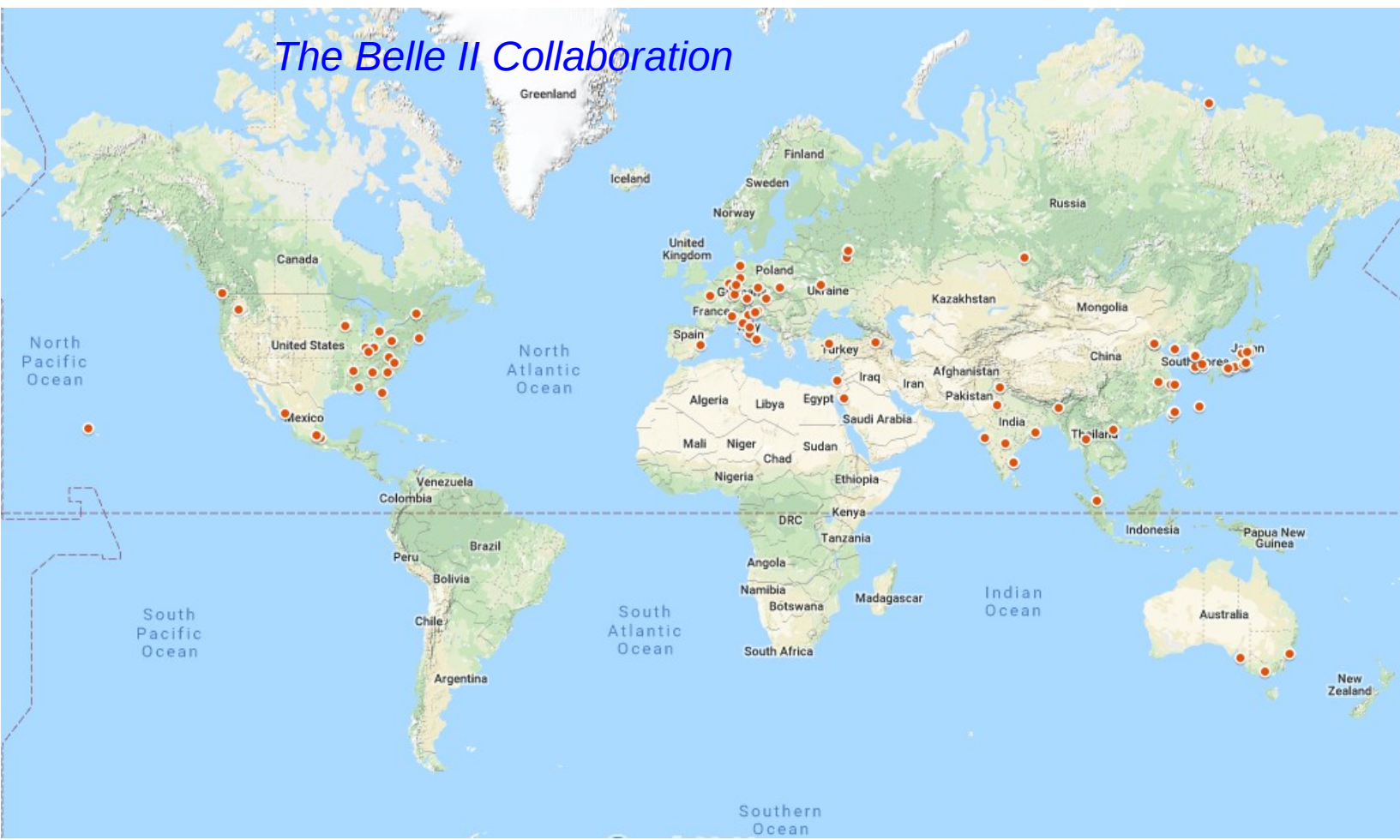

***Thank you for your
kind attention!***

e.prencipe@fz-juelich.de

Backup slides

How can Belle II perform these challenging measurements?

- most powerful e+e- collider in the world
- x40 more luminosity than Belle
- high vertex resolution
- excellent tracking performance
- improved slow pion detection

Vertex Pixel Detector (PXD)

VXD consists of 2 layers of DEPFET (Pixel Detector) and 4 layers of double-sided silicon microstrip sensors (Silicon Vertex Detector), assembled over carbon fiber ribs.

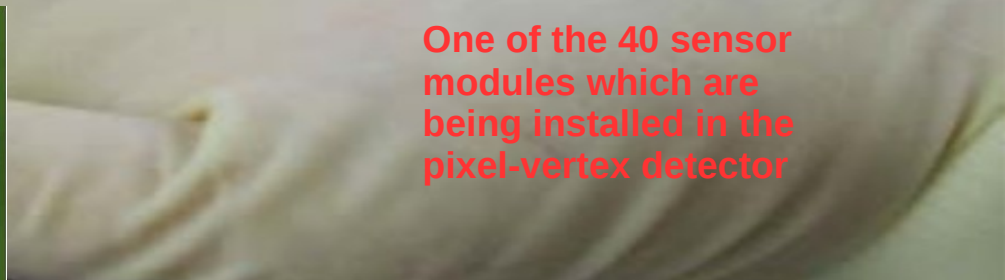
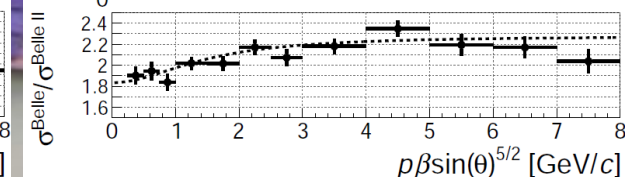
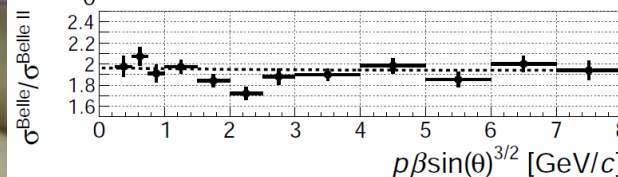
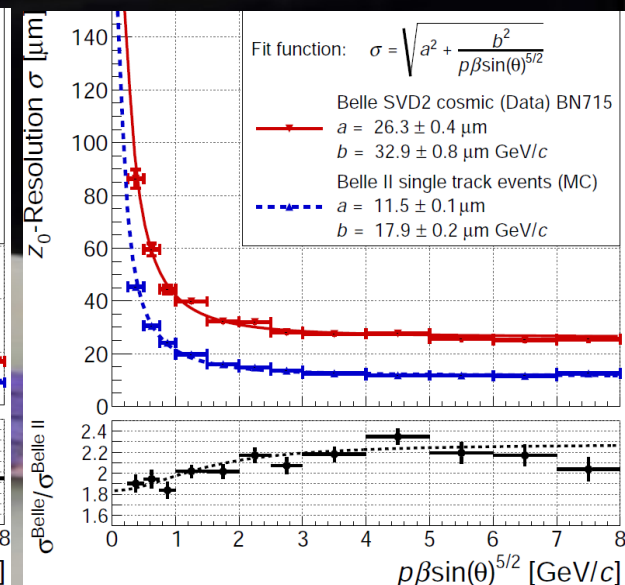
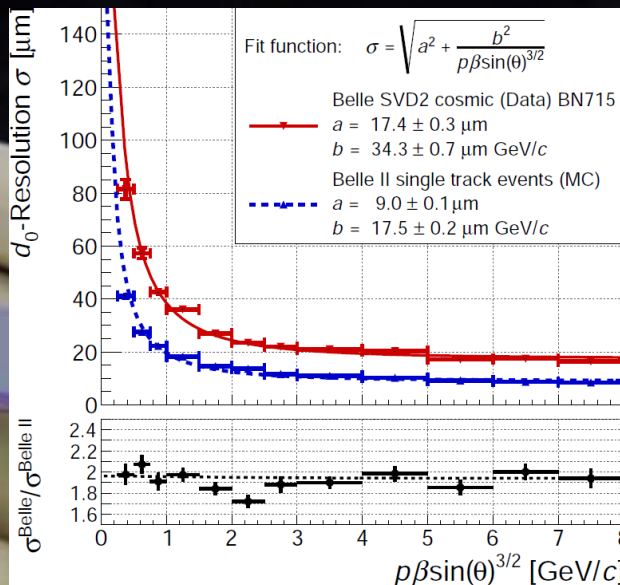
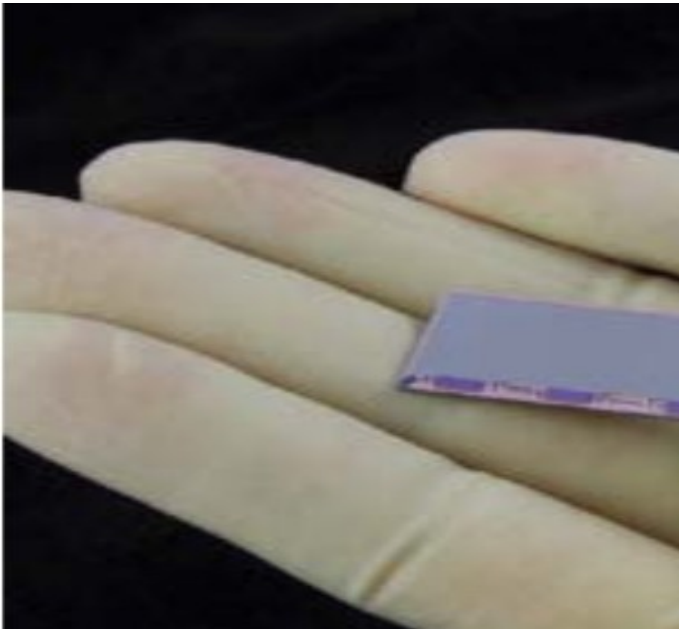

One of the 40 sensor modules which are being installed in the pixel-vertex detector

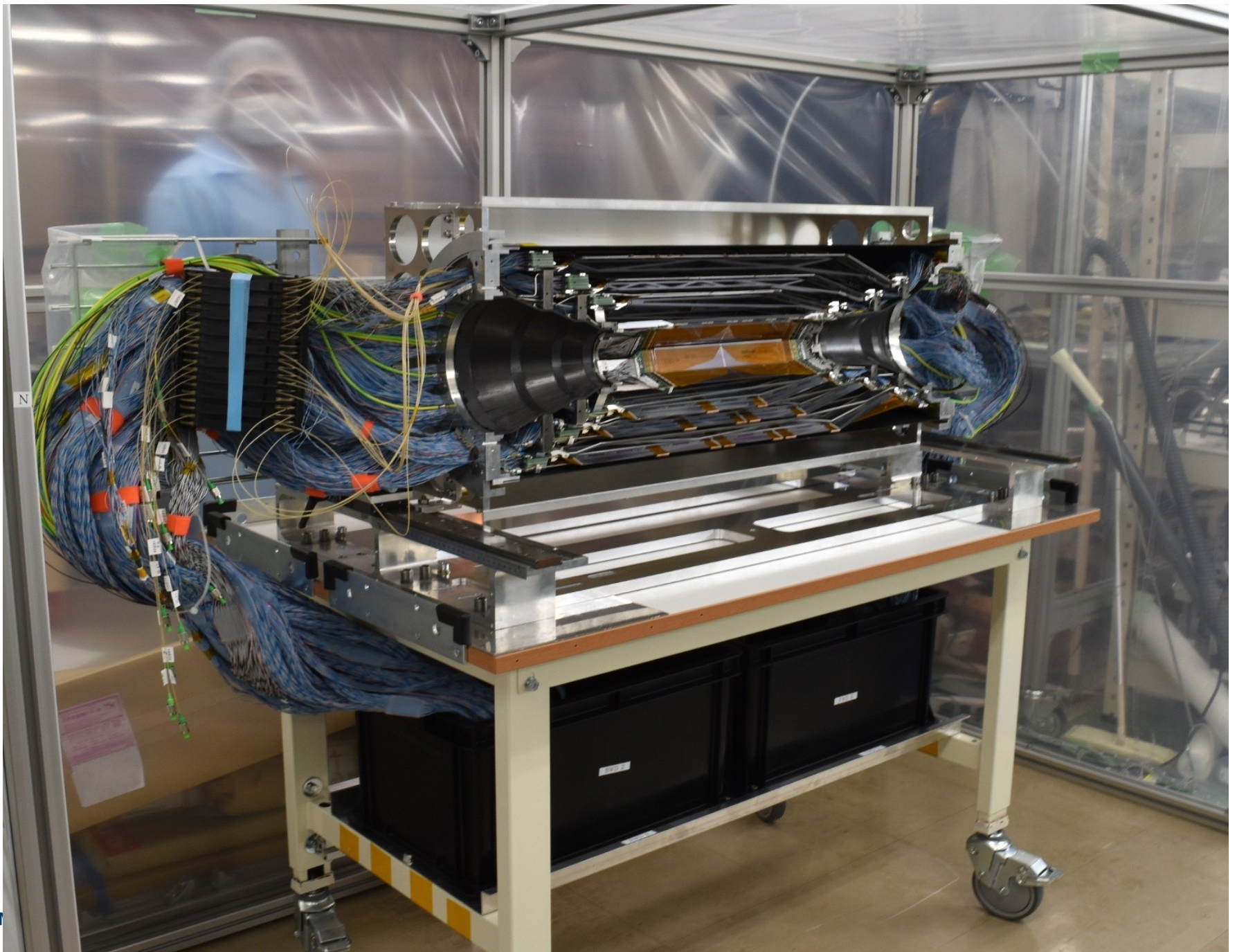

Central Drift Chamber (CDC)

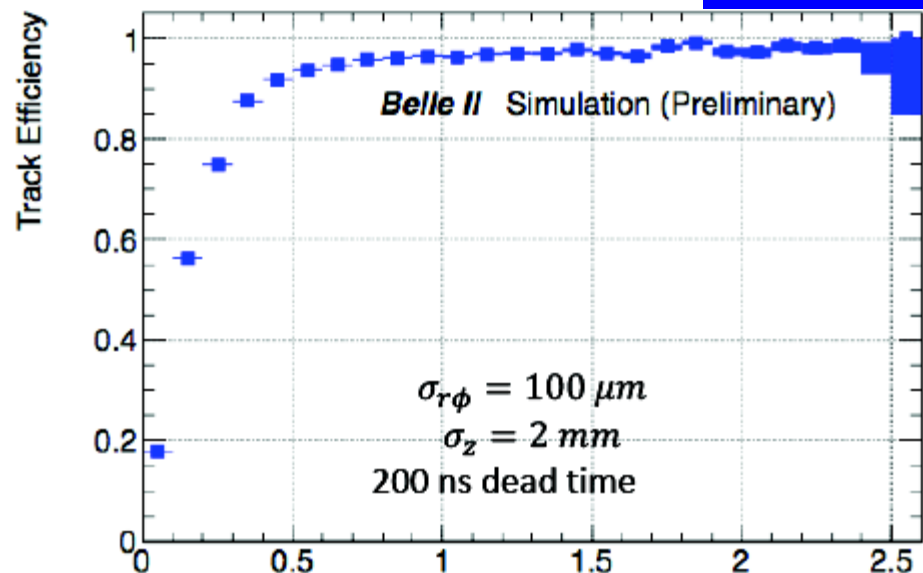
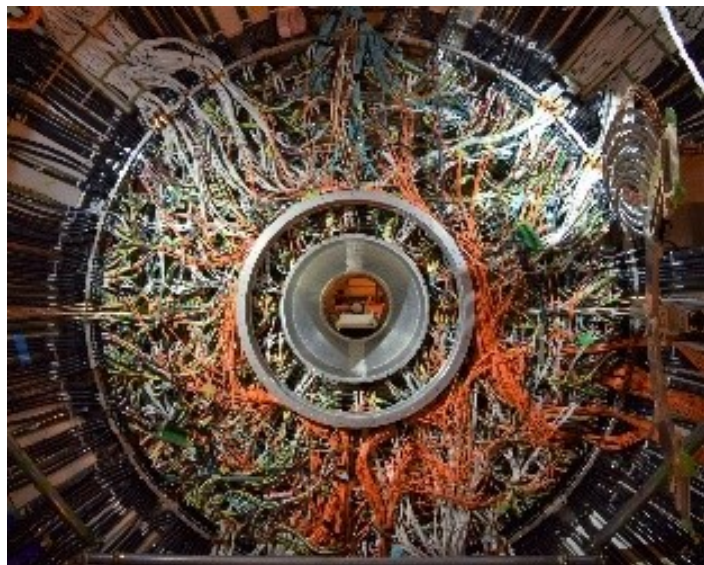

VXD + CDC hits
in EventDisplay

Jan 16, 2019:
First global SVD cosmic run

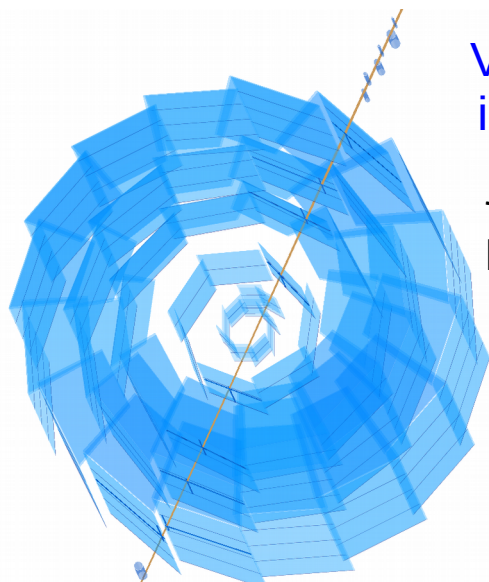

Exp. 5, Run 690, Evt. 14110
(Jan 27, 2019)

02- September 2019

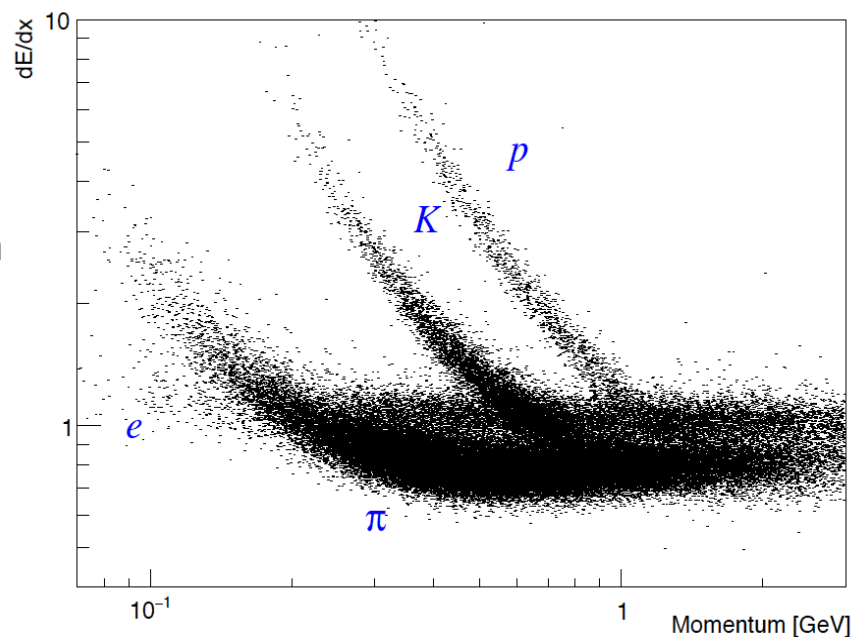

Cerenkov detector, laser in TOP module



Particle Identification

(Time-of-propagation, $t \leq 50$ ps)

Photo: K. Inami (Nagoya)

L ~ 2.5m, 16 barrels

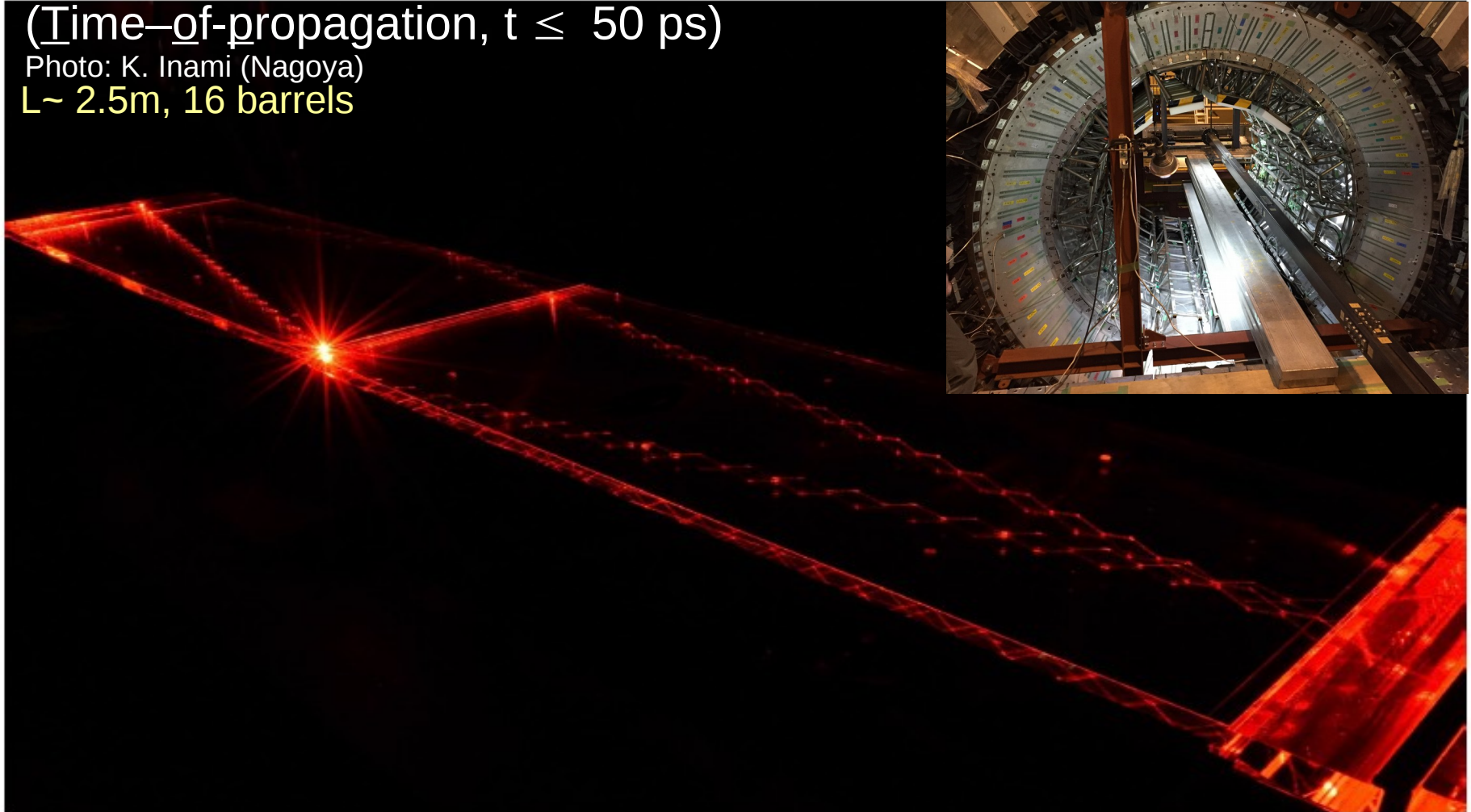

Main Achievements in Bottomonium at Belle

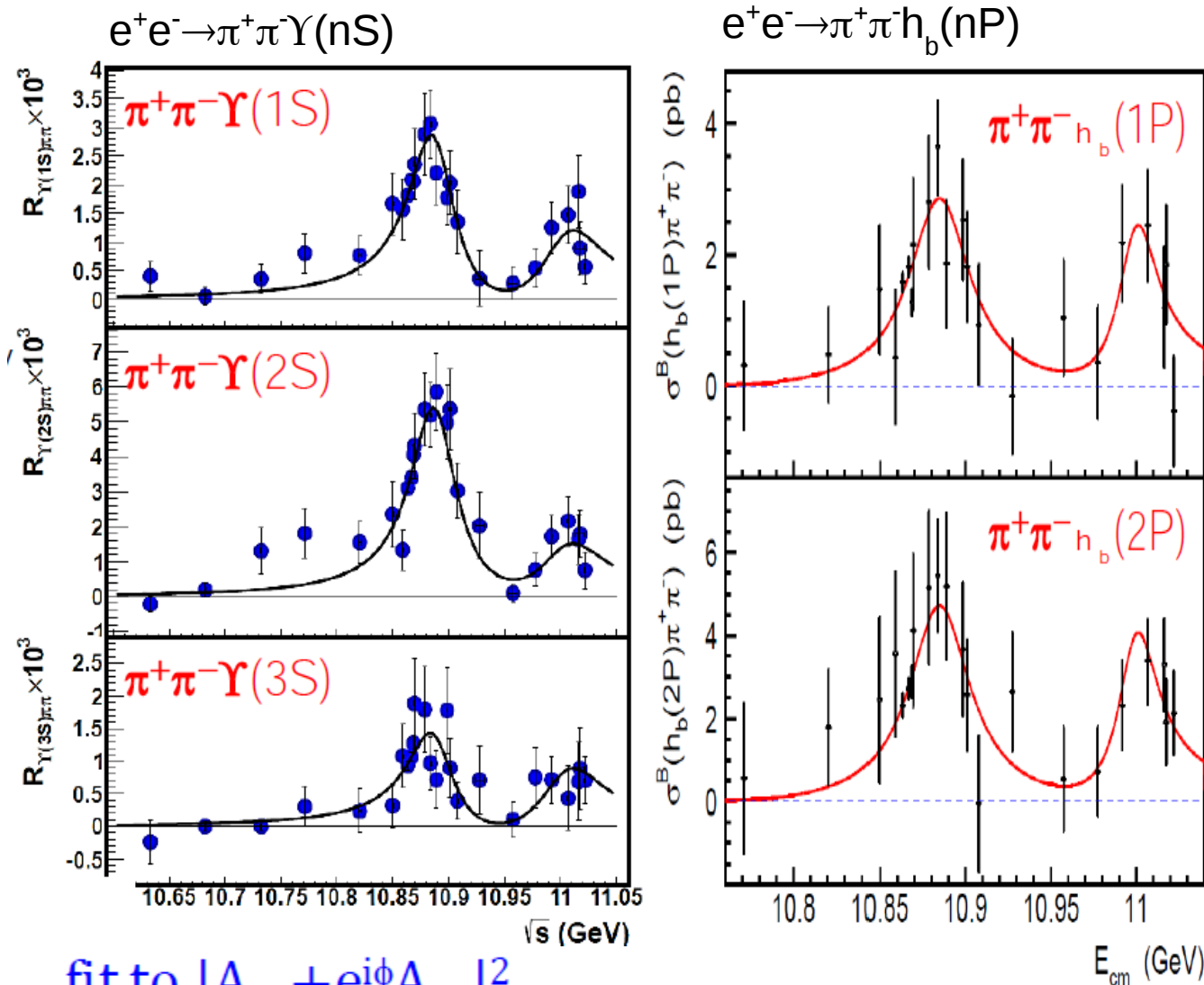

fit to $|A_{5S} + e^{i\phi}A_{6S}|^2$

PRD 93, 011101(R) (2016)

PRL117, 142001 (2016)

02- September 2019

Seite 35

Main Achievements in Bottomonium at Belle

Z_b in $\Upsilon(nS) \rightarrow \pi^+ \pi^- \Upsilon(nS)$

Parameter	$\Upsilon(1S)\pi^+\pi^-$	$\Upsilon(2S)\pi^+\pi^-$	$\Upsilon(3S)\pi^+\pi^-$
$f_{Z_b^\mp(10610)\pi^\pm}$, %	$4.8 \pm 1.2^{+1.5}_{-0.3}$	$18.1 \pm 3.1^{+4.2}_{-0.3}$	$30.0 \pm 6.3^{+5.4}_{-7.1}$
$Z_b(10610)$ mass, MeV/ c^2	$10608.5 \pm 3.4^{+3.7}_{-1.4}$	$10608.1 \pm 1.2^{+1.5}_{-0.2}$	$10607.4 \pm 1.5^{+0.8}_{-0.2}$
$Z_b(10610)$ width, MeV/ c^2	$18.5 \pm 5.3^{+6.1}_{-2.3}$	$20.8 \pm 2.5^{+0.3}_{-2.1}$	$18.7 \pm 3.4^{+2.5}_{-1.3}$
$f_{Z_b^\mp(10650)\pi^\pm}$, %	$0.87 \pm 0.32^{+0.16}_{-0.12}$	$4.05 \pm 1.2^{+0.95}_{-0.15}$	$13.3 \pm 3.6^{+2.6}_{-1.4}$
$Z_b(10650)$ mass, MeV/ c^2	$10656.7 \pm 5.0^{+1.1}_{-3.1}$	$10650.7 \pm 1.5^{+0.5}_{-0.2}$	$10651.2 \pm 1.0^{+0.4}_{-0.3}$
$Z_b(10650)$ width, MeV/ c^2	$12.1^{+11.3+2.7}_{-4.8-0.6}$	$14.2 \pm 3.7^{+0.9}_{-0.4}$	$9.3 \pm 2.2^{+0.3}_{-0.5}$
ϕ_Z , degrees	$67 \pm 36^{+24}_{-52}$	$-10 \pm 13^{+34}_{-12}$	$-5 \pm 22^{+19}_{-33}$
$c_{Z_b(10650)}/c_{Z_b(10610)}$	$0.40 \pm 0.12^{+0.05}_{-0.11}$	$0.53 \pm 0.07^{+0.32}_{-0.11}$	$0.69 \pm 0.09^{+0.18}_{-0.07}$
$f_{\Upsilon(nS)f_2(1270)}$, %	$14.6 \pm 1.5^{+6.3}_{-0.7}$	$4.09 \pm 1.0^{+0.33}_{-1.0}$	—
$f_{\Upsilon(nS)(\pi^+\pi^-)_S}$, %	$86.5 \pm 3.2^{+3.3}_{-4.9}$	$101.0 \pm 4.2^{+6.5}_{-3.5}$	$44.0 \pm 6.2^{+1.8}_{-4.3}$
$f_{\Upsilon(nS)f_0(980)}$, %	$6.9 \pm 1.6^{+0.8}_{-2.8}$	—	—

$\sigma_{Z_b^\pm(10610)\pi^\mp} \times \mathcal{B}_{\Upsilon(1S)\pi^\mp} = 109 \pm 27^{+35}_{-10}$ fb	$\sigma_{Z_b^\pm(10650)\pi^\mp} \times \mathcal{B}_{\Upsilon(1S)\pi^\mp} = 20 \pm 7^{+4}_{-3}$ fb
$\sigma_{Z_b^\pm(10610)\pi^\mp} \times \mathcal{B}_{\Upsilon(2S)\pi^\mp} = 737 \pm 126^{+188}_{-85}$ fb	$\sigma_{Z_b^\pm(10650)\pi^\mp} \times \mathcal{B}_{\Upsilon(2S)\pi^\mp} = 165 \pm 49^{+43}_{-20}$ fb
$\sigma_{Z_b^\pm(10610)\pi^\mp} \times \mathcal{B}_{\Upsilon(3S)\pi^\mp} = 438 \pm 92^{+92}_{-114}$ fb	$\sigma_{Z_b^\pm(10650)\pi^\mp} \times \mathcal{B}_{\Upsilon(3S)\pi^\mp} = 194 \pm 53^{+43}_{-25}$ fb

Nano-Beam Scheme

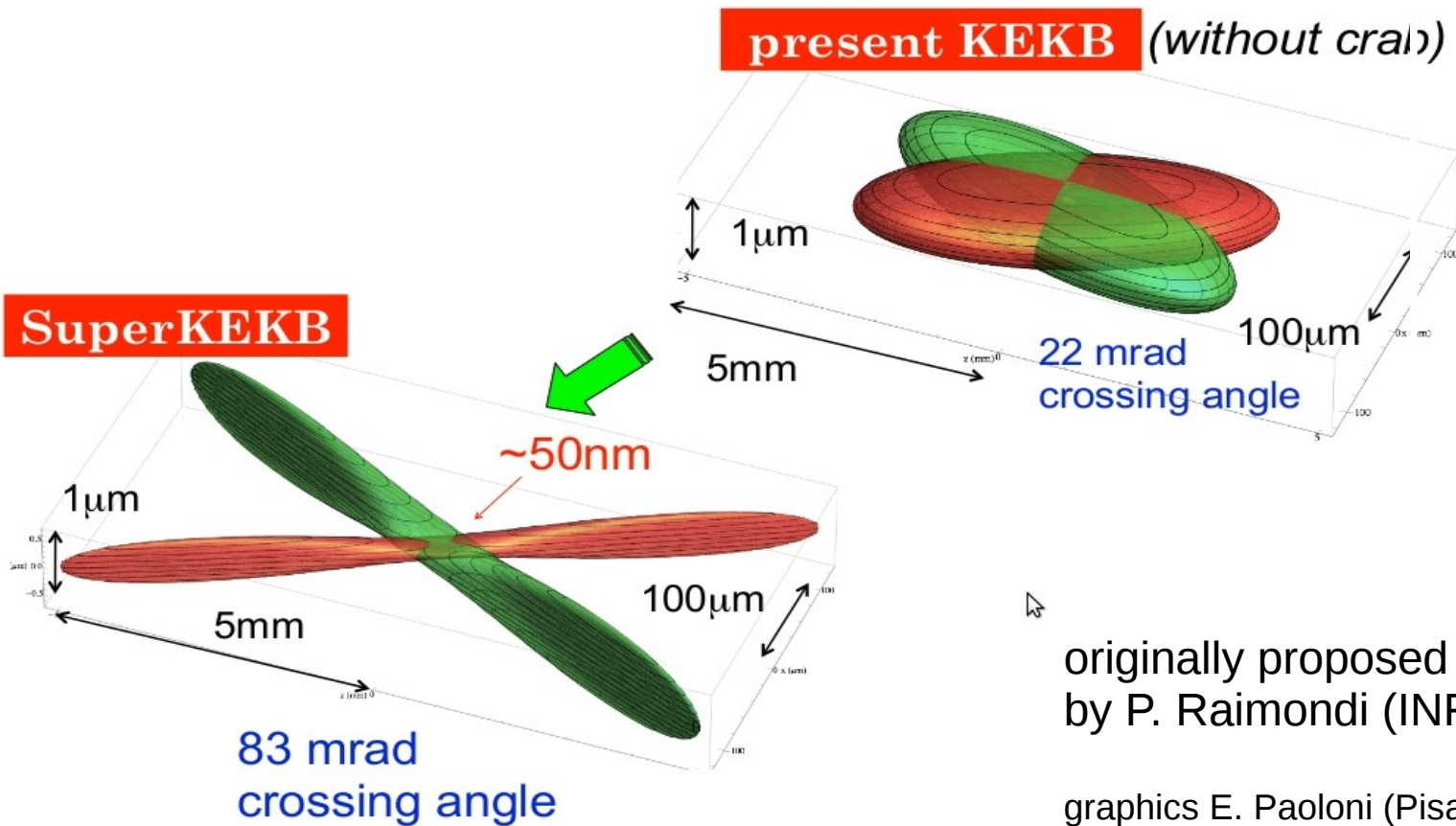

X(3872): ACHIEVEMENTS AND INTERPRETATION AT BELLE

~150 events in 10 years

Belle. Phys Rev D84(2011)052004

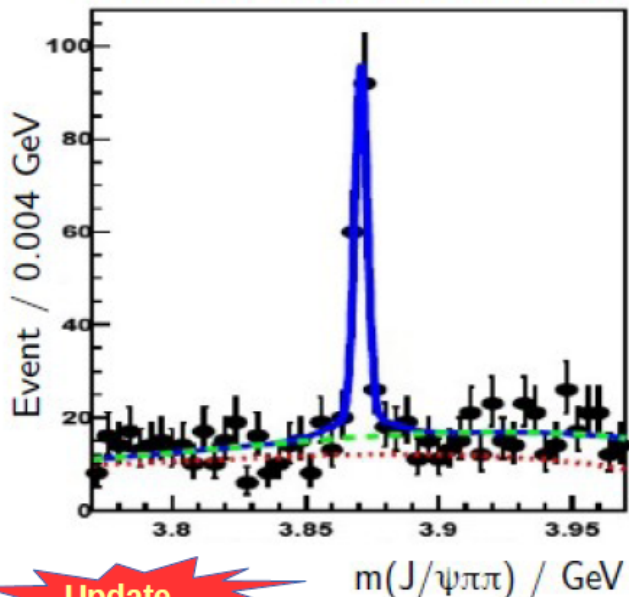

$$M_{X(3872)} = (3871.85 \pm 0.27(\text{stat}) \pm 0.19(\text{syst})) \text{ MeV}$$

$$B(B^+ \rightarrow K^+ X(3872)) \times B(X(3872) \rightarrow \pi^+ \pi^- J/\psi) =$$

$$(8.63 \pm 0.82(\text{stat}) \pm 0.52(\text{syst})) \times 10^{-6}$$

$$B(B^0 \rightarrow K^0 X(3872)) / B(B^+ \rightarrow K^+ X(3872)) =$$

$$0.50 \pm 0.14(\text{stat}) \pm 0.04(\text{syst})$$

$$\Delta M_{X[B^0-B^+]} = (-0.71 \pm 0.96(\text{stat}) \pm 0.19(\text{syst})) \text{ MeV.}$$

- X(3872) observed in different decay modes, and different production mechanisms
- At $D\bar{D}^*$ threshold $E_B = 160 \pm 330 \text{ keV}$, but no threshold effect
- $\Gamma \leq 1.2 \text{ MeV}$ → too narrow! Bugg, JPHG35 (2008) 075005
- The $D\bar{D}^*$ decay of the X(3872) is dominant ~ x10 than other X(3872) decay modes → a molecule?
- Isospin-violating decay: $B(X(3872) \rightarrow J/\psi \rho)$, $\sim 10^2$ too large

X(3872): ACHIEVEMENTS AND INTERPRETATION AT BELLE

- Correlation function from MC
 $\Gamma(\text{output}) = f(\Gamma(\text{input}))$
- 3-dim fits validated with ψ' width
 $\Gamma_{\psi'} = 0.52 \pm 0.11$ MeV
(PDG: 0.304 ± 0.009 MeV)
→ bias 0.23 ± 0.11 MeV
- procedure for upper limit:
width in 3-dim fit fixed
 n_{signal} and n_{BG} floating
→ calculate likelihood
- $\Gamma_{X(3872)} < 0.95$ MeV + bias

PRD 84 (2011) 052004

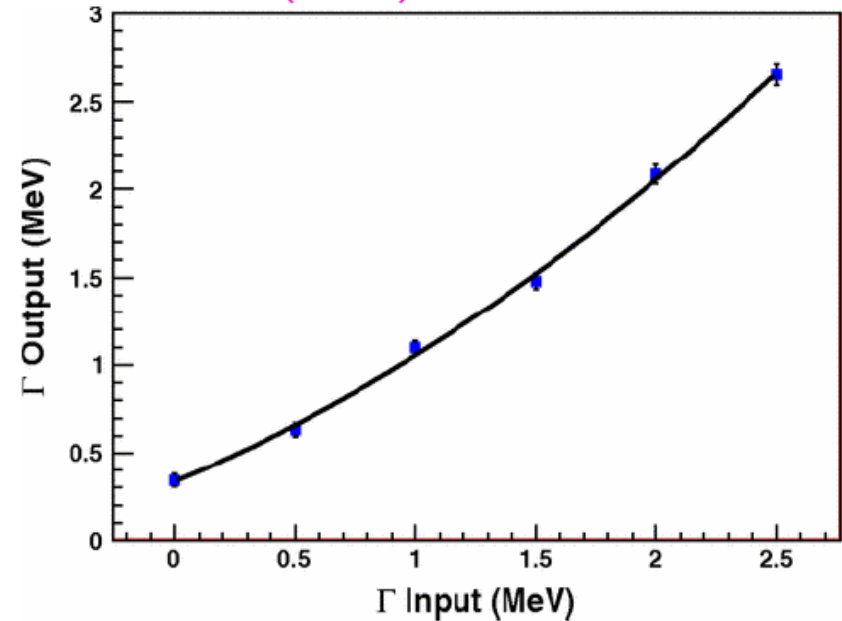

Reference channel: $B \rightarrow \psi(2s)\pi^+\pi^-$

X(3872): ACHIEVEMENTS AND INTERPRETATION AT BELLE

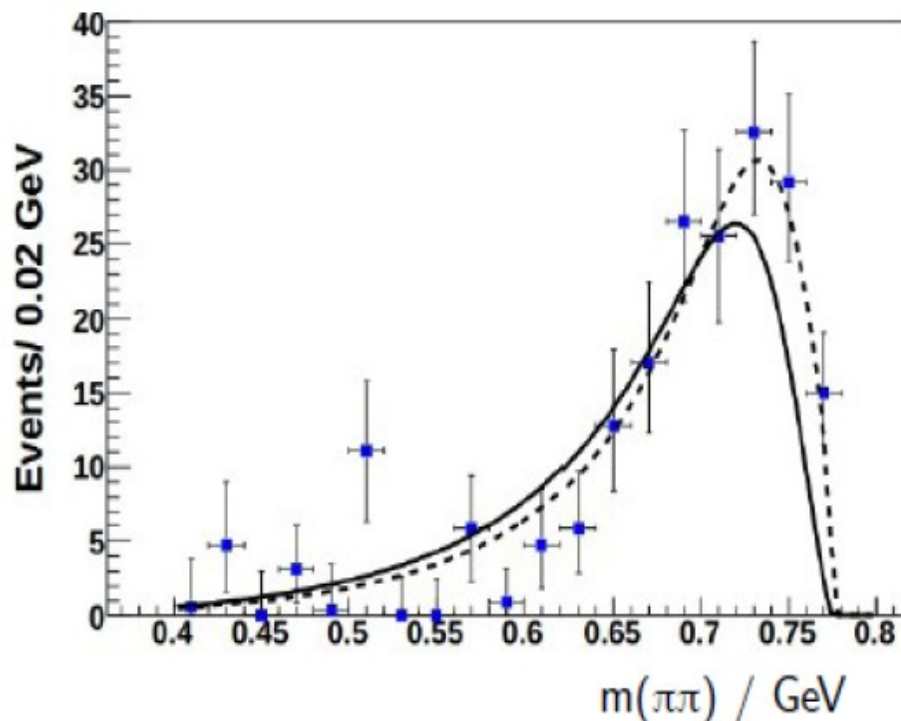

- Isospin-violating decay:
 $B(X(3872) \rightarrow J/\psi \rho)$, factor 10^2 too large
 $J^{PC} = 1^{++}$, predicted nearby χ_{c1}'
Barnes et al, PRD72 (2005) 054026
- Mass ≥ 50 MeV higher
- Width ≥ 100 larger

What can be done better to disclose the nature of the X(3872)?

X(3872)

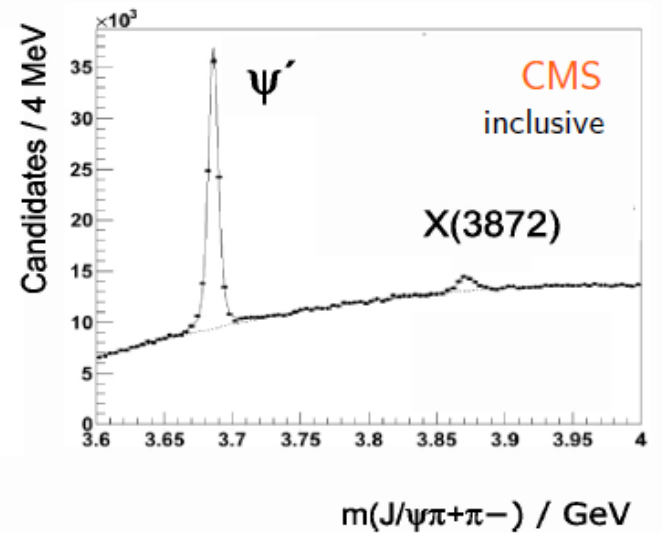
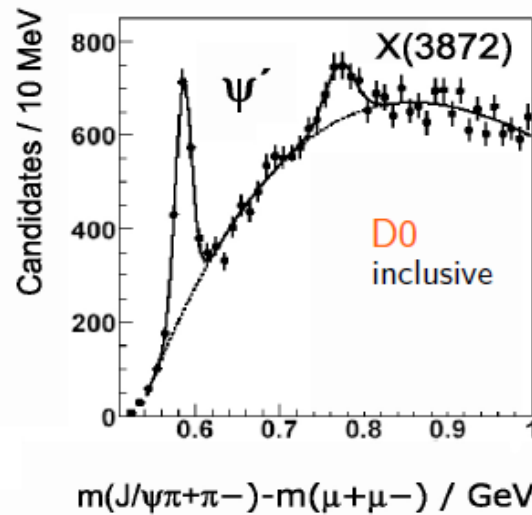
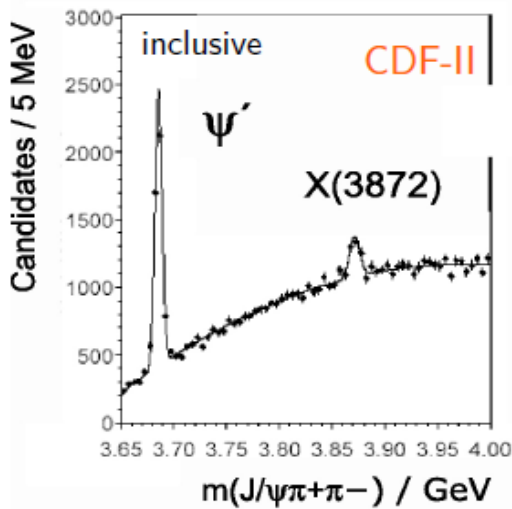
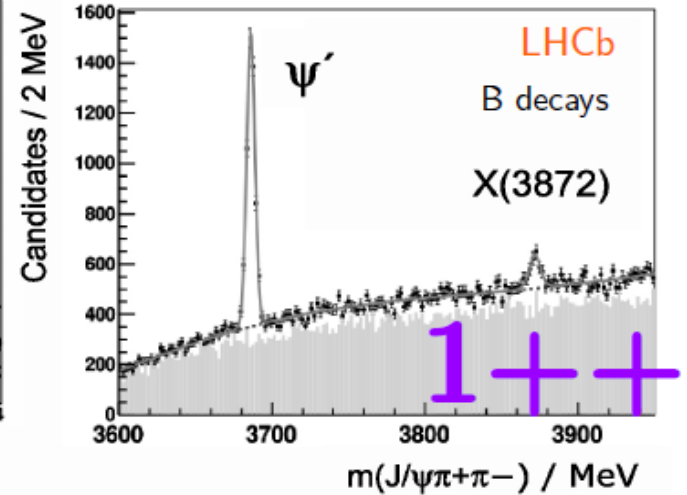
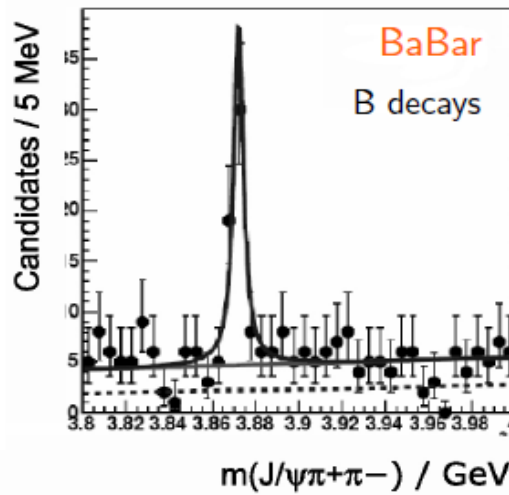
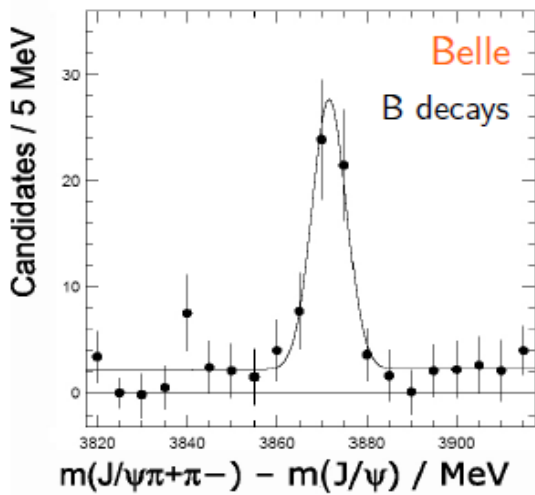

Photoproduction of X(3872)

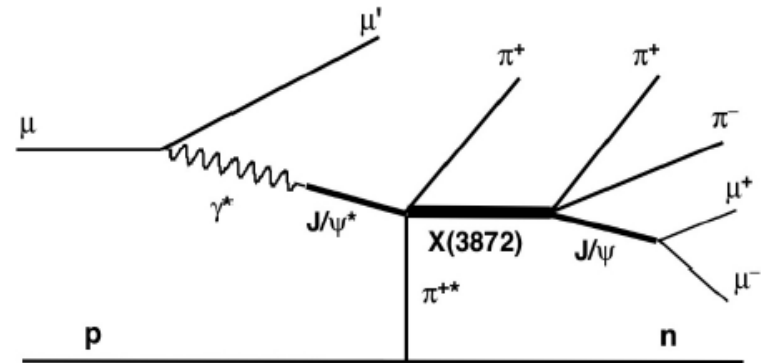

Muon data 2003-2010

$$N_{\psi(2S)} = 16.1 \pm 5.2$$

$$N_{X(3872)} = 13.9 \pm 4.9$$

$$\sigma_M = 20.6 \pm 6.1 \text{ MeV}$$

COMPASS, arXiv:1707.01796 [hep-ex]

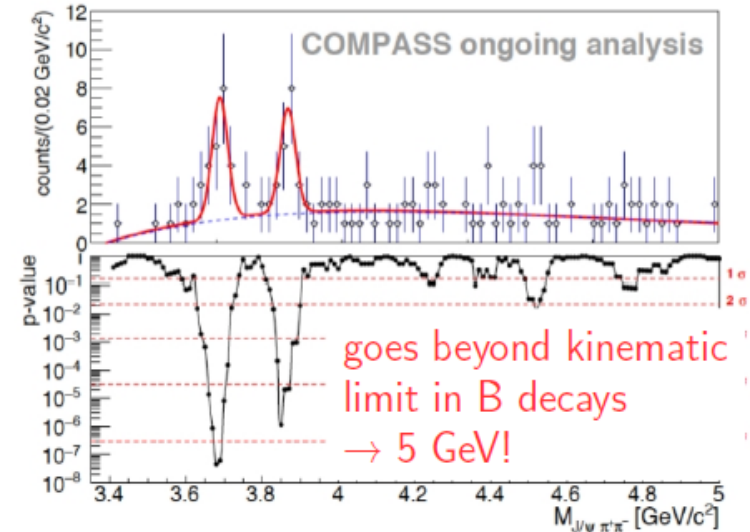

Is the X(3872) exotic ?

TETRAQUARK



$$[qQ]_8[\bar{q}\bar{Q}]_8$$

Diquarks
are colored

Maiani, Riquer, Piccinini, Polosa, Burns;
Ebert, Faustov, Galkin; Chiu, Hsieh;
Ali, Hambrock, Wang

THRESHOLD CUSP

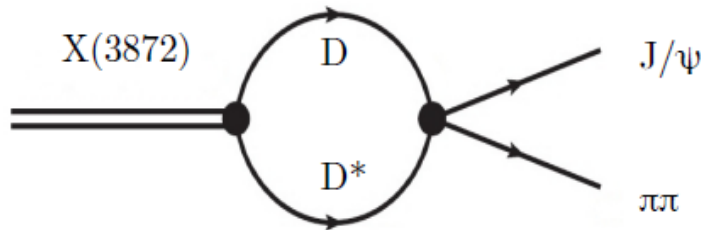

Bugg; Swanson

MOLECULE

Intriguing Analogon

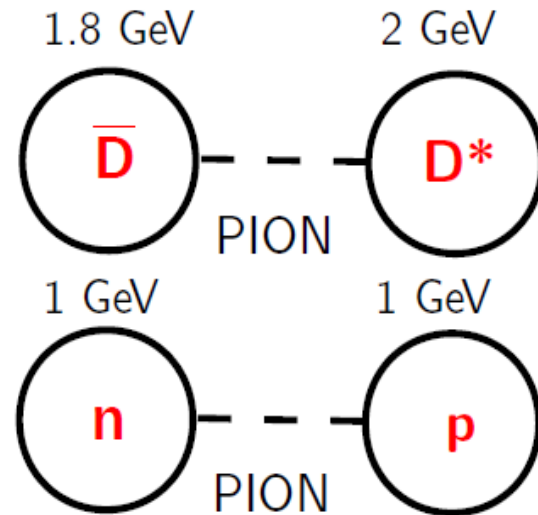

Tornqvist; Swanson; Braaten, Kusunoki,
Wong; Voloshin; Close, Page
Guo, Hanhart, Meissner

courtesy of J.S. Lange, HIRSCHEGG2018

Y STATES

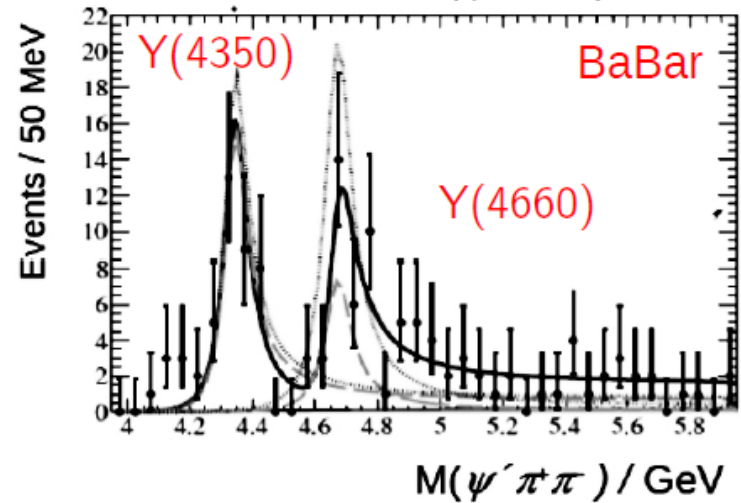
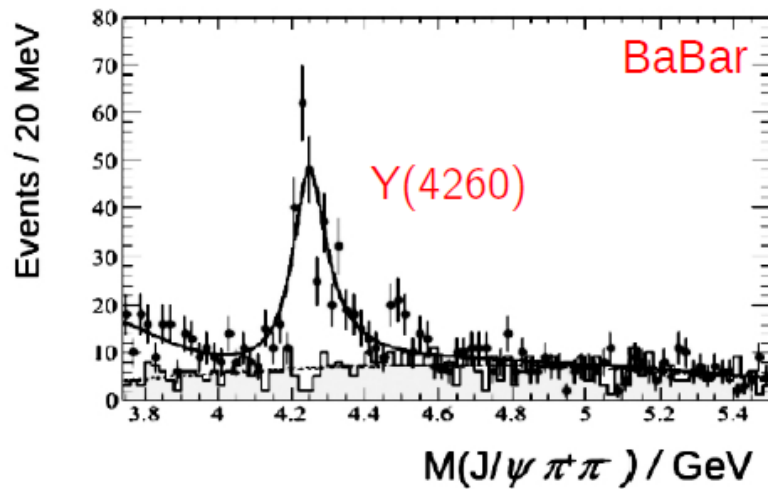
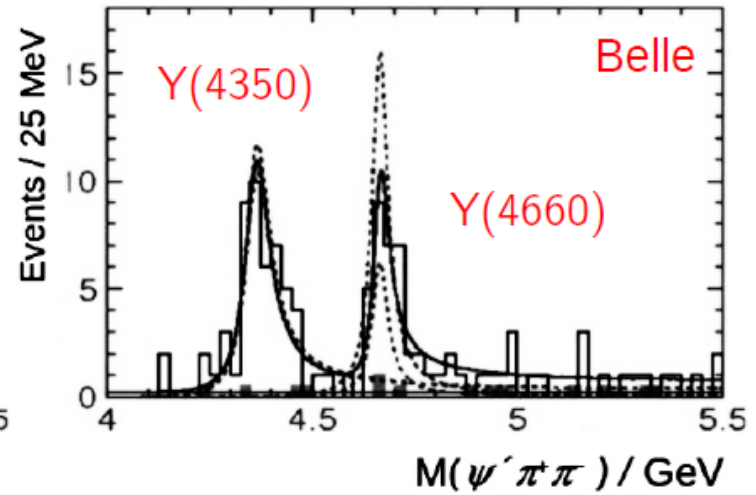
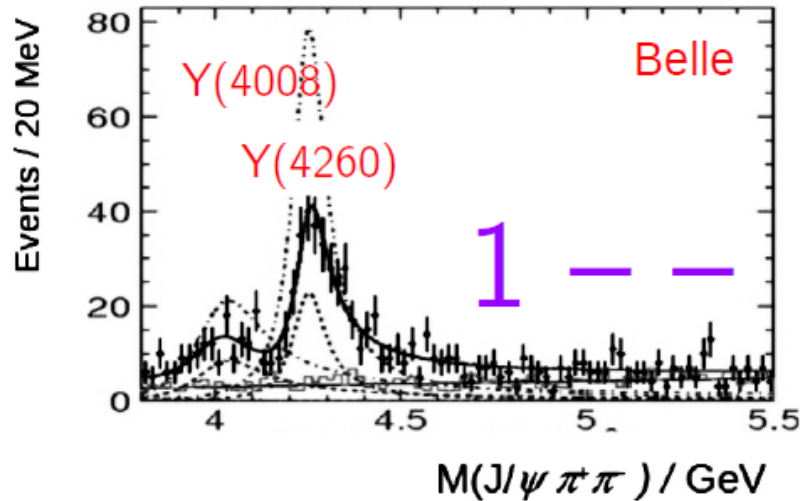

Cornell-Potential

Eichten, Gottfried, et al. PRD 17(1978)3090
 Barnes, Godfrey, Swanson, PRD 72(2005)054026

- Coulomb-Potential
 + Confinement-Term

$$V(r) = -\frac{4\alpha_s}{3r} + \boxed{kr}$$

spin-spin $+\frac{32\pi\alpha_s}{9m_c^2}\delta_r\vec{S}_c\vec{S}_{\bar{c}}$

spin-orbit $+\frac{1}{m_c^2}\left(\frac{2\alpha_s}{r^3} - \frac{k}{2r}\right)\vec{L}\vec{S}$

tensor $+\frac{1}{m_c^2}\frac{4\alpha_s}{r^3}\left(\frac{3\vec{S}_c\vec{r}\cdot\vec{S}_{\bar{c}}\vec{r}}{r^2} - \vec{S}_c\vec{S}_{\bar{c}}\right)$

- solve Schrödinger equation
 (quark mass heavy → non-relativistic)
 → states

$$\Psi(r, \theta, \phi) = R_{nl}(r)Y_{lm}(\theta, \phi)$$

$$\left[-\frac{1}{m_q} \left(\frac{\partial^2}{\partial r^2} + \frac{2}{r} \frac{\partial}{\partial r} + \frac{l(l+1)}{m_q r^2} + V(r) \right) \right] R_{nl}(r) = E_{nl} R_{nl}(r)$$

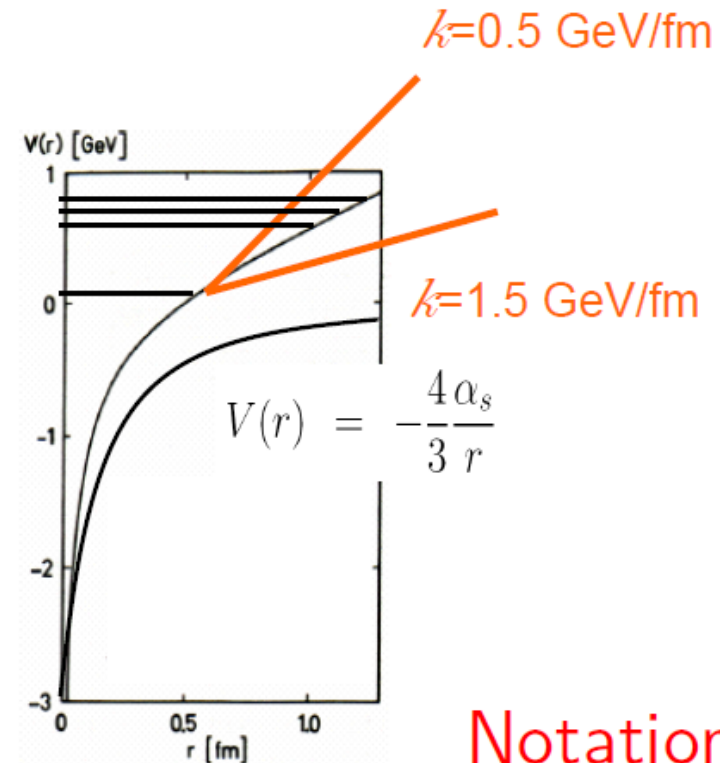

Notation
 $n^{2S+1}L_J$
 JPC

Cornell potential: Wronski-Determinant must be zero at turning point

$$r_{\text{turning point}} = \frac{E - 2m}{2\sigma} + \sqrt{\frac{4m^2 - 4mE + E^2}{4\sigma^2} + \frac{4\alpha_s}{3\sigma}}$$

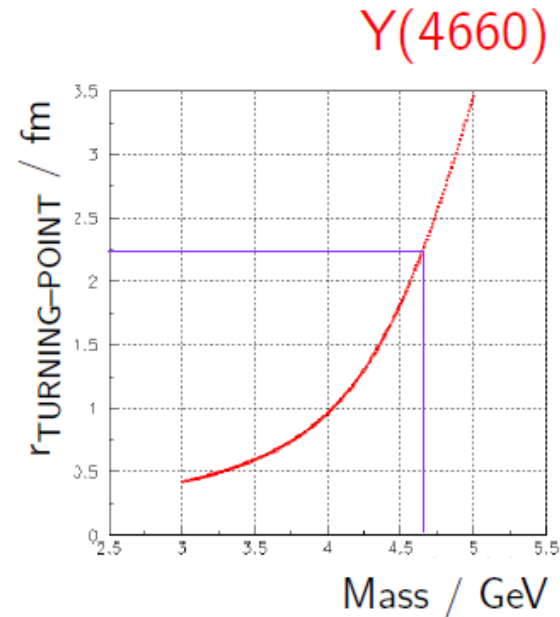
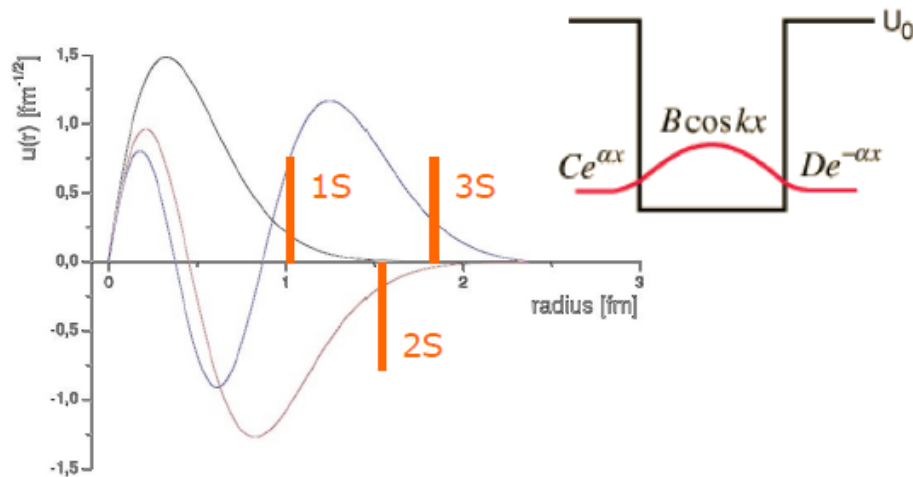

- $m=4.660$ GeV \rightarrow turning point of wave function is **2.2 fm!**
- large fraction of wave function in string breaking regime $r>1.4$ fm

courtesy of J.S. Lange, HIRSCHEGG2018

Charmonium vs. Positronium

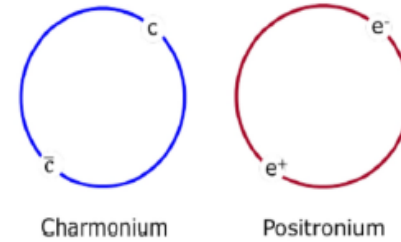

Decays to light quarks suppressed
 → narrow widths

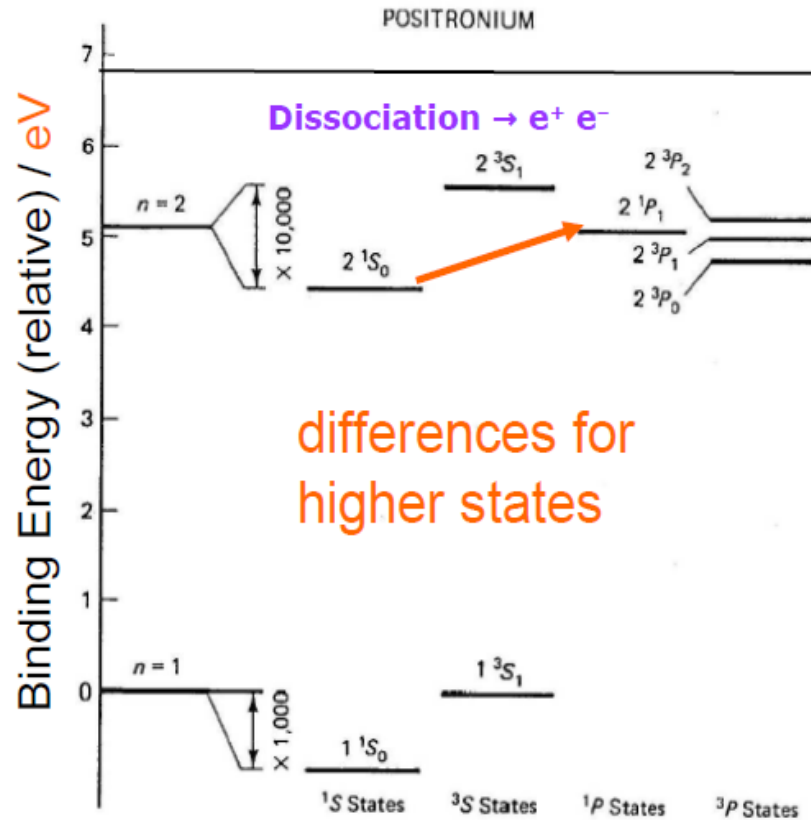
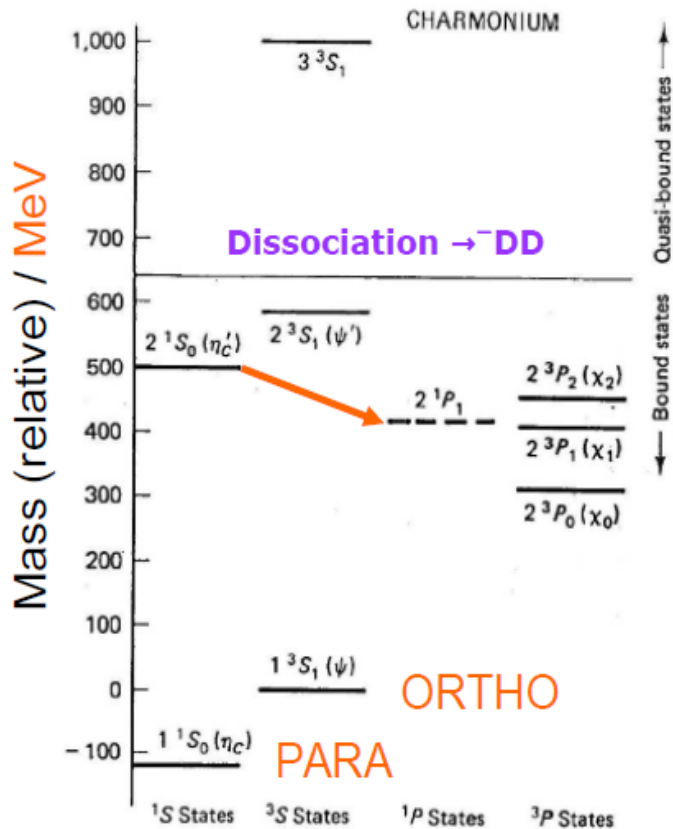

courtesy of J.S. Lange, HIRSCHEGG2018



Z STATES AT BESIII

$\bar{D}D^*$ threshold

$D^*\bar{D}^*$ threshold

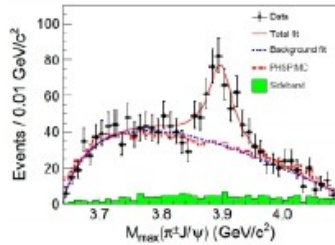

$e^+e^- \rightarrow \pi^+ \pi^- J/\Psi$

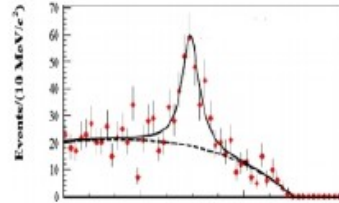

$e^+e^- \rightarrow \pi^0 \pi^0 J/\Psi$

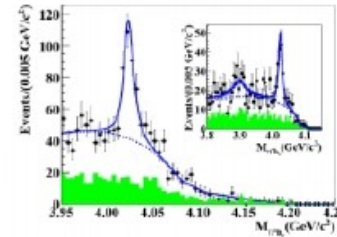

$e^+e^- \rightarrow \pi^+ \pi^- h_c$

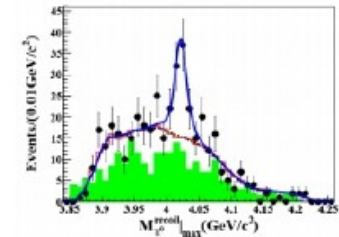

$e^+e^- \rightarrow \pi^0 \pi^0 h_c$

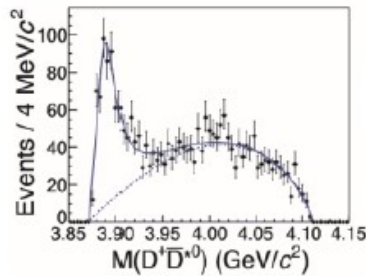

$e^+e^- \rightarrow \pi^+ (D\bar{D}^*)^-$

charged

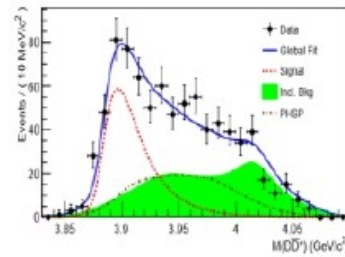

$e^+e^- \rightarrow \pi^0 (D\bar{D}^*)^0$

neutral

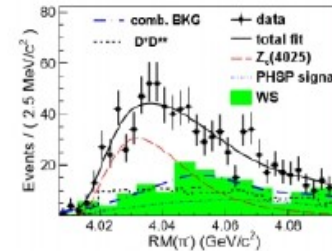

$e^+e^- \rightarrow \pi^+ (D^* \bar{D}^*)^-$

charged

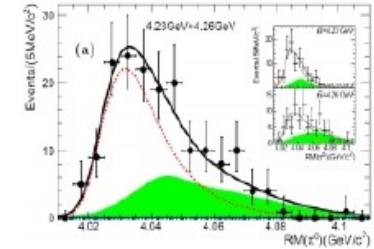

$e^+e^- \rightarrow \pi^0 (D^* \bar{D}^*)^0$

neutral

Recent hot topic: neutral partners \rightarrow isospin triplets
All of them $1+$, wherever tested.

Z states and „confinement“ ?

All measured Z_c^+ masses are above $D^{(*)}\bar{D}^{(*)}$ thresholds

State	m (MeV)	Threshold	Δm (MeV)
$Z_c(3900)$	$3899.0 \pm 3.6 \pm 4.9$	$D^+\bar{D}^{0*}$	+22.4
$Z_c(3900)$	$3899.0 \pm 3.6 \pm 4.9$	$D^0\bar{D}^{+*}$	+23.9
$Z_c(3900)$	$3894.5 \pm 6.6 \pm 4.5$	$D^+\bar{D}^{0*}$	+17.9
$Z_c(3900)$	$3894.5 \pm 6.6 \pm 4.5$	$D^0\bar{D}^{+*}$	+19.4
$Z_c(3900)$	$3885 \pm 5 \pm 1$	$D^+\bar{D}^{0*}$	+8.4
$Z_c(3900)$	$3885 \pm 5 \pm 1$ MeV	$D^0\bar{D}^{+*}$	+9.9
$Z_c(3885)$	$3883.9 \pm 1.5 \pm 4.2$	$D^+\bar{D}^{0*}$	+7.4
$Z_c(3885)$	$3883.9 \pm 1.5 \pm 4.2$	$D^0\bar{D}^{+*}$	+8.8
$Z_c(4020)$	$4022.9 \pm 0.8 \pm 2.7$	$D^{0*}\bar{D}^{\pm*}$	+5.6
$Z_c(4025)$	$4026.3 \pm 2.6 \pm 3.7$	$D^{0*}\bar{D}^{\pm*}$	+9.0
$Z_c(4032)^+$	$\simeq 4032.1 \pm 2.4$	$D^{0*}\bar{D}^{\pm*}$	+15.0

	possible?
threshold CUSP	no (must be @ threshold)
tetraquark	yes (spin–spin forces)
molecules	no, if bound state (pole below threshold, $E_B > 0$)