

Charged Lepton Flavor Violation at e^+e^- experiments

Swagato Banerjee



DPF 2024

APS | DIVISION OF PARTICLES & FIELDS

**H
E
N
O**

Latest topics in particle physics
and related issues in
astrophysics and cosmology

May 13-17, 2024
University of Pittsburgh / Carnegie Mellon University
Pittsburgh, PA, USA
indico.cern.ch/e/dpfpheno24



Charged Lepton Flavor Violation (cLFV)

cLFV does not mean LFV via ν mixing, which is too small to be seen

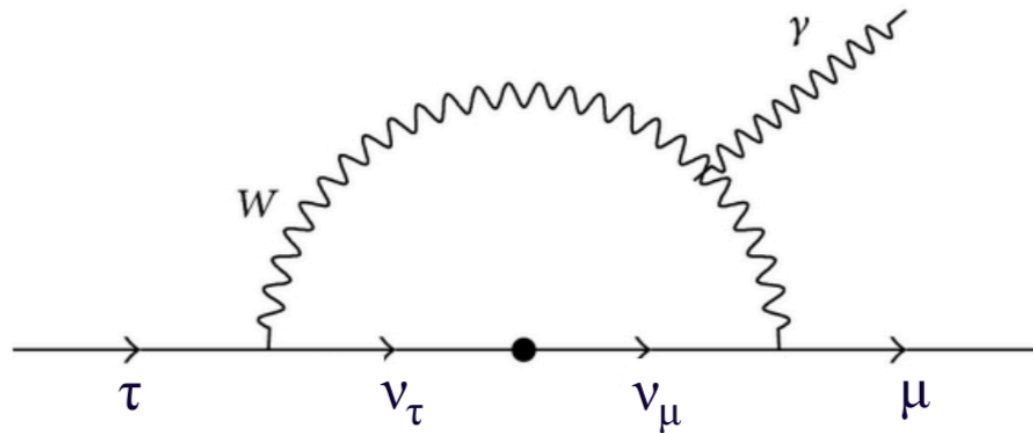

$$\mathcal{B}(\tau^\pm \rightarrow \mu^\pm \gamma) \quad \text{Lee \& Shrock: Phys.Rev.D 16 (1977) 1444}$$

$$= \frac{3\alpha}{128\pi} \left(\frac{\Delta m_{23}^2}{M_W^2} \right)^2 \sin^2 2\theta_{\text{mix}} \mathcal{B}(\tau \rightarrow \mu \bar{\nu}_\mu \nu_\tau)$$

$$\text{With } \Delta \sim 10^{-3} \text{ eV}^2, M_W \sim \mathcal{O}(10^{11}) \text{ eV} \\ \approx \mathcal{O}(10^{-54}) \quad (\theta_{\text{mix}} : \text{max})$$

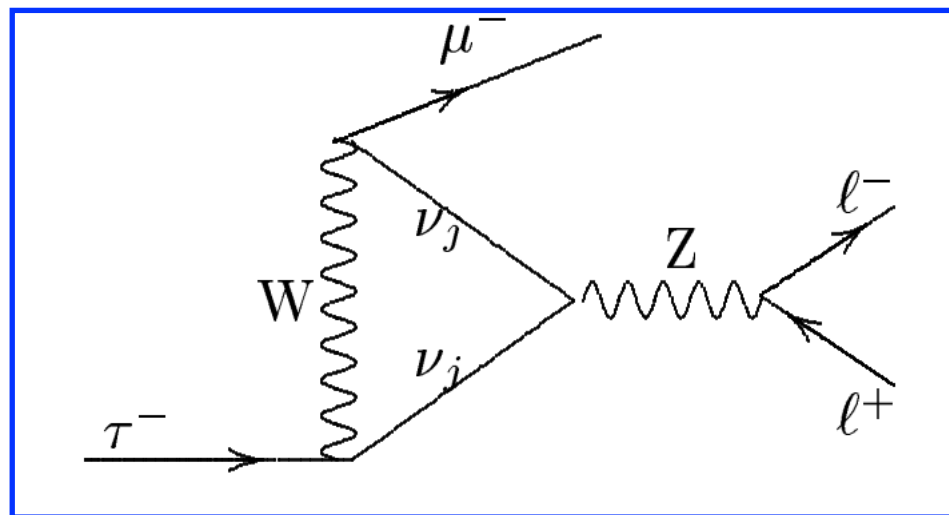

X.Y. Pham: [Eur.Phys.J.C8:513-516,1999](#)

$$\mathcal{B}(\tau^\pm \rightarrow \mu^\pm \ell^+ \ell^-) \simeq 10^{-14} \quad \otimes$$

P. Blackstone, M. Fael, E. Passemar : [Eur.Phys.J.C 80 \(2020\) 6, 506](#)

G. Hernández-Tomé, G. López Castro, P. Roig: [Eur.Phys.J.C 79 \(2019\) 1, 84, Eur.Phys.J.C 80 \(2020\) 5, 438 \(erratum\)](#)

$$\mathcal{B}(\tau^\pm \rightarrow \mu^\pm \ell^+ \ell^-) \leq 10^{-54} \quad \checkmark$$

Defining total lepton number $L \equiv L_e + L_\mu + L_\tau$, the global symmetry

$$U(1)_B \times U(1)_{L_e} \times U(1)_{L_\mu} \times U(1)_{L_\tau} = U(1)_{B+L} \times U(1)_{B-L} \times U(1)_{L_\mu-L_\tau} \times U(1)_{L_\mu+L_\tau-2L_e}$$

cLFV conserves L and B but violates $U(1)_{L_\mu-L_\tau} \times U(1)_{L_\mu+L_\tau-2L_e}$

\Rightarrow nice classification of all cLFV processes

J. Heeck: [Phys. Rev. D 95, 015022 \(2017\)](#)

LFV in τ vs μ sector

LFV in tau sector is complementary to muon sector in NP parameter space:
current limit on $\mathcal{B}(\mu \rightarrow e\gamma) \sim 10^{-13}$ does not forbid $\mathcal{B}(\tau \rightarrow \ell\gamma) \sim 10^{-8}$

Leptonic MFV: $\text{BR}(\mu \rightarrow e\gamma) / \text{BR}(\tau \rightarrow \mu\gamma) \sim s_{13}^2 \sim 10^{-2}$
 GUT models: $\text{BR}(\mu \rightarrow e\gamma) / \text{BR}(\tau \rightarrow \mu\gamma) \sim |V_{us}|^6 \sim 10^{-4}$

Vincenzo Cirigliano, Benjamin Grinstein, Gino Isidori, Mark B. Wise: [hep-ph/0507001](https://arxiv.org/abs/hep-ph/0507001) [hep-ph], [hep-ph/0608123](https://arxiv.org/abs/hep-ph/0608123) [hep-ph]
 R. Barbieri, L. Hall, A. Strumia: [hep-ph/9501334](https://arxiv.org/abs/hep-ph/9501334) [hep-ph]

● Mass dependent couplings enhance tau LFV w.r.t. lighter leptons

$$\lambda_{ab} \sim (y_a^l y_b^l)^{-1}$$

$$\lambda_{ab} = \lambda \begin{pmatrix} \pm 1 & \nu^2 & \nu^3 \\ \nu^2 & \nu^4 & \nu^5 \\ \nu^3 & \nu^5 & \nu^6 \end{pmatrix}$$

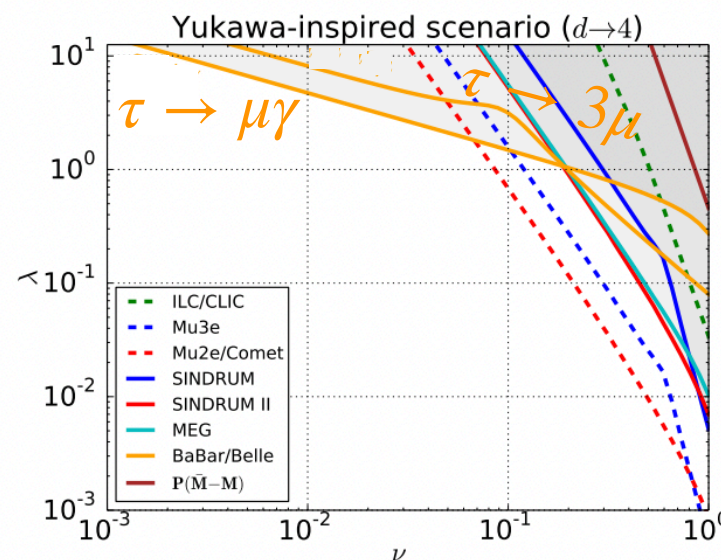
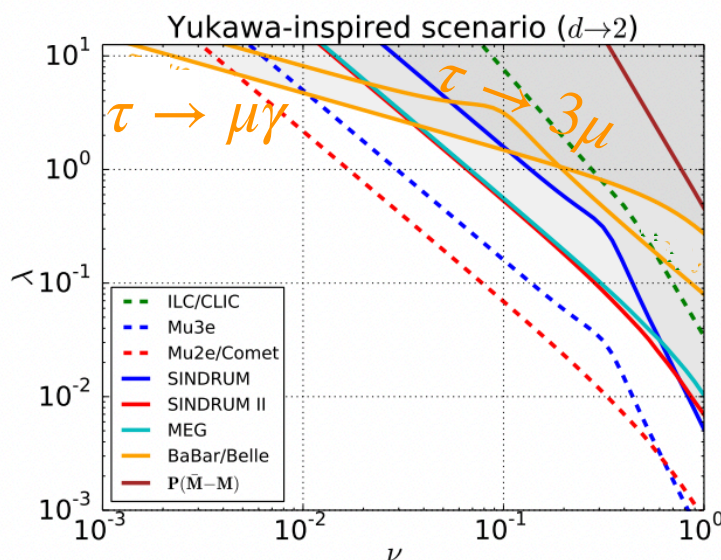

Low- and high-energy phenomenology of a doubly charged scalar

A. Crivellin et. al.
Phys. Rev. D **99**,
 035004 (2019)

[arXiv:1807.10224](https://arxiv.org/abs/1807.10224) [hep-ph]

Some of LFV processes probed in e^+e^- experiments

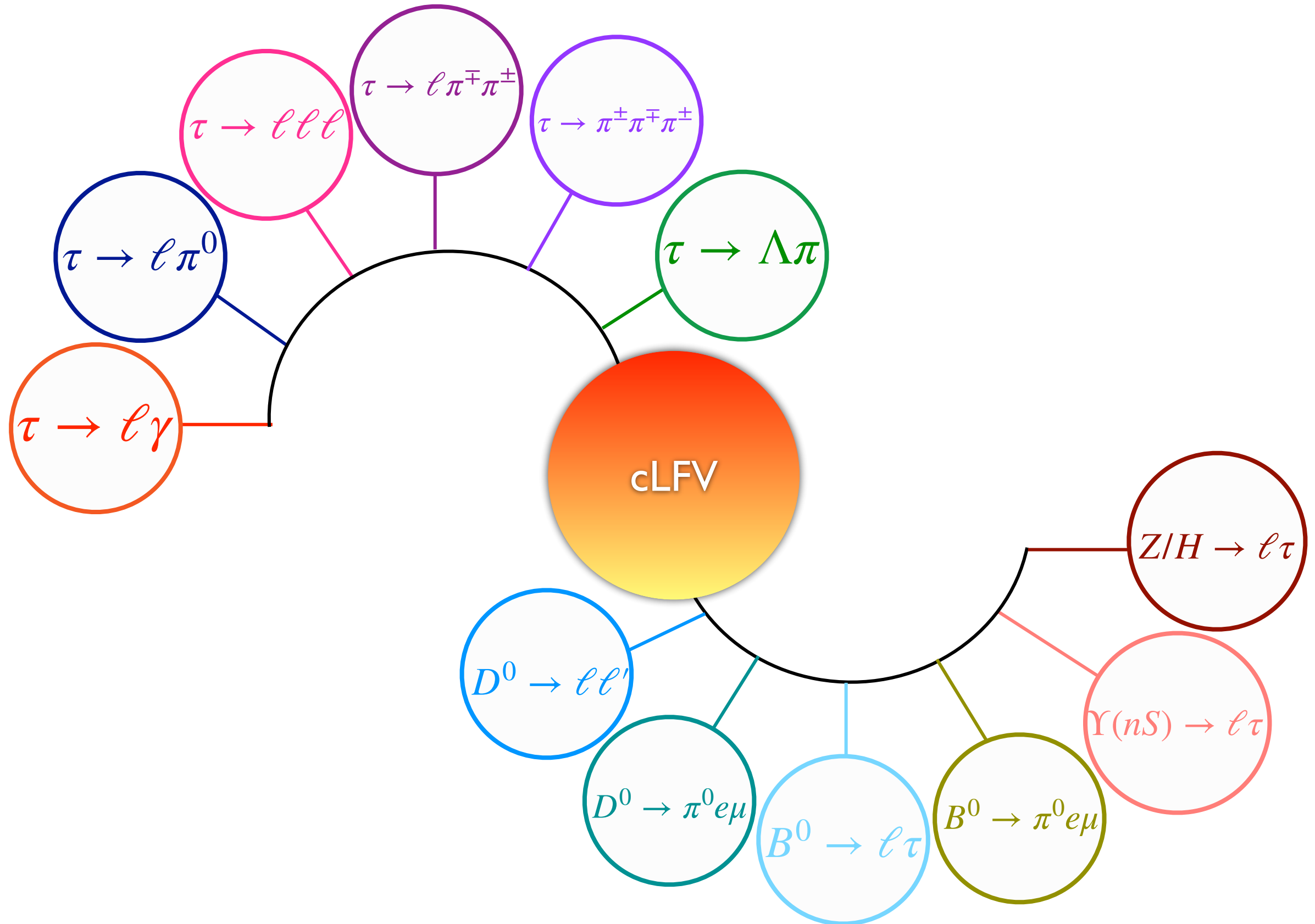

About 50 τ decay modes & many transitions with τ in final state

- **Lepton flavor violation (charge conjugate modes implied)**

- $\tau \rightarrow e/\mu \gamma$ (BaBar, Belle (II), STCF, FCC-ee)
- $\tau \rightarrow e/\mu$ (scalar/pseudoscalar/vector mesons) (BaBar, Belle II)
- $\tau \rightarrow e e e$ (BaBar, Belle II)
- $\tau \rightarrow \mu \mu \mu$ (BaBar, Belle II, STCF, FCC-ee)
- $\tau \rightarrow e \mu \mu, \mu e e$ (BaBar, Belle II)
- $\tau \rightarrow e/\mu h h$ (non-resonant states with $h=\pi/K$) (BaBar, Belle (II), STCF)
- $\tau \rightarrow e/\mu$ invisible (α) (Belle II)
- $B/D/\Upsilon(nS) \rightarrow e \tau, \mu \tau$ (BaBar, Belle (II), LEP, FCC-ee)
- $B/D \rightarrow e \tau h, \mu \tau h$ (where $h=\pi/K$) (BaBar, Belle II)
- $H/Z/Z' \rightarrow e \tau, \mu \tau$ (FCC-ee)

- **Lepton number violation**

- $\tau^- \rightarrow e^+ h^- h^-$ (non-resonant final states with $h=\pi/K$) (BaBar, Belle (II))
- $\tau^- \rightarrow \mu^+ h^- h^-$ (non-resonant final states with $h=\pi/K$) (BaBar, Belle (II))

- **Baryon number violation**

- $\tau^- \rightarrow \Lambda \pi^-, \bar{\Lambda} \pi^-$ (Belle II)
- $\tau^- \rightarrow \bar{p} \mu^+ \mu^-, p \mu^- \mu^-$ (Belle)
- $D^0 \rightarrow e^-/\mu^- p$ (Belle)
- $B^- \rightarrow e^-/\mu^- \Lambda$ (BaBar)



New Physics illustrations for LFV in τ decays

Tree level:

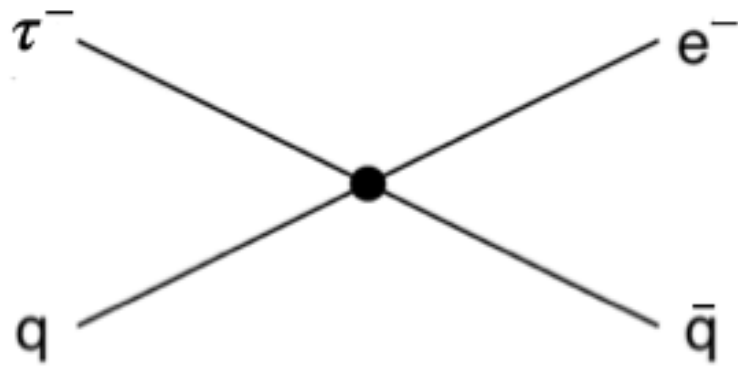

Compositeness

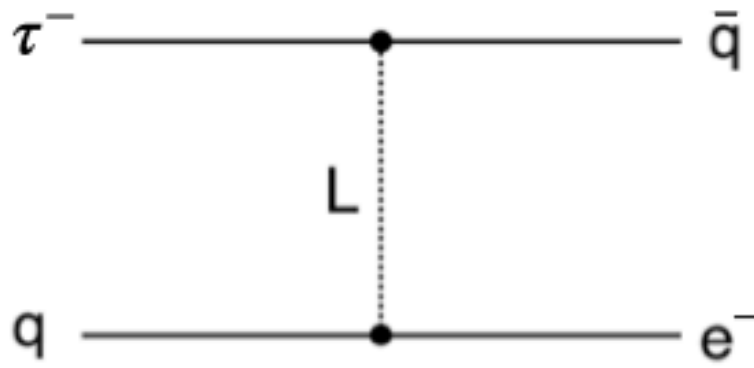

Leptoquarks

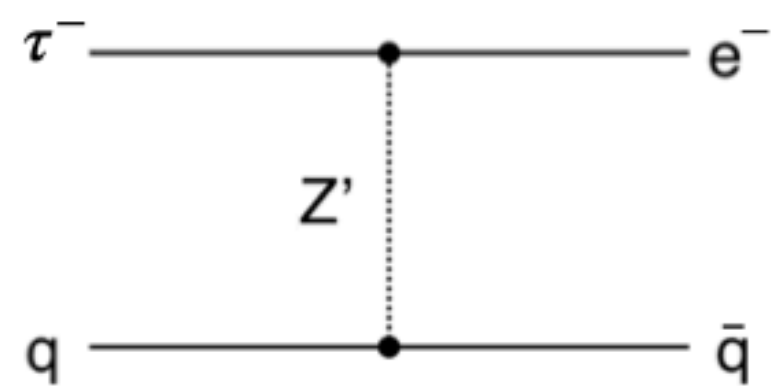

Heavy gauge bosons

Loop induced:

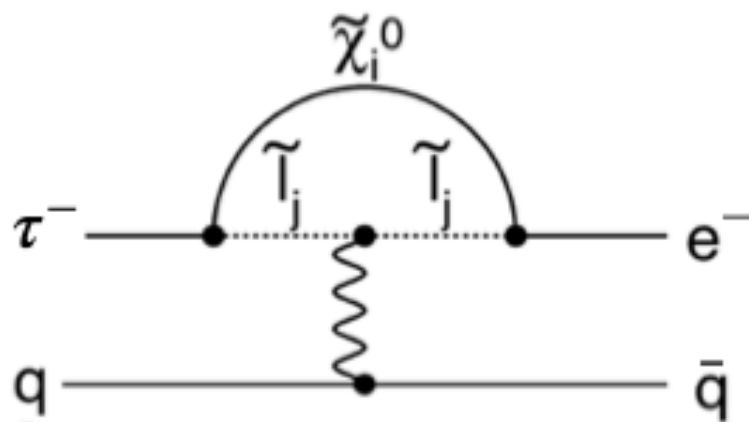

Supersymmetry

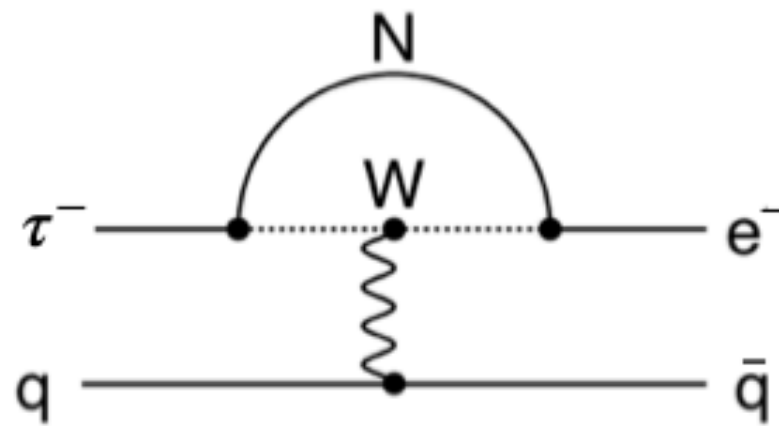

Heavy neutrinos

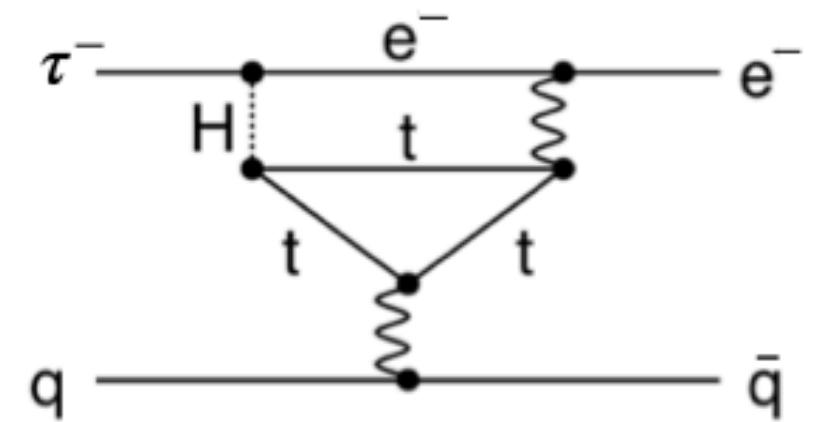

Extended Higgs models

- Expected rates from New Physics are slightly less than current experimental bounds.

Illustrative Scenarios for LFV in decays b mesons

- **Suppressed Standard Model contributions**

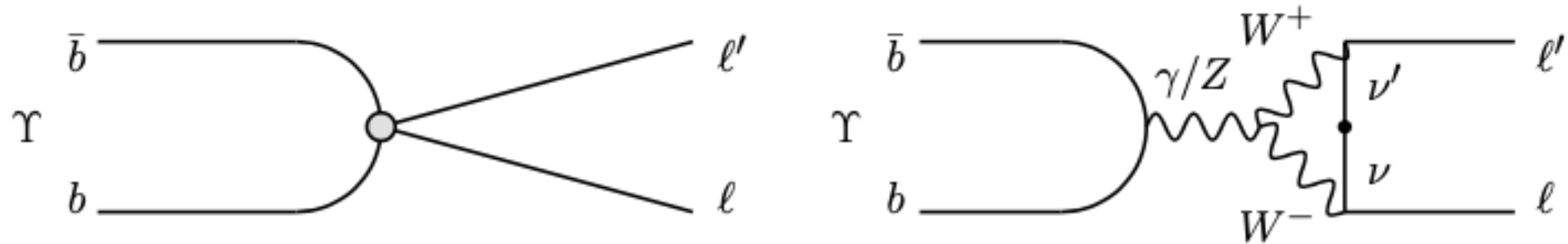

- **New Physics scenarios**

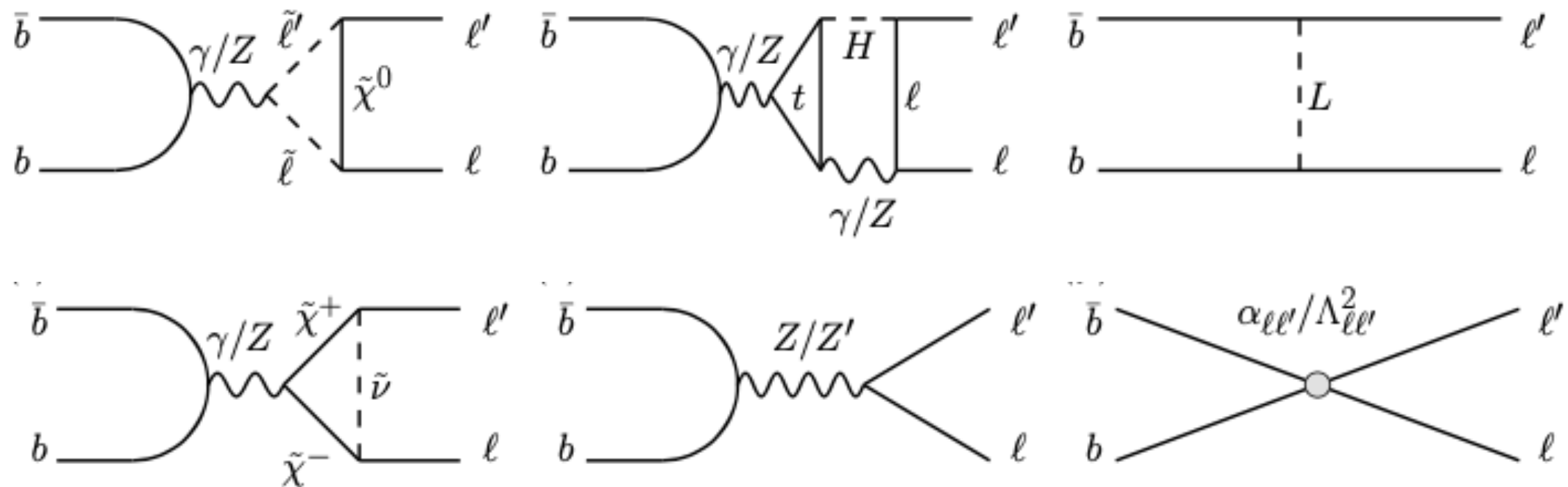

- **Expected rates from New Physics are slightly less than current experimental bounds.**

Salient features of LFV in τ decays from e^+e^- colliders

$$e^+e^- \rightarrow \tau^+\tau^-$$

- Known initial conditions (beam energy constraint)
- Clean environment (fewer backgrounds)

Two independent variables:

$$M_\tau = \sqrt{E_{\mu\mu\mu}^2 - P_{\mu\mu\mu}^2}$$

$$\Delta E = E_{\mu\mu\mu}^{CMS} - E_{\text{beam}}^{CMS}$$

- ➔ ΔE close to 0 for signal
- ➔ Mass of tau daughters close to τ mass

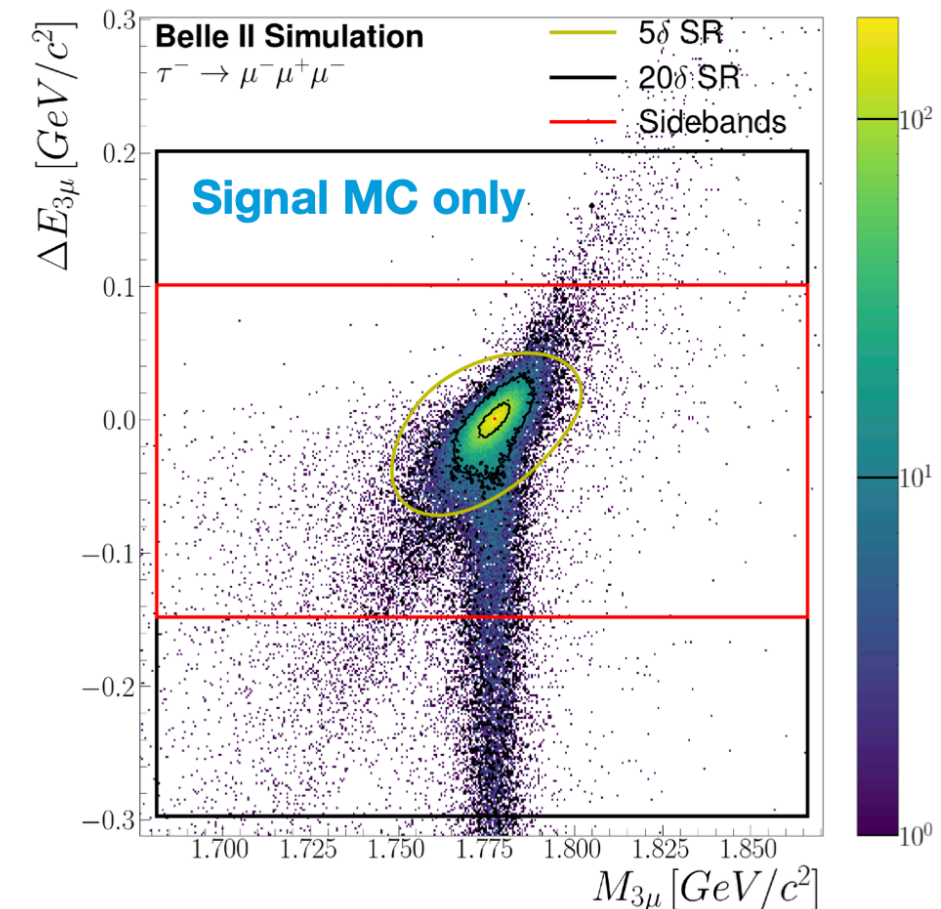

Higher signal efficiency is foreseen at Belle II than at Belle or BaBar

- improved vertex tracking / calorimetry / muon detectors
- momentum dependent particle identification optimizations
- inclusive tagging for tau-pair reconstruction, **Boosted Decision Trees**

$\tau \rightarrow \mu\mu\mu$ at B-Factories



BABAR

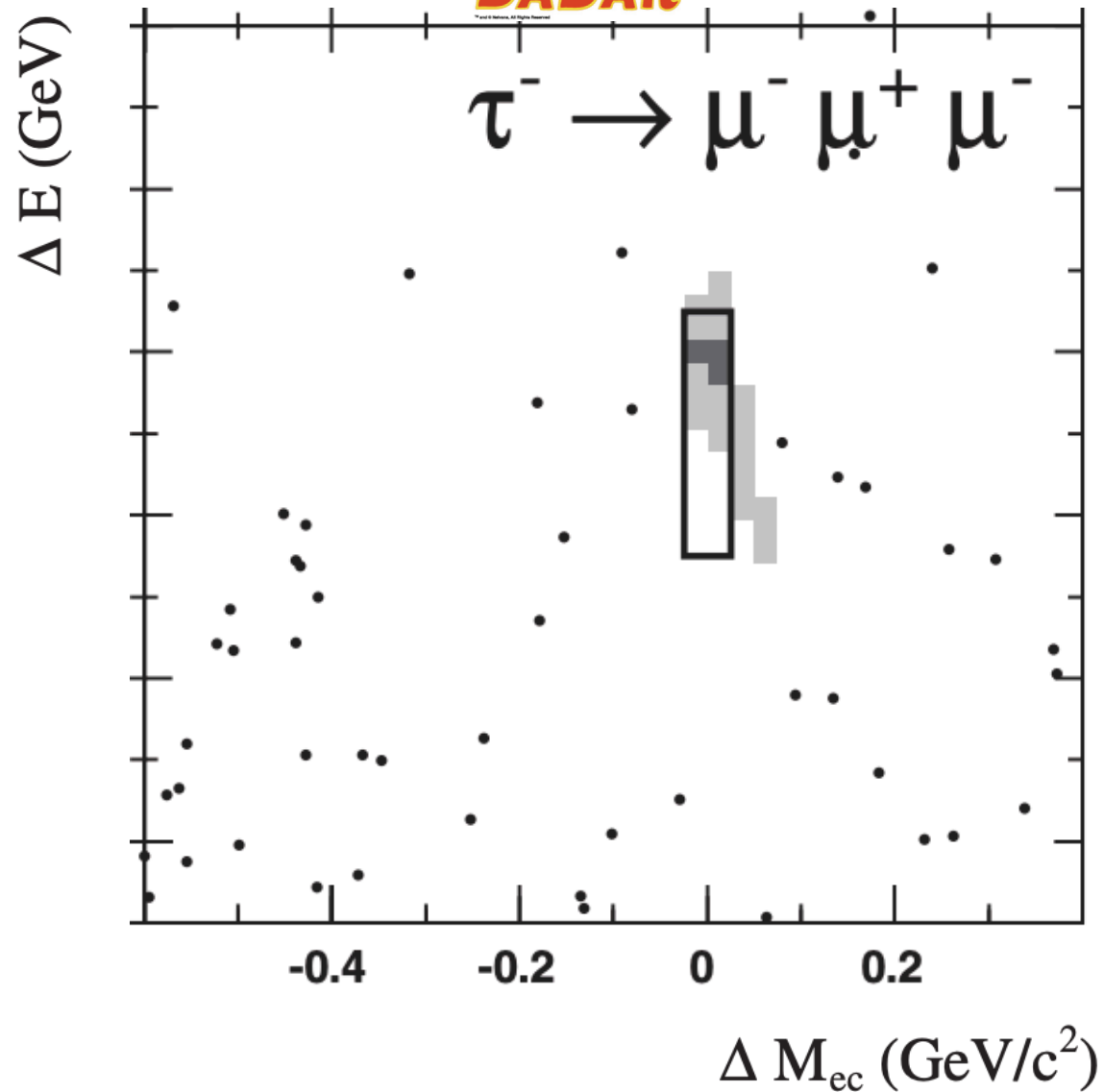

$\mathcal{B}(\tau \rightarrow \mu\mu\mu) < 3.3 \times 10^{-8}$ at 90% C.L. with 468 fb⁻¹

Phys.Rev.D 81 (2010) 111101

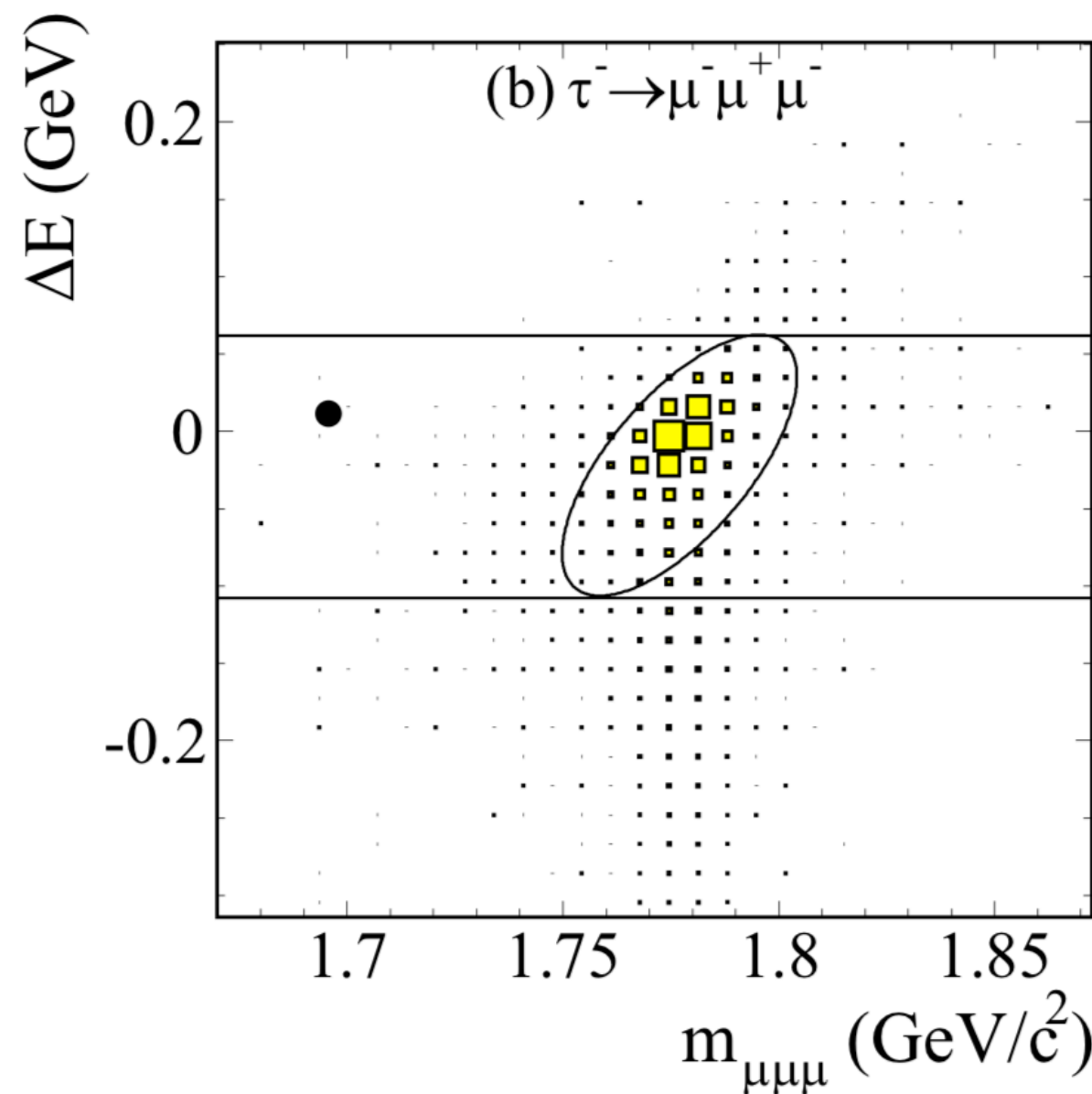

$\mathcal{B}(\tau \rightarrow \mu\mu\mu) < 2.1 \times 10^{-8}$ at 90% C.L. with 782 fb⁻¹

Phys. Lett. B687 (2010) 139

$\tau \rightarrow \mu\mu\mu$ at B-Factories

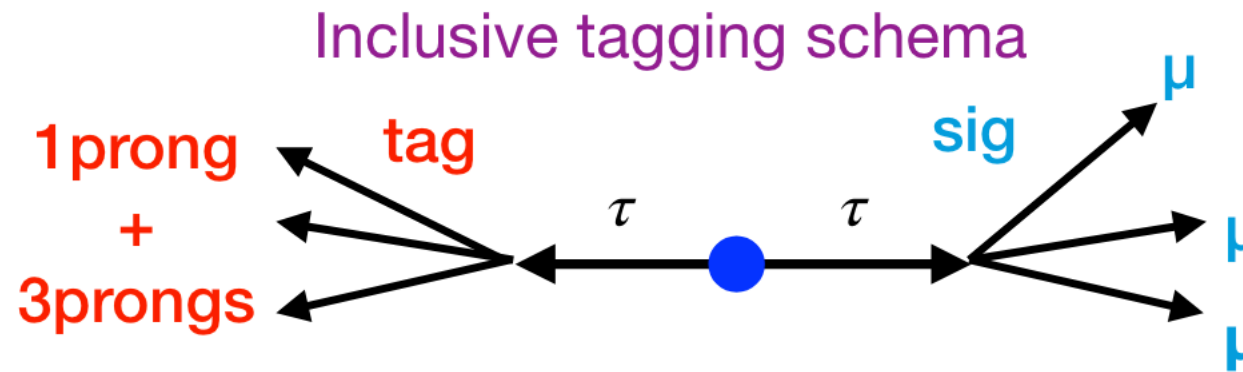

$\epsilon_{\text{sig}} = 20.42 \pm 0.06\%$ ~3x larger than Belle & Expected BKG: $0.5^{+1.4}_{-0.5}$ events

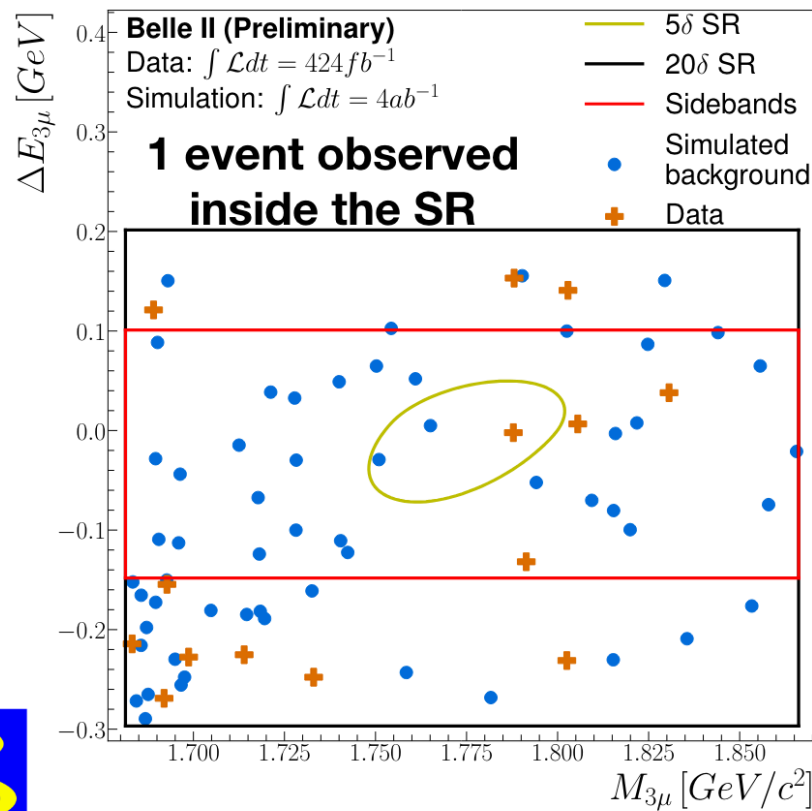

No significant excess in 424 fb⁻¹ of data → 90% C.L. upper limits using the CL_s method

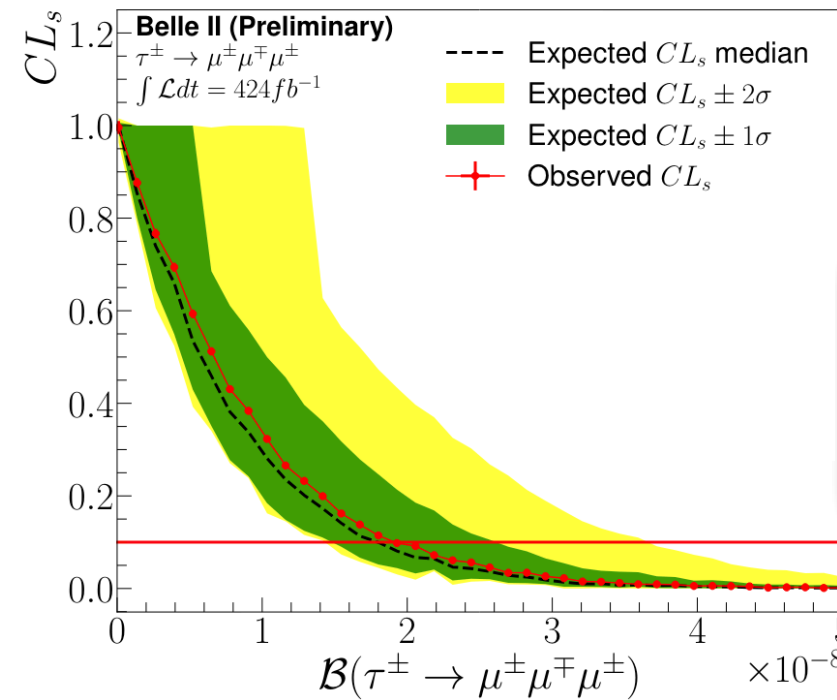

Dominant syst. from lepton ID efficiency
 Negligible impact on the limit

Obtained most stringent limit
 1.9×10^{-8}

17th International Workshop on τ Lepton Physics: τ 2023 - Alberto Martini for Belle II - 5 December 2023, Louisville Kentucky USA

17

CMS: $\mathcal{B}(\tau \rightarrow \mu\mu\mu) < 2.9 \times 10^{-8}$ at 90% C.L. with 131 fb⁻¹

LHCb: $\mathcal{B}(\tau \rightarrow \mu\mu\mu) < 4.6 \times 10^{-8}$ at 90% C.L. with 3 fb⁻¹

Phys.Rev.D 81 (2010) 111101 arXiv:2312.02371 [hep-ex]

JHEP 02 (2015) 121 arXiv:1409.8548 [hep-ex]

$\tau \rightarrow \ell \alpha$ at Belle II

- LFV decay: $\tau \rightarrow \ell \alpha$ (where $\ell = e$ or μ , and α is an invisible boson)
- α can enter from new physics models, eg. light axion like particles (ALP), Z' , etc.

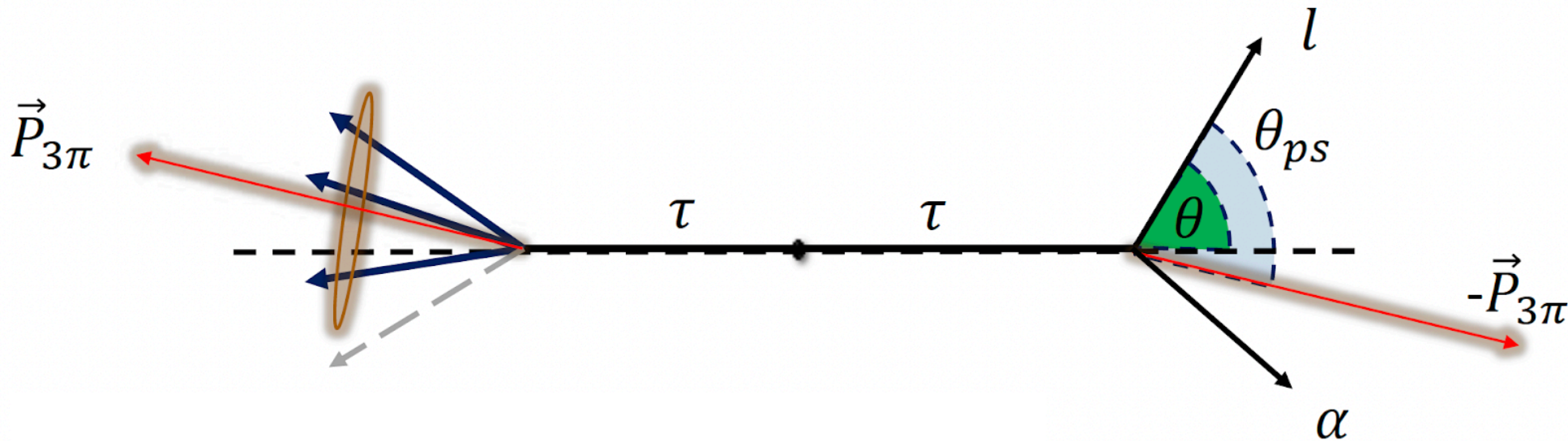

τ pseudo-rest frame

2-body $\tau \rightarrow \ell \alpha$ decay will appear as a bump against the SM 3-body $\tau \rightarrow \ell \nu \bar{\nu}$ background in the p_ℓ distribution in the τ pseudo-rest frame

$$\hat{p}_\tau \approx -\frac{\vec{p}_{3\pi}}{|\vec{p}_{3\pi}|}, \quad E_\tau \approx \sqrt{s}/2$$

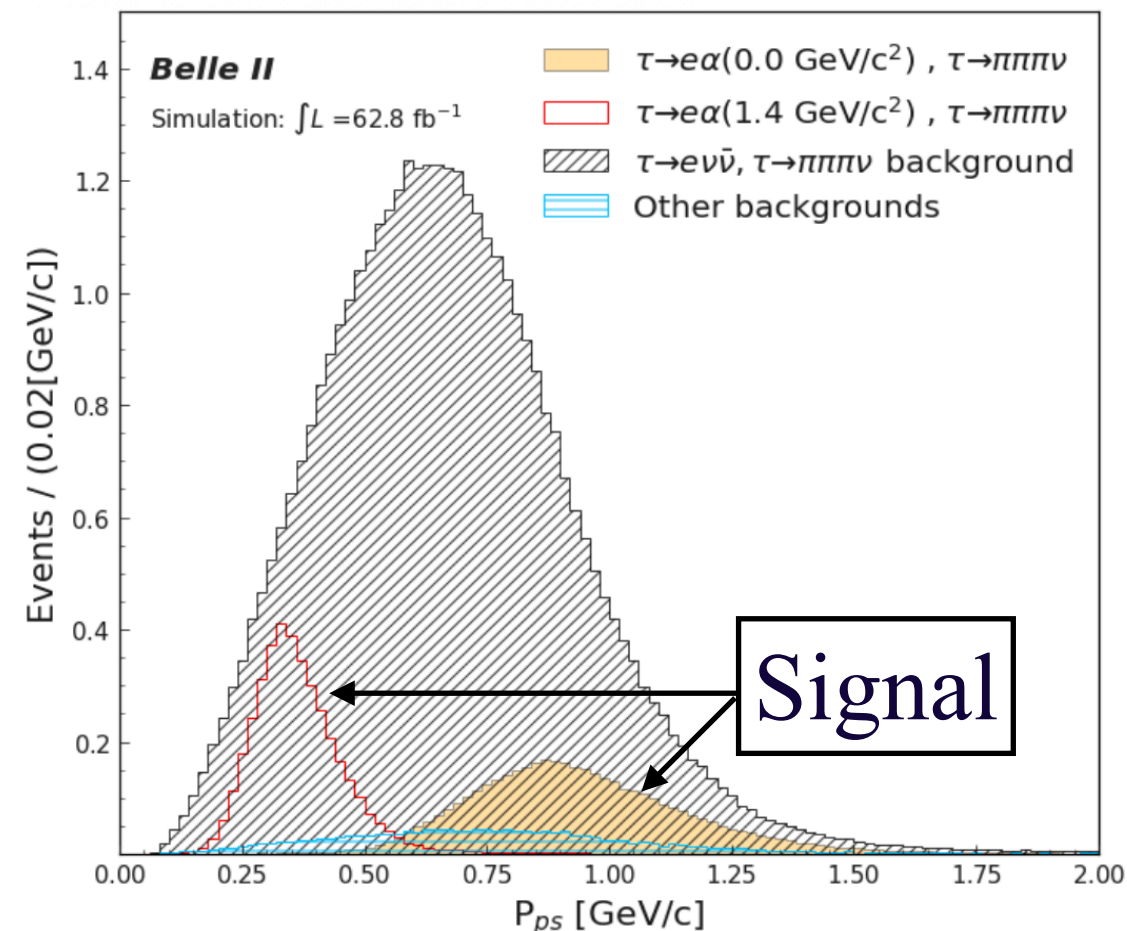

$\tau \rightarrow \ell \alpha$ at Belle II

95% C.L. upper limits from Belle II [arXiv:2212.03634, PRL 130, 181803 (2023)]

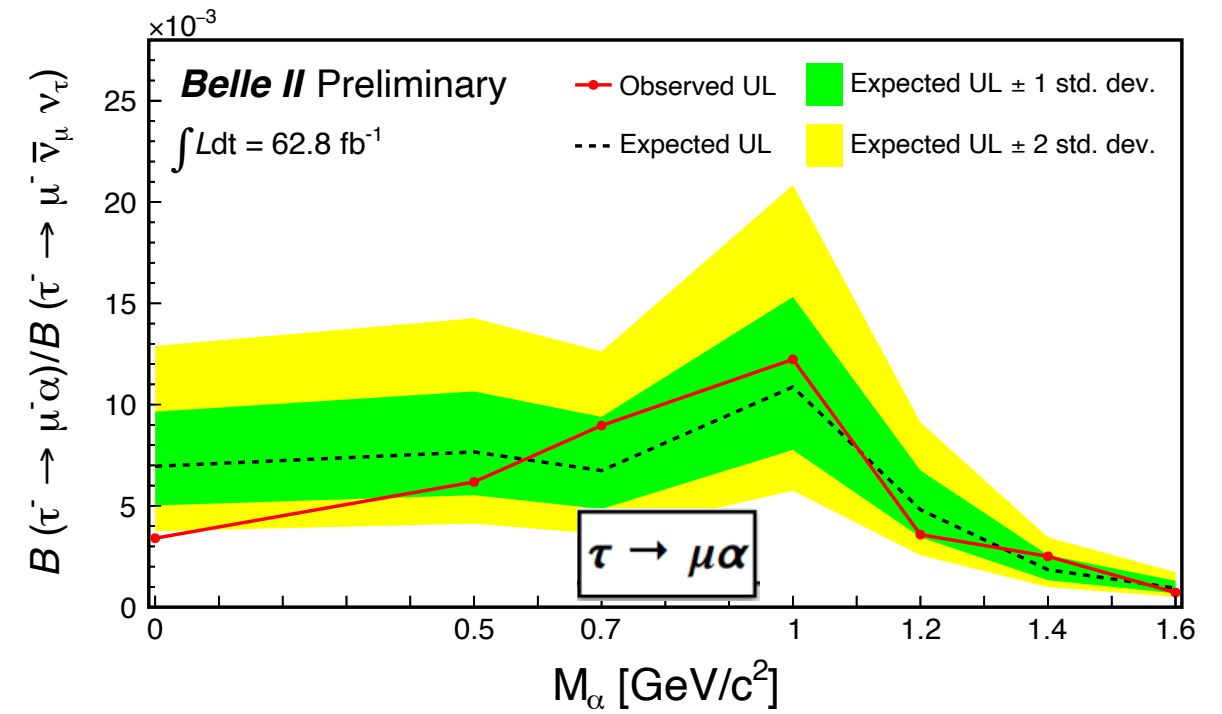
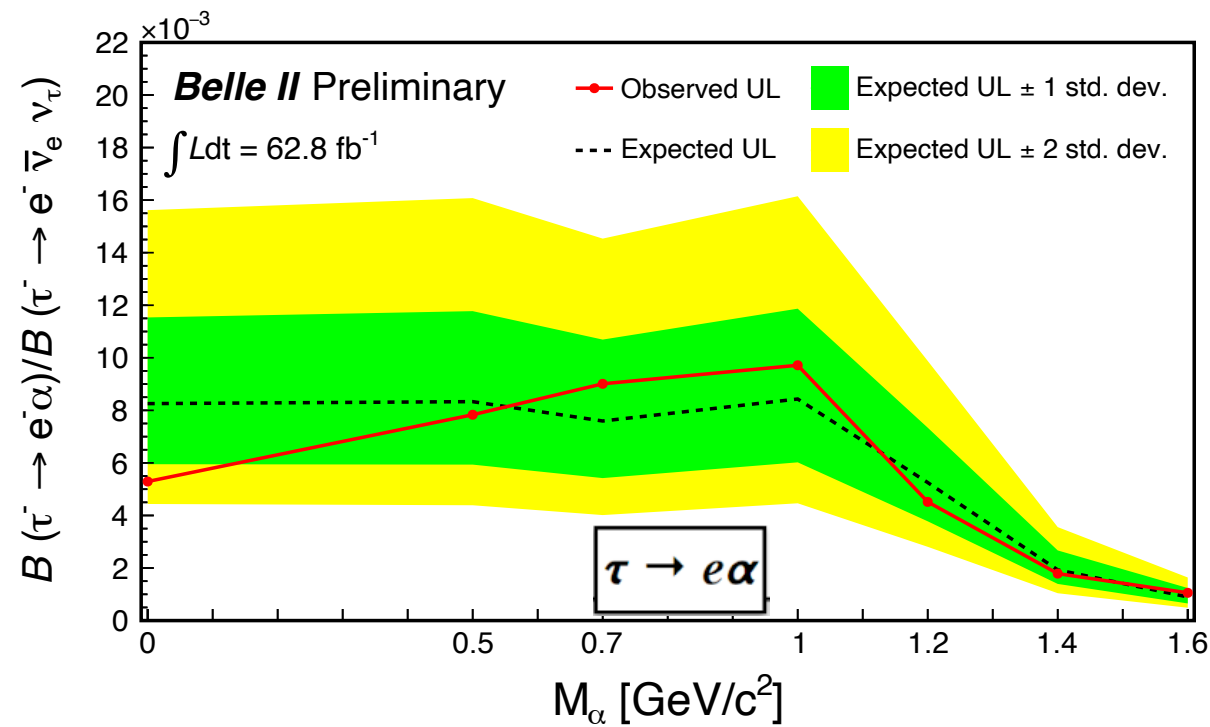

Comparison with previous limits from ARGUS (0.472 fb⁻¹) [Z. Phys. C68 (1995) 25]

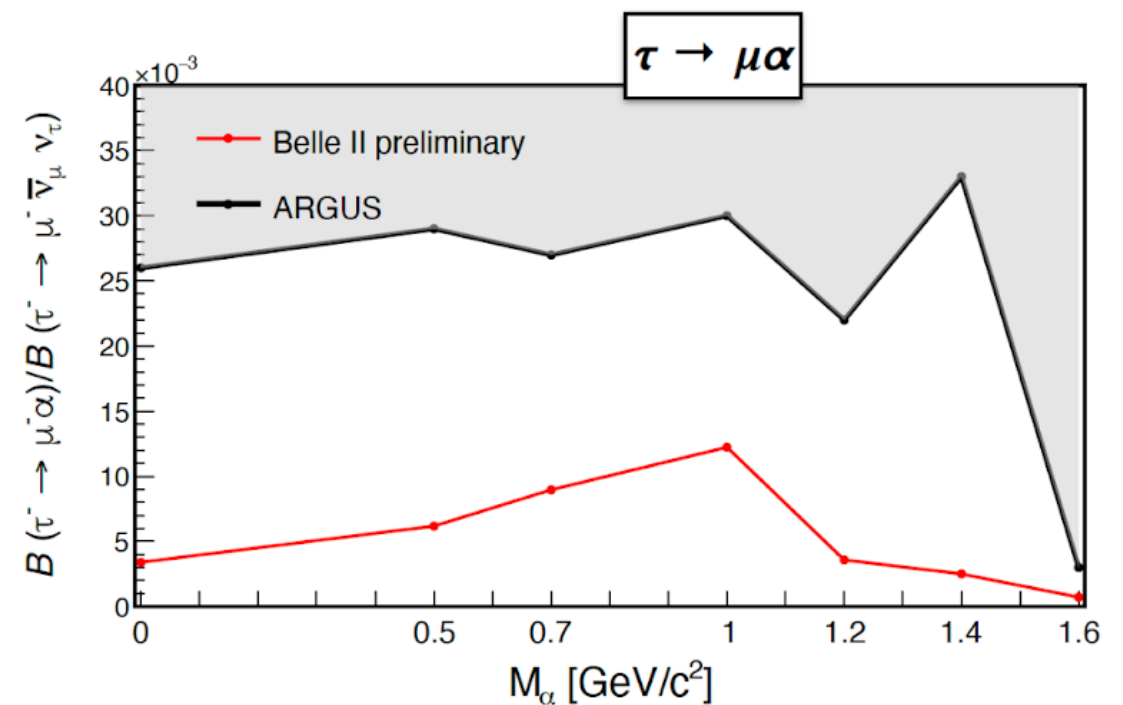
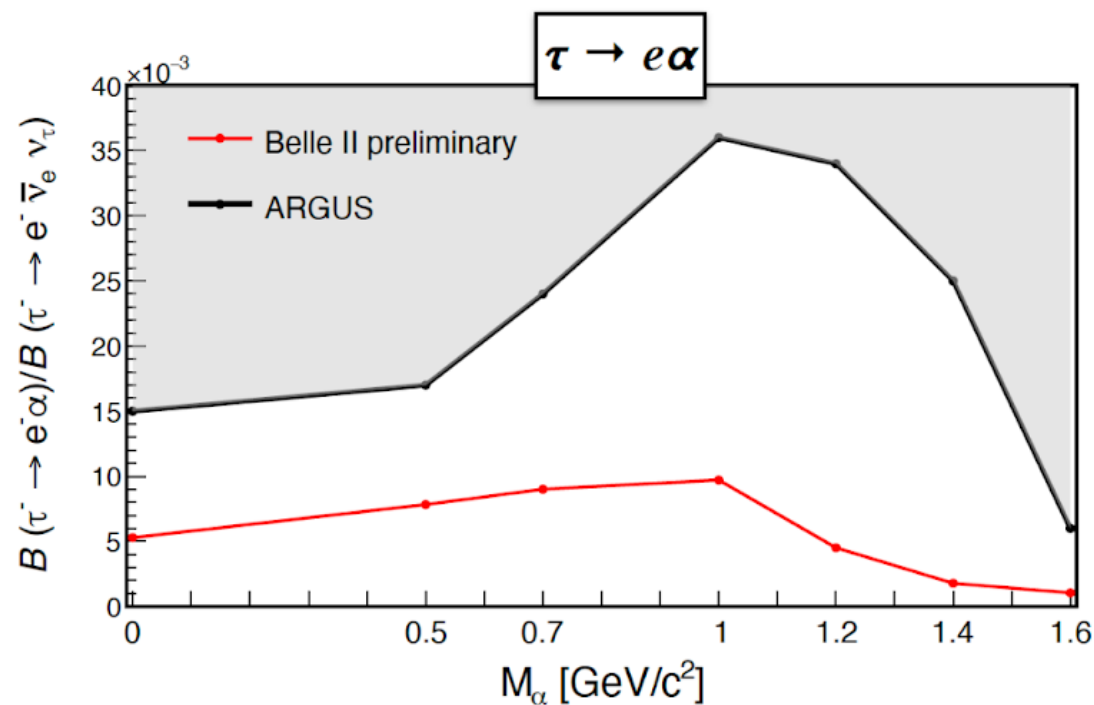

Estimates of experimental sensitivity in LFV searches

$$B_{UL}^{90} = N_{UL}^{90} / (N_{\tau} \times \epsilon)$$

- ϵ : high statistics signal MC simulated for different Data-taking periods

$\epsilon =$ Trigger . Reco . Topology . PID . Cuts . Signal-Box

90% 70% 70% 50% 50% 50%

Cumulative:

90% 63% 44% 22% 11% **~5%**

	\sqrt{s}	Luminosity (L)	$N_{\tau} = 2L\sigma$
BaBar	10.58 GeV	0.5 ab ⁻¹	9 x 10 ⁸
Belle	10.58 GeV	1 ab ⁻¹	2 x 10 ⁹
Belle II	10.58 GeV	50 ab ⁻¹	9 x 10 ¹⁰
STCF	2-7 GeV	1 ab ⁻¹	7 x 10 ⁹
FCC-ee	91.2 GeV	150 ab ⁻¹	3 x 10 ¹¹

Current status of LFV τ decays

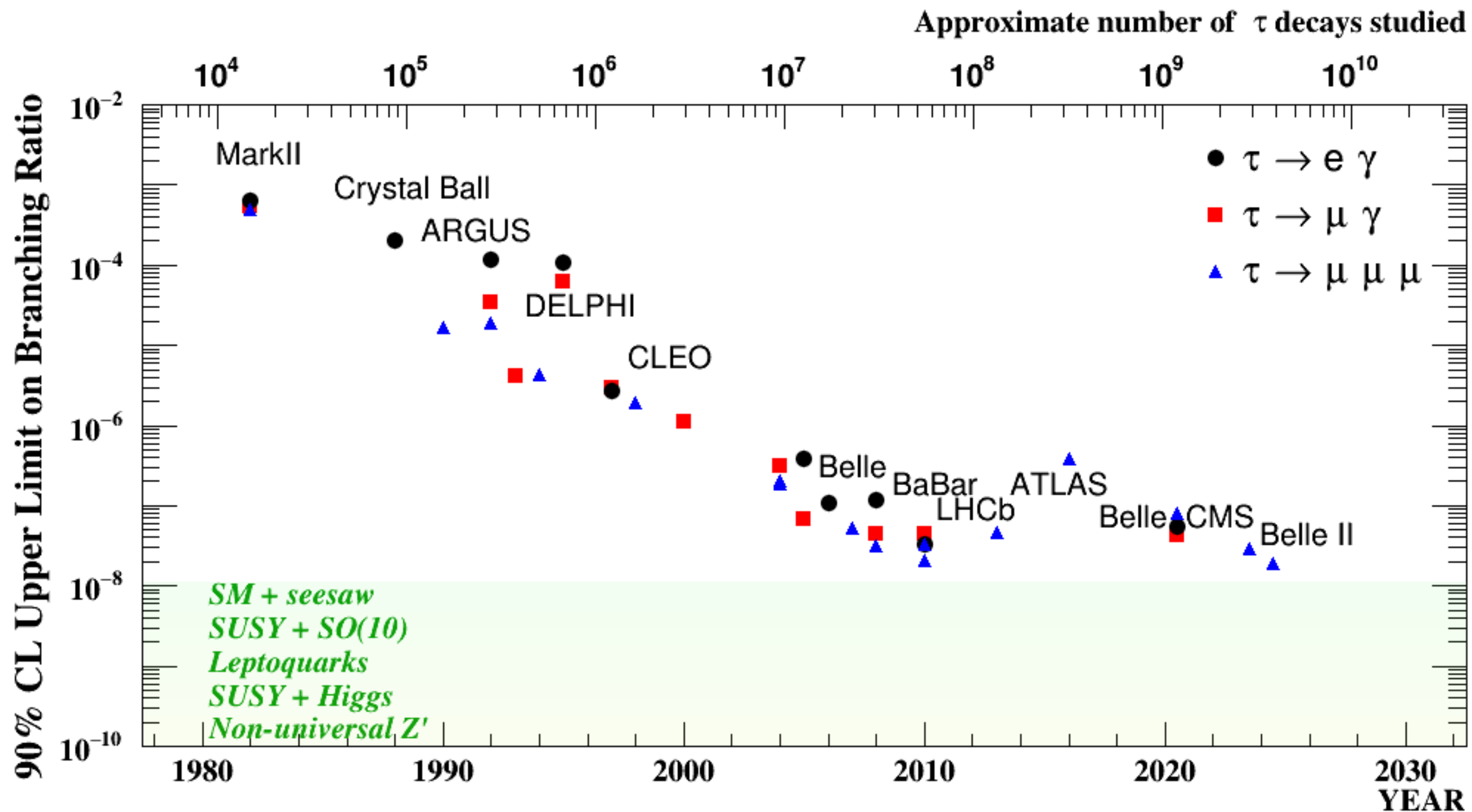

Projected limits at Belle II

	Background limited search $\tau \rightarrow \ell \gamma$	Background free search ($N_{bkg} < 1$) (all other LFV τ decays shown below)
N_{UL}^{90}	$\sqrt{\mathcal{L}}$	2.44 [Feldman – Cousins for $N_{obs} = 0$]
B_{UL}^{90}	$\propto 1/\sqrt{\mathcal{L}}$	$\propto 1/\mathcal{L}$

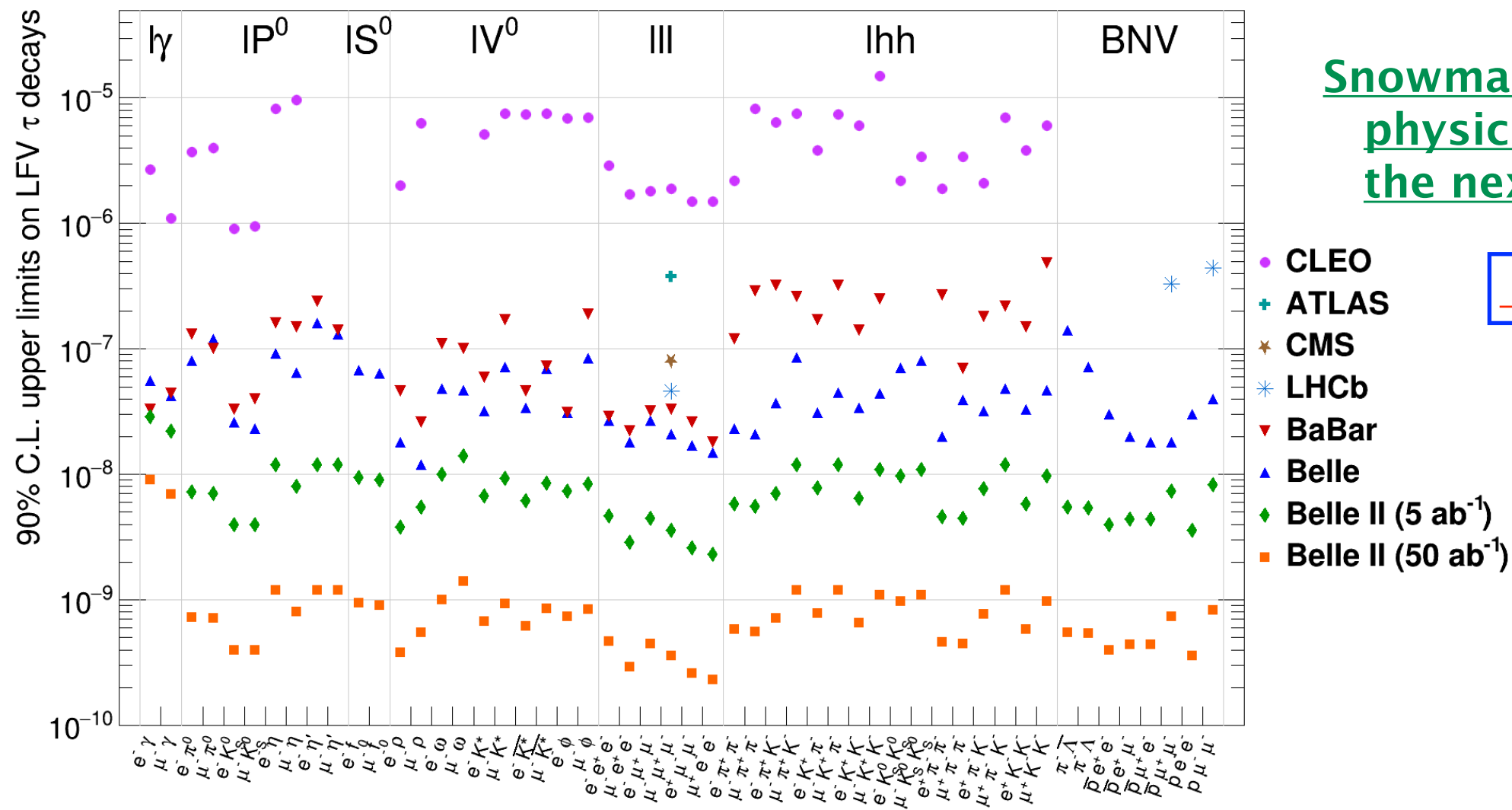

Snowmass White Paper: Belle II physics reach and plans for the next decade and beyond

[2207.06306 \[hep-ex\]](https://arxiv.org/abs/2207.06306)

Projections

Belle II to probe LFV in several channels $\approx \mathcal{O}(10^{-10})$ to $\mathcal{O}(10^{-9})$ with 50 ab⁻¹

Super Tau-Charm Facility

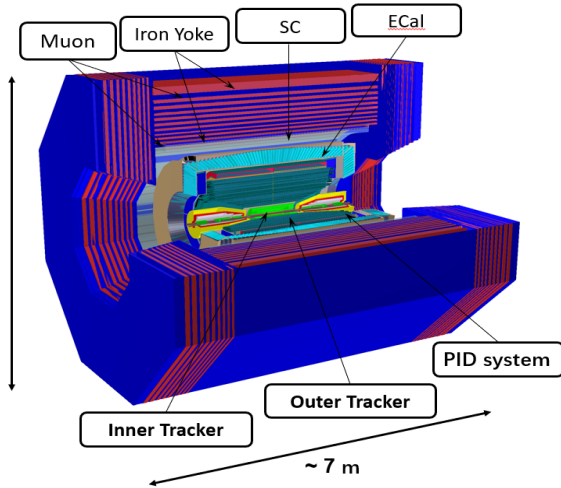

“Physics Potential of a Super tau-Charm Facility” (RF/SNOWMASS21-RF7 RF1 STCF-013.pdf)

- Peaking luminosity $>0.5 \times 10^{35} \text{ cm}^{-2}\text{s}^{-1}$ at 4 GeV
- Energy range $E_{\text{cm}} = 2\text{-}7 \text{ GeV}$
- Potential to increase luminosity and realize beam polarization
- A nature extension and a viable option for China accelerator project in the post BEPCII/BESIII era

PoS CHARM2020 (2021), 007
Physics 49 (2020) 8, 513-524

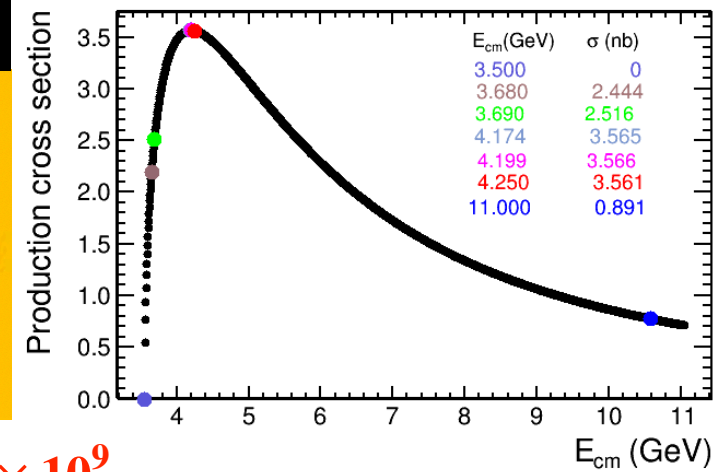

At 4.26 GeV, number of tau pairs per year: $N_{\tau\tau} \sim 1.0 \text{ ab}^{-1} \times 3.5 \text{ nb} = 3.5 \times 10^9$

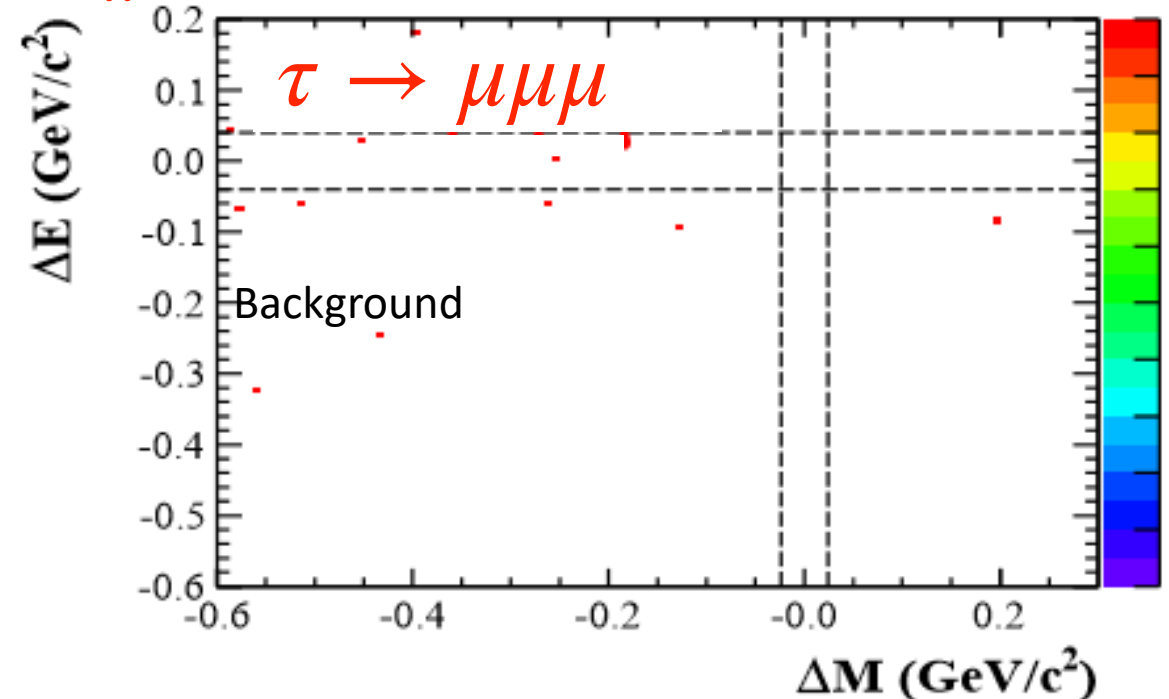
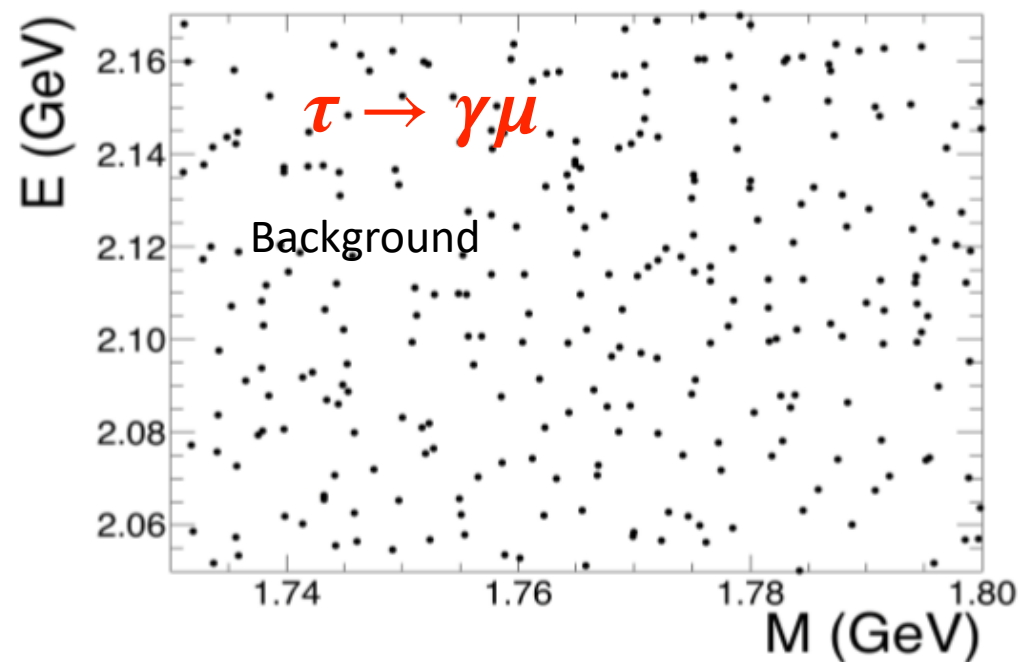

➤ STCF with 1 ab^{-1} :

$$\mathcal{B}_{UL}^{90}(\tau \rightarrow \gamma\mu) < \frac{N_{UL}^{90}}{2\epsilon N_{\tau\tau}} \sim 2.8 \times 10^{-8}$$

➤ STCF with 1 ab^{-1} :

$$\mathcal{B}_{UL}^{90}(\tau \rightarrow \mu\mu\mu) < \frac{N_{UL}^{90}}{2\epsilon N_{\tau\tau}} \sim 1.4 \times 10^{-9}$$

With 10 ab^{-1} : $\mathcal{B}^{90}(\tau \rightarrow \gamma\mu) < 8.8 \times 10^{-9}$

Teng Xiang, Xiao-Dong Shi, Da-Yong Wang, Xiao-Rong Zhou
Eur.Phys.J.C 83 (2023) 10, 908 arXiv: 2305.00483 [hep-ex]



$$\mathcal{B}(\tau \rightarrow \mu\gamma)$$

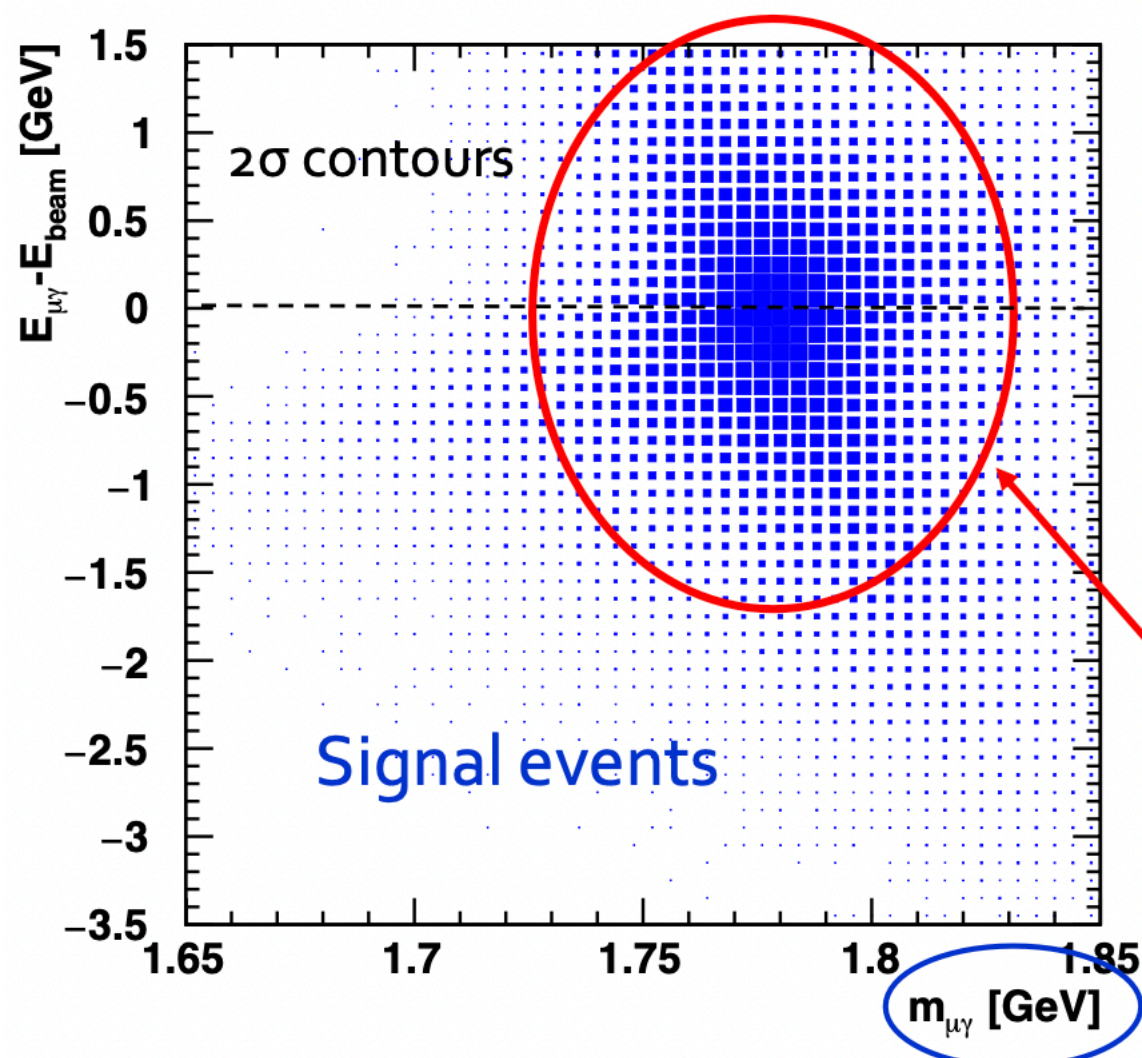

- ◆ **Main background:** Radiative events (IRS+FSR), $e^+e^- \rightarrow \tau^+\tau^-\gamma$
- $\tau \rightarrow \mu\gamma$ decay faked by combination of γ from ISR/FSR and μ from $\tau \rightarrow \mu\nu\bar{\nu}$

Smear with assumed FCC-ee detector resolutions (ILC-like detector):

- Muon momentum [GeV]
 $\sigma(p_T)/p_T = 2 \times 10^{-5} \times p_T \oplus 1 \times 10^{-3}$
- Photon ECAL energy [GeV]
 $\sigma(E)/E = 0.165/\sqrt{E} \oplus 0.010/E \oplus 0.011$
- Photon ECAL spatial [mm]
 $\sigma(x) = \sigma(y) = (6/E \oplus 2) \text{ mm}$

$$\sigma(m_{\gamma\mu}) = 26 \text{ MeV}; \quad \sigma(E_{\gamma\mu}) = 850 \text{ MeV}$$

- From study (assuming 25% signal & background efficiency), projected BR sensitivity **2×10^{-9}**
- Expect this search to have *very low* background, even with FCC-ee like statistics
- Should be able to have sensitivity down to BRs of $\mathcal{B}(\tau \rightarrow \mu\mu\mu) \simeq 10^{-10}$

Mogens Dam, arXiv: 1811.09408 [hep-ex]

Summary of experimental prospects of τ decays

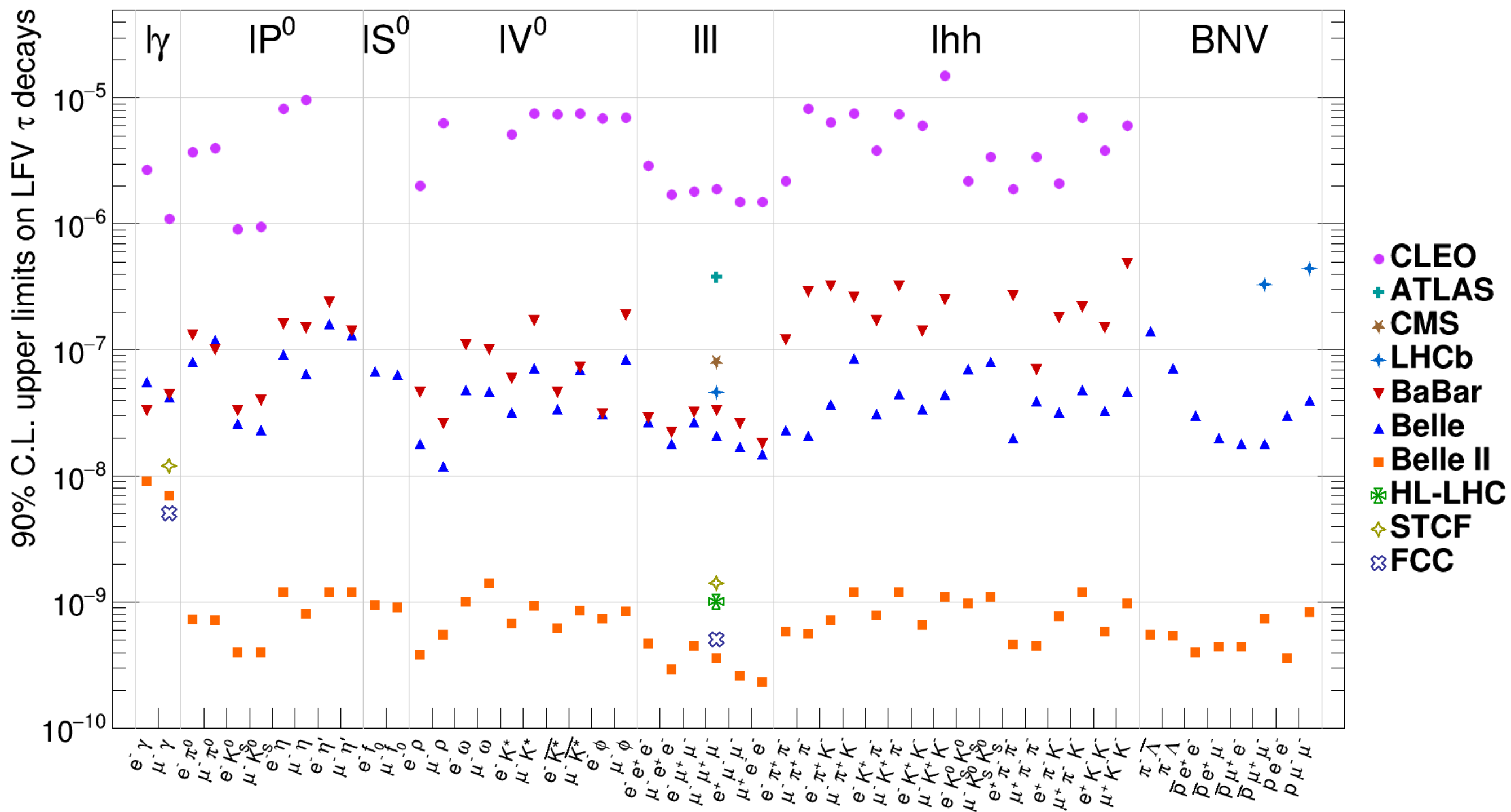

Snowmass 2021: cLFV in τ sector [e-Print: 2203.14919 \[hep-ph\]](https://arxiv.org/abs/2203.14919)

Summary of transitions with τ in the final state

Channel	Upper limit at 90% C.L.	Experiment [Reference]
$D^0 \rightarrow e^\pm \mu^\mp$	3.3×10^{-7}	BABAR [Phys.Rev.D 86 (2012) 032001]
$D^0 \rightarrow pe^-$	5.5×10^{-7}	Belle [Phys.Rev.D 109 (2024) 3, L031101]
$\bar{D}^0 \rightarrow pe^-$	6.9×10^{-7}	Belle [Phys.Rev.D 109 (2024) 3, L031101]
$D^0 \rightarrow \bar{p}e^+$	7.2×10^{-7}	Belle [Phys.Rev.D 109 (2024) 3, L031101]
$\bar{D}^0 \rightarrow \bar{p}e^+$	7.6×10^{-7}	Belle [Phys.Rev.D 109 (2024) 3, L031101]
$D^0 \rightarrow p\mu^-$	5.1×10^{-7}	Belle [Phys.Rev.D 109 (2024) 3, L031101]
$\bar{D}^0 \rightarrow p\mu^-$	6.5×10^{-7}	Belle [Phys.Rev.D 109 (2024) 3, L031101]
$D^0 \rightarrow \bar{p}\mu^+$	6.3×10^{-7}	Belle [Phys.Rev.D 109 (2024) 3, L031101]
$\bar{D}^0 \rightarrow \bar{p}\mu^+$	6.5×10^{-7}	Belle [Phys.Rev.D 109 (2024) 3, L031101]
$D^0 \rightarrow \pi^0 e^\pm \mu^\mp$	8.0×10^{-7}	BABAR [Phys.Rev.D 101 (2020) 11, 112003]
$D^0 \rightarrow \rho^0 e^\pm \mu^\mp$	5.0×10^{-7}	BABAR [Phys.Rev.D 101 (2020) 11, 112003]
$D^0 \rightarrow \phi e^\pm \mu^\mp$	5.1×10^{-7}	BABAR [Phys.Rev.D 101 (2020) 11, 112003]
$D^0 \rightarrow K_S^0 e^\pm \mu^\mp$	8.6×10^{-7}	BABAR [Phys.Rev.D 101 (2020) 11, 112003]
$D^+ \rightarrow \pi^+ e^+ \mu^-$	2.9×10^{-6}	BABAR [Phys.Rev.D 84 (2011) 072006]
$D^+ \rightarrow \pi^+ e^- \mu^+$	3.6×10^{-6}	BABAR [Phys.Rev.D 84 (2011) 072006]
$D^+ \rightarrow \pi^- e^+ \mu^+$	2.0×10^{-6}	BABAR [Phys.Rev.D 84 (2011) 072006]
$D^+ \rightarrow K^+ e^+ \mu^-$	1.2×10^{-6}	BABAR [Phys.Rev.D 84 (2011) 072006]
$D^+ \rightarrow K^+ e^- \mu^+$	2.8×10^{-6}	BABAR [Phys.Rev.D 84 (2011) 072006]
$D^+ \rightarrow K^- e^+ \mu^+$	1.9×10^{-6}	BABAR [Phys.Rev.D 84 (2011) 072006]
$B^0 \rightarrow e^\pm \tau^\mp$	1.6×10^{-5}	Belle [Phys.Rev.D 104 (2021) 9, L091105]
$B^0 \rightarrow \mu^\pm \tau^\mp$	1.5×10^{-5}	Belle [Phys.Rev.D 104 (2021) 9, L091105]
$B^0 \rightarrow \pi^0 e^\pm \mu^\mp$	1.4×10^{-7}	BABAR [Phys.Rev.Lett. 99 (2007) 051801]
$B^0 \rightarrow K^0 e^\pm \mu^\mp$	2.7×10^{-7}	BABAR [Phys.Rev.D 73 (2006) 092001]
$B_s^0 \rightarrow e^\pm \tau^\mp$	14×10^{-4}	Belle [JHEP 08 (2023) 178]
$B_s^0 \rightarrow \mu^\pm \tau^\mp$	7.3×10^{-4}	Belle [JHEP 08 (2023) 178]
$\Upsilon(1S) \rightarrow e^\pm \mu^\pm$	3.9×10^{-7}	Belle [JHEP 05 (2022) 095]
$\Upsilon(1S) \rightarrow e^\pm \tau^\pm$	2.7×10^{-6}	Belle [JHEP 05 (2022) 095]
$\Upsilon(1S) \rightarrow \mu^\pm \tau^\pm$	2.7×10^{-6}	Belle [JHEP 05 (2022) 095]
$\Upsilon(2S) \rightarrow e^\pm \tau^\pm$	1.1×10^{-6}	Belle [JHEP 02 2024, 187 (2024)]
$\Upsilon(2S) \rightarrow \mu^\pm \tau^\pm$	2.3×10^{-7}	Belle [JHEP 02 2024, 187 (2024)]
$\Upsilon(3S) \rightarrow e^\pm \mu^\pm$	3.6×10^{-7}	BABAR [Phys.Rev.Lett. 128 (2022) 9, 091804]
$\Upsilon(3S) \rightarrow e^\pm \tau^\pm$	4.2×10^{-6}	BABAR [Phys.Rev.Lett. 104 (2010) 151802]
$\Upsilon(3S) \rightarrow \mu^\pm \tau^\pm$	3.1×10^{-6}	BABAR [Phys.Rev.Lett. 104 (2010) 151802]



Global analysis of all LFV data

SMEFT for CLFV

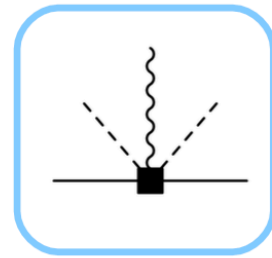

vector/axial currents

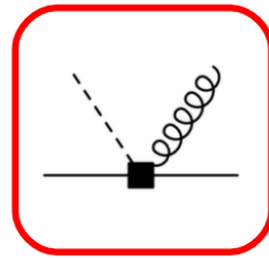

dipole

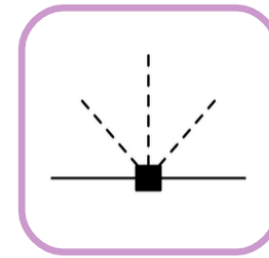

Yukawa

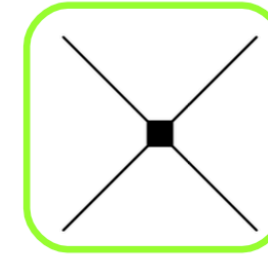

four-fermion

τ and B CLFV decays

Decay mode	V				A				S				P				T		
	$q^{(0)}$	$q^{(1)}$	s	c	b	$q^{(0)}$	$q^{(1)}$	s	c	b	$q^{(0)}$	$q^{(1)}$	s	c	b	u	c		
$\tau \rightarrow e\gamma$																		✓✓	
$\tau \rightarrow el^+l^-$					✓✓					××									
$\tau \rightarrow e\pi^0$						✓				××									
$\tau \rightarrow e\eta, \eta'$						✓				××									
$\tau \rightarrow e\pi^+\pi^-$					✓✓					××								✓	
$\tau \rightarrow eK^+K^-$					✓✓					××								✓	
	ds	db	sb	cu		ds	db	sb	cu		ds	db	sb	cu		ds	db	sb	cu
$\tau \rightarrow eK_S^0$						✓													
$\tau^- \rightarrow e^-K\pi$	✓																		
$B^0 \rightarrow e\tau$						✓													
$B^+ \rightarrow \pi^+e\tau$					✓														
$B^+ \rightarrow K^+e\tau$					✓														

✓ = tree ✓ = loop

V.Cirigliano, K.Fuyuto, C.Lee, E.Mereghetti, B.Yan,
[JHEP03, 256 \(2021\) arXiv:2102.06176 \[hep-ph\]](https://arxiv.org/abs/2102.06176)

Global fit: $\tau \rightarrow e$ decays and transitions with τ in the final state

Model-independent probes of new physics at scale (Λ) encoded as Wilson coefficients (C_n) via EFT approach. For certain operators, Higgs decay and LFV Drell-Yan compete, which are assumed to scale by factor of 4 at HL-LHC.

For all other operators, sensitivity dominated by τ and B-decays @ Belle II

Upper limit on LFV coupling and lower limit on new physics scale

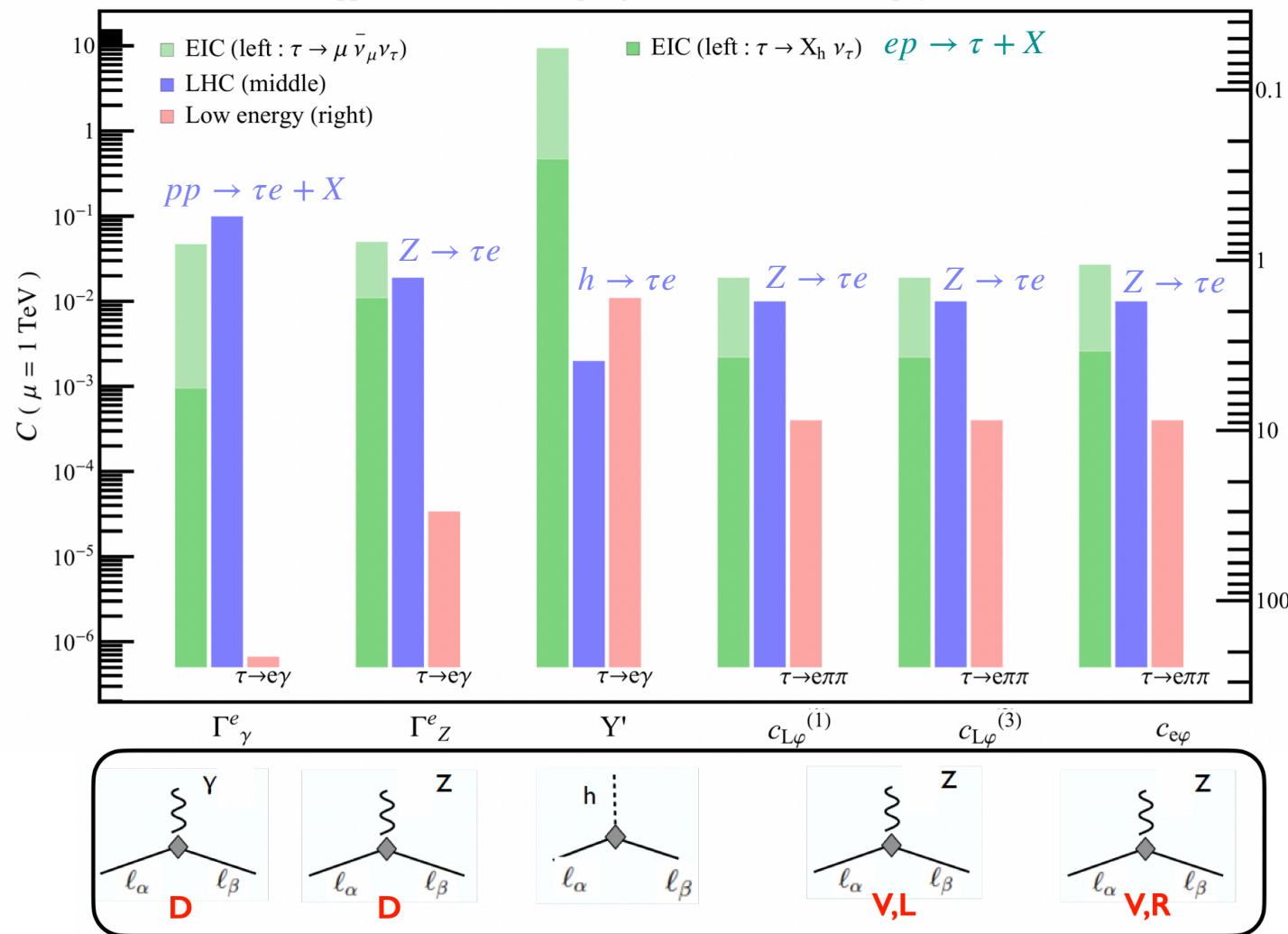

V.Cirigliano et. al. arXiv: 2102.06176 [hep-ph]

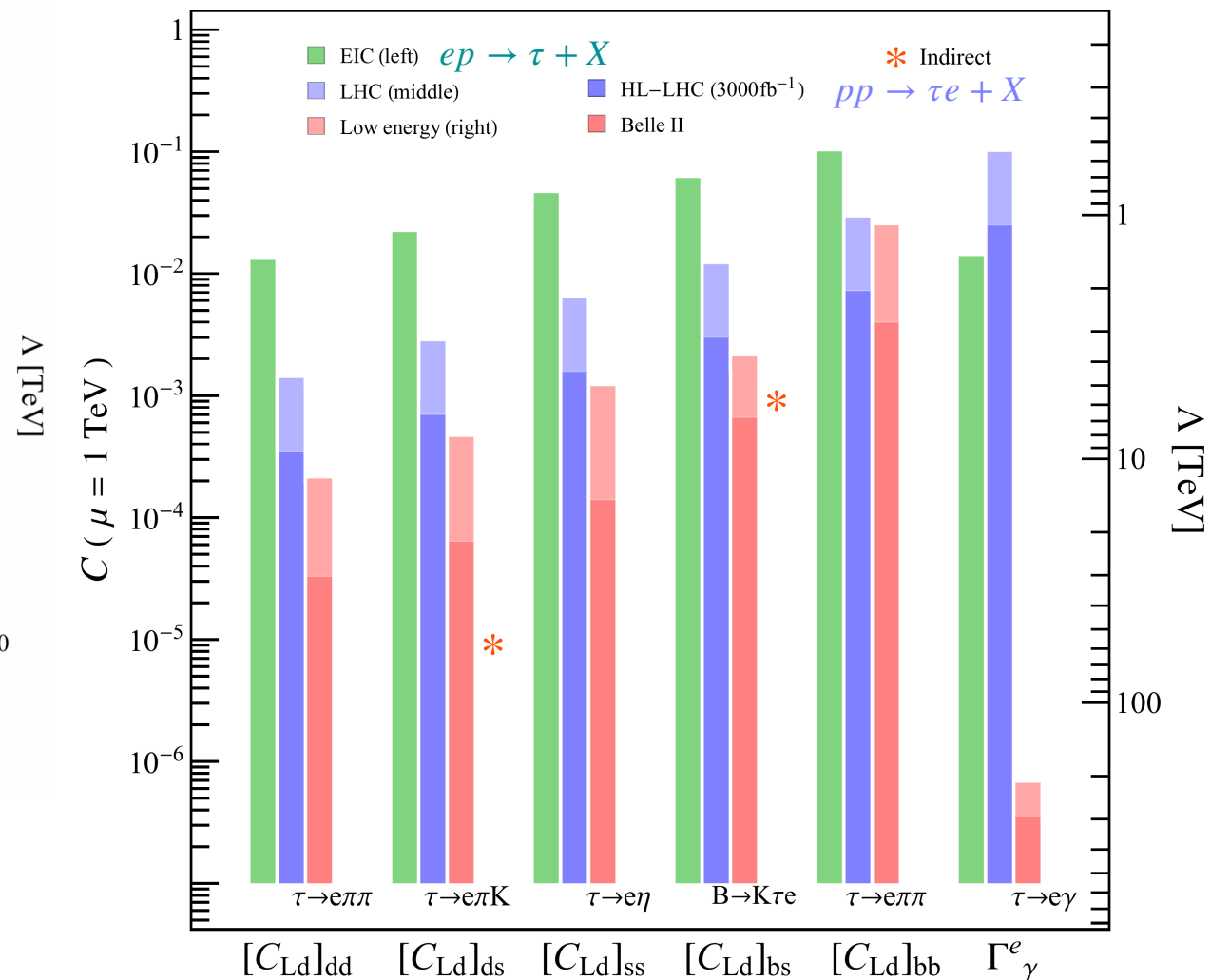

Sw. Banerjee, et.al. arXiv: 2203.14919 [hep-ph]

Global fit: $\tau \rightarrow \mu$ decays and transitions with τ in the final state

Model-independent probes of new physics at scale (Λ) encoded as Wilson coefficients (C_n) via EFT approach.
 For certain operators, Higgs decay and LFV Drell-Yan compete, which are assumed to scale by factor of 4 at HL-LHC.

For all other operators, sensitivity dominated by τ and B-decays @ Belle II

WC	Operator	WC	Operator
$C_{LQ}^{(1)}$	$(\bar{L}_p \gamma_\mu L_r) (\bar{Q}_s \gamma^\mu Q_t)$	$C_{e\varphi}$	$(\varphi^\dagger \varphi) (\bar{L}_p e_r \varphi)$
$C_{LQ}^{(3)}$	$(\bar{L}_p \gamma_\mu \sigma^I L_r) (\bar{Q}_s \gamma^\mu \sigma^I Q_t)$	$C_{\varphi e}$	$(\varphi^\dagger i \overleftrightarrow{D}_\mu \varphi) (e_p \gamma^\mu e_r)$
C_{eu}	$(\bar{e}_p \gamma_\mu e_r) (\bar{u}_s \gamma^\mu u_t)$	$C_{\varphi L}^{(1)}$	$(\varphi^\dagger i \overleftrightarrow{D}_\mu \varphi) (\bar{L}_p \gamma^\mu L_r)$
C_{ed}	$(\bar{e}_p \gamma_\mu e_r) (\bar{d}_s \gamma^\mu d_t)$	$C_{\varphi L}^{(3)}$	$(\varphi^\dagger i \overleftrightarrow{D}_{I\mu} \varphi) (\bar{L}_p \sigma_I \gamma^\mu L_r)$
C_{Lu}	$(\bar{L}_p \gamma_\mu L_r) (\bar{u}_s \gamma^\mu u_t)$	C_{eW}	$(\bar{L}_p \sigma^{\mu\nu} e_r) \sigma_I \varphi W_{\mu\nu}^I$
C_{Ld}	$(\bar{L}_p \gamma_\mu L_r) (\bar{d}_s \gamma^\mu d_t)$	C_{eB}	$(\bar{L}_p \sigma^{\mu\nu} e_r) \varphi B_{\mu\nu}$
C_{Qe}	$(\bar{Q}_p \gamma_\mu Q_r) (\bar{e}_s \gamma^\mu e_t)$		
C_{LedQ}	$(\bar{L}_p^j e_r) (\bar{d}_s Q_t^j)$		
$C_{LeQu}^{(1)}$	$(\bar{L}_p^j e_r) \varepsilon_{jk} (\bar{Q}_s^k u_t)$		
$C_{LeQu}^{(3)}$	$(\bar{L}_p^j \sigma_{\mu\nu} e_r) \varepsilon_{jk} (\bar{Q}_s^k \sigma^{\mu\nu} u_t)$		

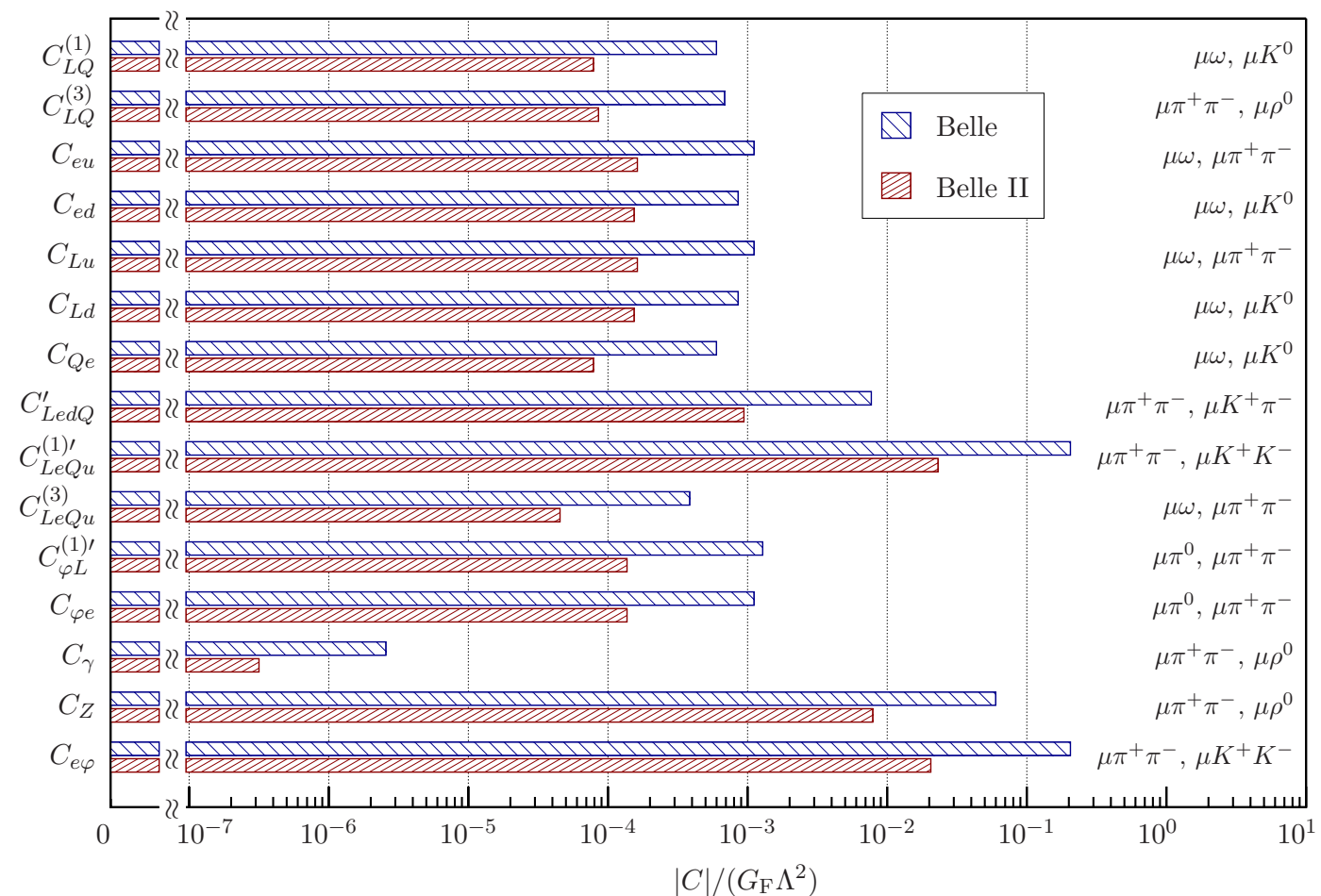

Husek, Monsalvez-Pozo, Portoles

[JHEP 04 \(2022\) 165 arXiv: 2111.06872 \[hep-ph\]](#)

[Sw. Banerjee, et.al. arXiv: 2203.14919 \[hep-ph\]](#)

Summary & Outlook

	Observed Limits			Projected Limits		
	Experiment	Luminosity	UL (obs)	Experiment	Luminosity	UL (exp)
$\tau^- \rightarrow e^- \gamma$	Belle [JHEP 10 (2021) 19]	988 fb ⁻¹	5.6×10 ⁻⁸	Belle II [2207.06307]	50 ab ⁻¹	9.0×10 ⁻⁹
	BaBar [Phys.Rev.Lett. 104 (2010) 021802]	516 fb ⁻¹	3.3×10 ⁻⁸			
$\tau^- \rightarrow \mu^- \gamma$	Belle [JHEP 10 (2021) 19]	988 fb ⁻¹	4.2×10 ⁻⁸	Belle II [2207.06307]	50 ab ⁻¹	6.9×10 ⁻⁹
	BaBar [Phys.Rev.Lett. 104 (2010) 021802]	516 fb ⁻¹	4.4×10 ⁻⁸	STCF [Eur.Phys.J.C 83 (2023) 10, 908]	10 ab ⁻¹	8.8×10 ⁻⁹
				FCC-ee [1811.09408]	150 ab ⁻¹	$\mathcal{O}(10^{-9})$
$\tau^- \rightarrow \mu^- \mu^+ \mu^-$	Belle II [Tau2023]	424 fb ⁻¹	1.9×10 ⁻⁸	Belle II [2207.06307]	50 ab ⁻¹	3.6×10 ⁻¹⁰
	Belle [Phys.Lett.B 687 (2010) 139]	782 fb ⁻¹	2.1×10 ⁻⁸			
	BaBar [Phys.Rev.D 81 (2010) 111101]	468 fb ⁻¹	3.3×10 ⁻⁸			
	LHCb [JHEP 02 (2015) 121]	3 fb ⁻¹	4.6×10 ⁻⁸	LHCb [1808.08865]	300 fb ⁻¹	$\mathcal{O}(10^{-9})$
	CMS [Phys. Lett. B 853 (2024) 138633]	131 fb ⁻¹	2.9×10 ⁻⁸	CMS [CMS-TDR-016]	3 ab ⁻¹	3.7×10 ⁻⁹
	ATLAS [Eur.Phys.J.C 76 (2016) 5, 232]	20 fb ⁻¹	3.8×10 ⁻⁷	ATLAS [ATL-PHYS-PUB-2018-032]	3 ab ⁻¹	1.0×10 ⁻⁹
				STCF [Eur.Phys.J.C 83 (2023) 10, 908]	1 ab ⁻¹	1.4×10 ⁻⁹
			FCC-ee [1811.09408]	150 ab ⁻¹	$\mathcal{O}(10^{-10})$	

- **Observation of LFV in the charged lepton sector would completely change our understanding of physics and herald a new period of discoveries in particle physics. Synergies between different experiments compliment discovery potential/confirmation.**
- **Now is a very interesting era in the searches for LFV in decays of the τ lepton, as the current limits will improve by an order of magnitude down to a few parts in 10^{-10} to 10^{-9} at the Belle II and other experiments.**
- **Similar sensitivities will be probed at ATLAS, CMS & LHCb with high luminosity upgrade.**
- **Proposed experiments at STCF, EIC & FCC-ee will continue searches for LFV in tau sector.**