

Bottomonium physics at Belle II

A. Boschetti
(on behalf of the
Belle II Collaboration)

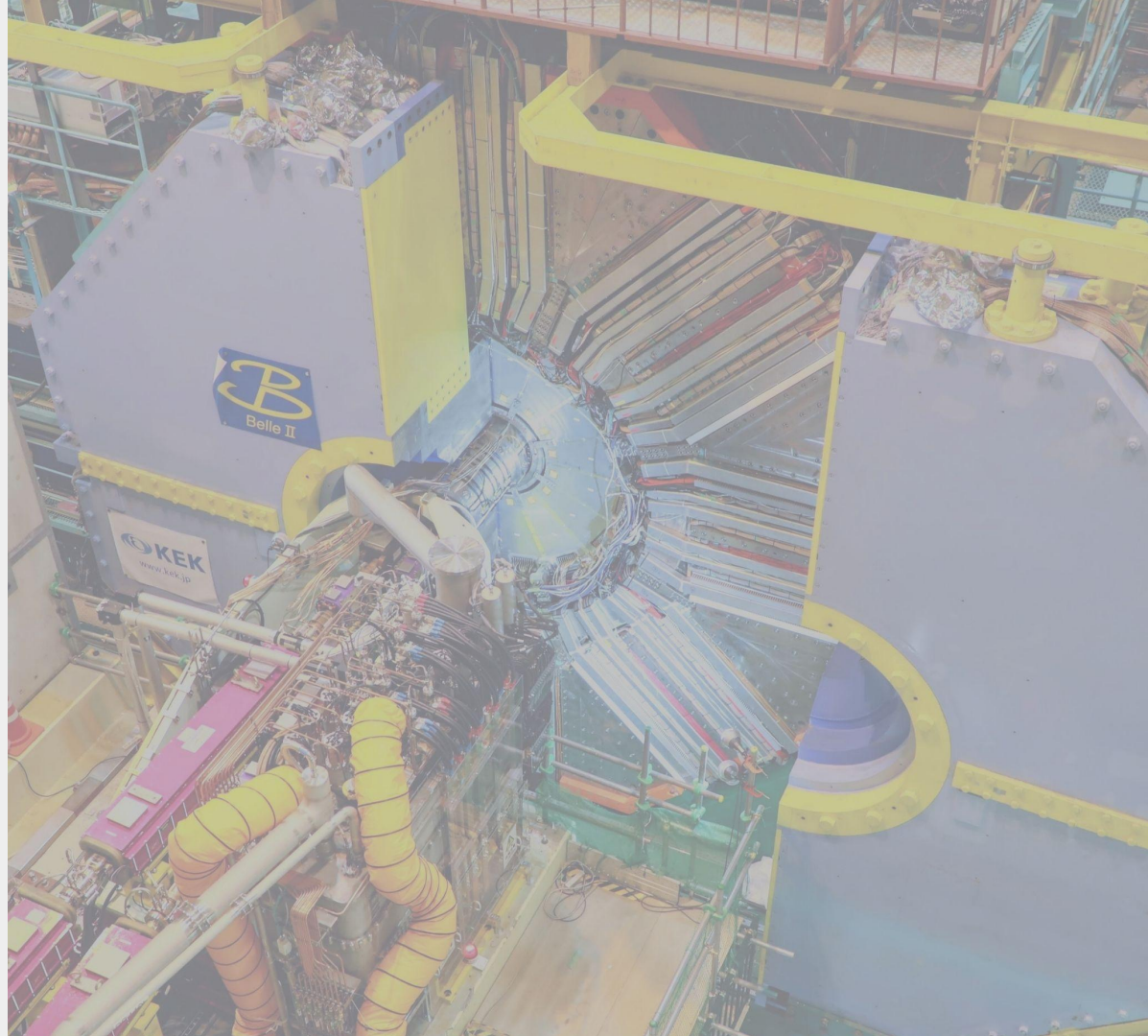

UNIVERSITÀ
DI TORINO



Heavy quarkonia

$m_Q \gg$ binding energy \Rightarrow **non-relativistic dynamics** inside bound state

Bottomonium: $v_b \sim 0.1c \Rightarrow m_b v_b < 1 \text{ GeV}$

\Rightarrow **non-perturbative QCD** regime

- Spectrum: NR quantum mechanics (+ relativistic corrections)
- Hadronic/EM transitions: multipole expansion of gluon/EM field

Works well in most cases!

But...

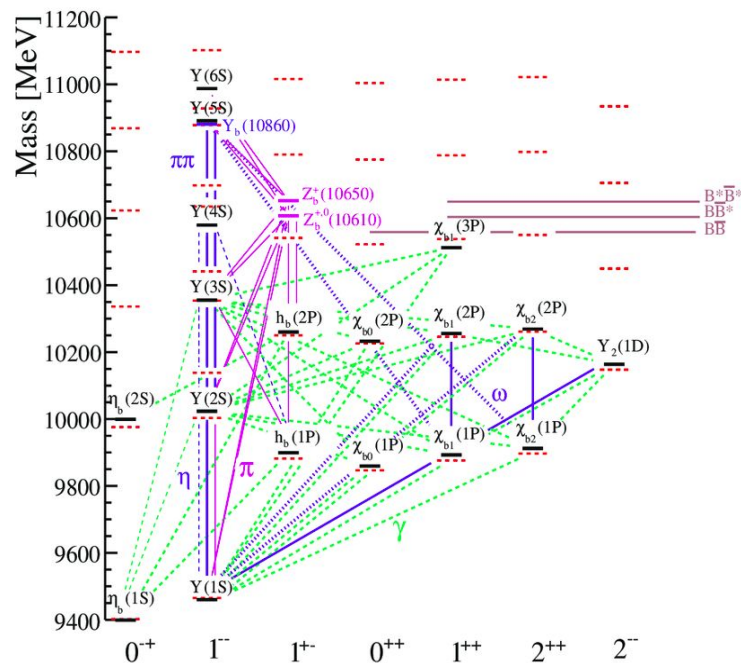

Bottomonium spectrum and transitions

Exotic hadrons

XYZ states:

- lots of them in charmonium
- bottomonium analogues: Y_b , Z_b , Z'_b

what are they?



which partons?

which color arrangement?

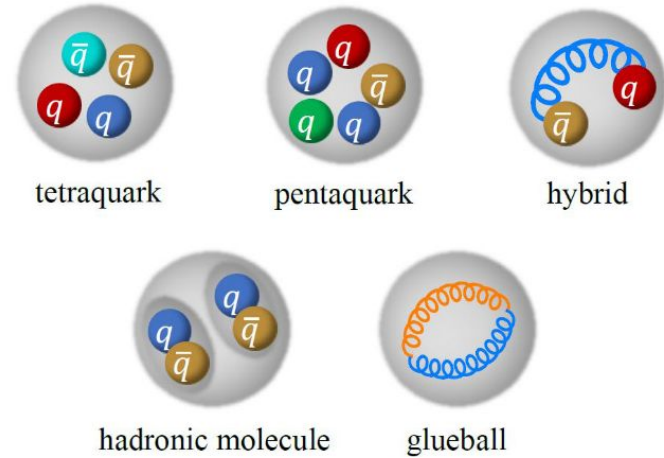

or kinematic effects:
thresholds, cusps

The Belle legacy

Belle@KEKB (**B-factory**) → optimized for

$$e^+e^- \rightarrow \Upsilon(4S) \rightarrow B\bar{B}$$

However, it left important legacy **above Y(4S)**:

- At Y(5S): discovery of $h_b(1,2P)$, $\eta_b(2S)$, $Z_b(10610,10650)$ [PR D91 072003, PRL 109 232002]
 - exotic states and anomalous $\pi\pi$ transition widths
- Energy scan data: **Y(10753)**
 - rise in hadronic transition cross sections (**resonance**)
 - dip in total $b\bar{b}$ cross section (**interference?**)

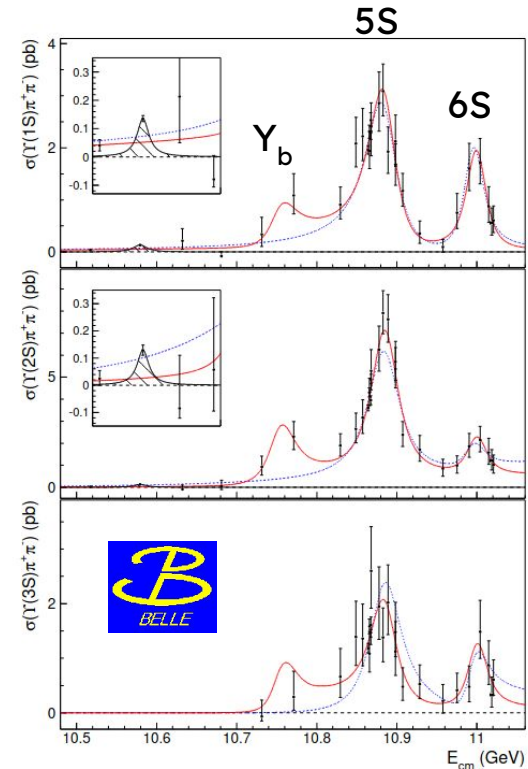

JHEP 10 (2019) 220

Y(10753): why it's important

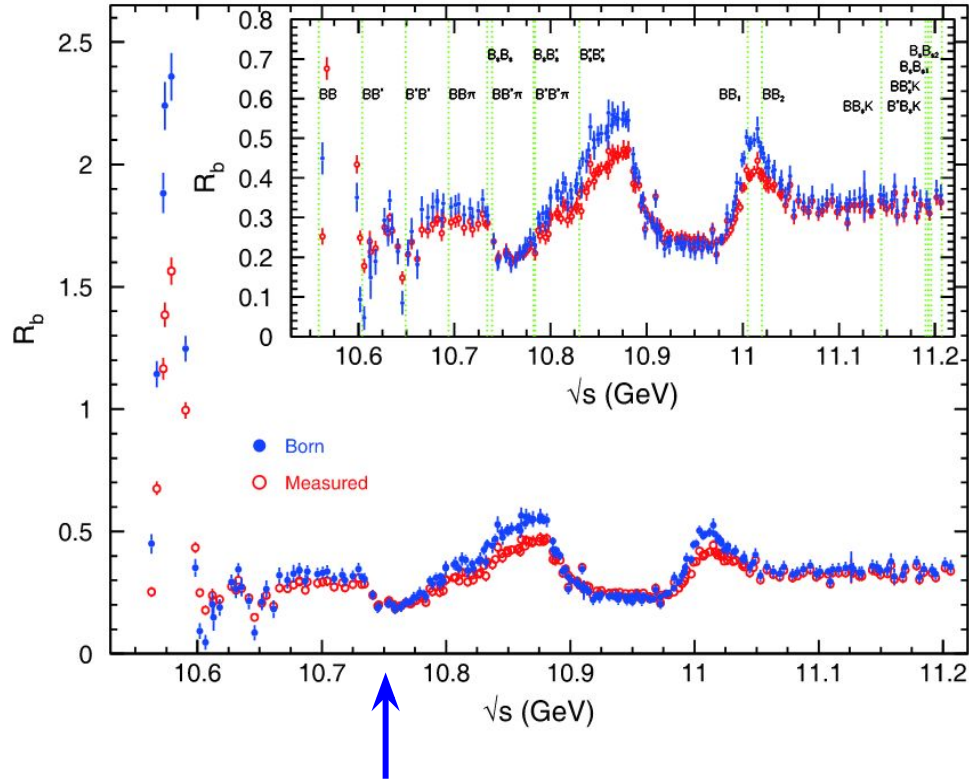

$$R_b = \frac{\sigma(e^+e^- \rightarrow b\bar{b})}{\sigma(e^+e^- \rightarrow \mu^+\mu^-)}$$

Dip: likely caused by interference between BW and smooth component

Chin. Phys. C 44 (2020) 8, 083001

Y(10753): why it's important

Uncertain nature:

- No clear conventional $b\bar{b}$ candidate
- Molecule? 10.75 GeV isn't a threshold...
- Tetraquark?

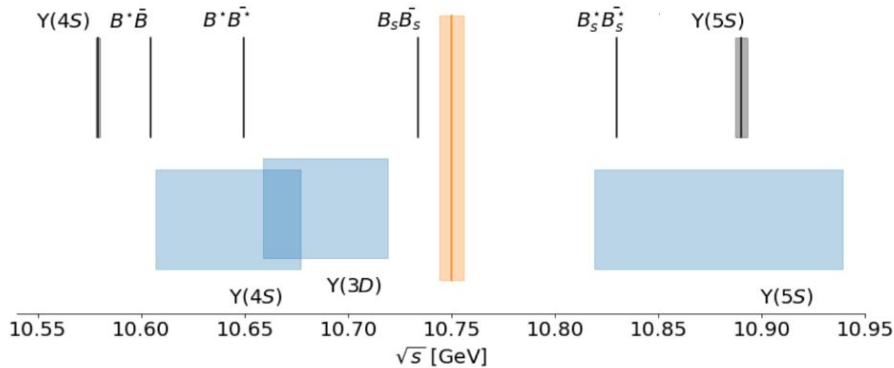

Conventional interpretations:

Chen, Zhang & He, PRD 101, 014020 (2020)
 Giron & Lebed, PRD 102, 014036 (2020)
 Li et al., EPJC 80, 59, (2020)
 Li et al., PRD 104, 034036 (2021)
 van Beveren & Oset, PPNP 117, 103845 (2021)
 Bai et al., PRD 105, 074007 (2022)
 Husken, Mitchell & Swanson, arXiv:2204.11915 (2022)
 Kher et al., EPJ+ 137, 357 (2022)
 Li, Bai & Liu, arXiv:2205.04049 (2022)
 Liang, Ikeno & Oset, PLB 803, 135340 (2020)

Exotic interpretations:

Wang, CPC 43, 123102 (2019)
 Ali, Maiani, Parkhomenko & Wang, PLB 802, 135217 (2020)
 Bicudo, Cardoso & Wagner, PRD 103, 074507 (2020)
 Castella & Passemar, PRD 104, 034019 (2021)

Belle II @ SuperKEKB



SuperKEKB:

- Asymmetric e+e- collider in Tsukuba, JPN
- Nano-beam interaction point
 - $\mathcal{L} = 4.7 \times 10^{34} \text{ cm}^{-2} \text{ s}^{-1}$ (record), $L = 424 \text{ fb}^{-1}$
- Tunable E_{cm} around $Y(4S)$ mass

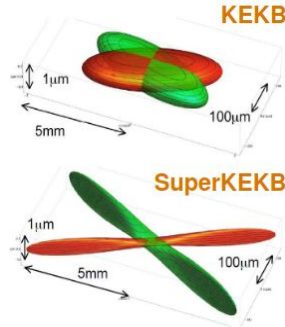
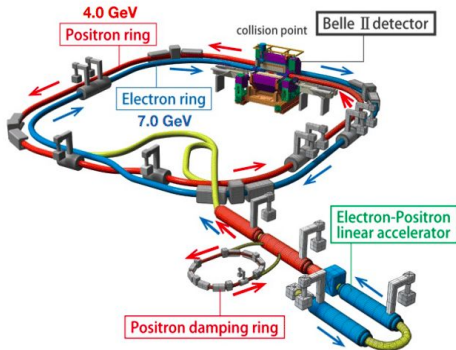
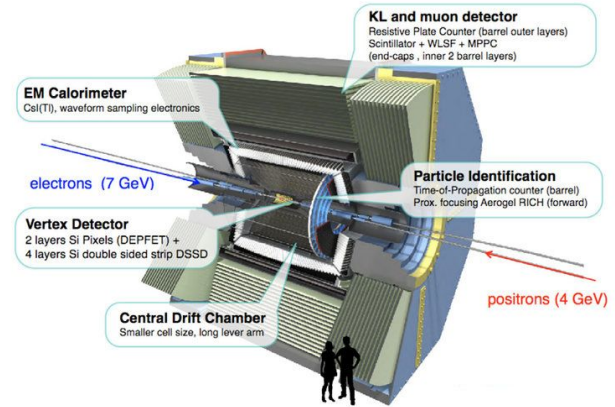

Belle II detector:

- $\sim 4\pi$ magnetic spectrometer with optimal vertexing, tracking, PID, calorimetry capabilities

See Giulia's talk for details



Above $Y(4S)$: Nov. 2021 energy scan

Analyses at $Y(10753)$: limited luminosity requirement ($\sim O(15 \text{ fb}^{-1})$)

The scan was successful: **19 fb^{-1}** collected at four E_{cm} points (between Belle's)

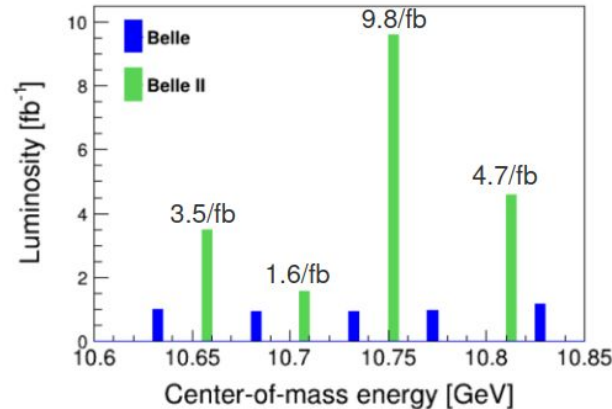

What are we doing with these data?

Belle II energy scan: new result



Observation of $e^+e^- \rightarrow \omega\chi_{bJ}(1P)$ and search for $X_b \rightarrow \omega\Upsilon(1S)$ at \sqrt{s} near 10.75 GeV

I. Adachi, L. Aggarwal, H. Ahmed, H. Aihara, N. Akopov, A. Aloisio, N. Anh Ky, T. Aushev, V. Aushev, H. Bae, P. Bambade, Sw. Banerjee, J. Baudot, M. Bauer, A. Beaubien, J. Becker, P. K. Behera, J. V. Bennett, E. Bernieri, F. U. Bernlochner, V. Bertacchi, M. Bertemes, E. Bertholet, M. Bessner, S. Bettarini, B. Bhuyan, F. Bianchi, T. Bilka, D. Biswas, D. Bodrov, A. Bolz, A. Bondar, J. Borah, A. Bozek, M. Bračko, P. Branchini, T. E. Browder, A. Budano, S. Bussino, M. Campajola, L. Cao, G. Casarosa, M.-C. Chang, P. Cheema, V. Chekelian, Y. Q. Chen, K. Chilikin, K. Chirapatpimol, H.-E. Cho, K. Cho, S.-J. Cho, S.-K. Choi, S. Choudhury, D. Cinabro, L. Corona, S. Cunliffe, S. Das, F. Dattola, E. De La Cruz-Burelo, S. A. De La Motte, G. De Nardo, M. De Nuccio, G. De Pietro, R. de Sangro, M. Destefanis, S. Dey, A. De Yta-Hernandez, R. Dhamija, A. Di Canto, F. Di Capua, Z. Doležal, I. Domínguez Jiménez, T. V. Dong, M. Dorigo, K. Dort, S. Dreyer, S. Dubey, G. Dujany, M. Eliachevitch, D. Epifanov, P. Feichtinger, T. Ferber, D. Ferlewicz, T. Fillinger, G. Finocchiaro, A. Fodor, F. Forti, B. G. Fulsom, ...

(The Belle II Collaboration)

We study the processes $e^+e^- \rightarrow \omega\chi_{bJ}(1P)$ ($J = 0, 1, \text{ or } 2$) using samples at center-of-mass energies $\sqrt{s} = 10.701, 10.745, \text{ and } 10.805$ GeV, corresponding to 1.6, 9.8, and 4.7 fb⁻¹ of integrated luminosity, respectively. These data were collected with the Belle II detector during a special run of the SuperKEKB collider above the $\Upsilon(4S)$ resonance. We report the first observation of $\omega\chi_{bJ}(1P)$ signals at $\sqrt{s} = 10.745$ GeV. By combining Belle II data with Belle results at $\sqrt{s} = 10.867$ GeV, we find energy dependencies of the Born cross sections for $e^+e^- \rightarrow \omega\chi_{b1,b2}(1P)$ to be consistent with the shape of the $\Upsilon(10753)$ state. Including data at $\sqrt{s} = 10.653$ GeV, we also search for the bottomonium equivalent of the $X(3872)$ state decaying into $\omega\Upsilon(1S)$. No significant signal is observed for masses between 10.45 and 10.65 GeV/ c^2 .

[arXiv:2208.13189](https://arxiv.org/abs/2208.13189) [hep-ex]



Belle II energy scan: new result

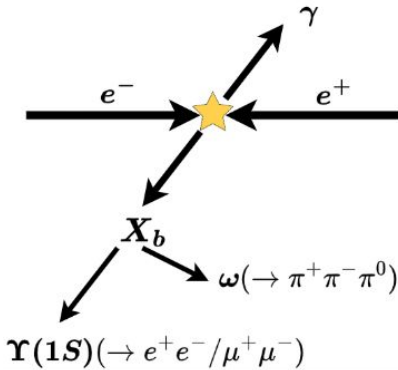
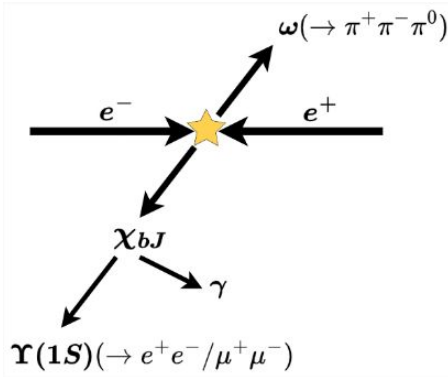

Motivations:

- Prediction for $\Upsilon(4S) - \Upsilon(3D)$ mixing:

$$\mathcal{B}[Y(10753) \rightarrow \omega \chi_{bJ}(1P)] \sim 10^{-3}$$

Li, Bai, Huang, Liu, Phys. Rev. D 104, 034036 (2021)

- BESIII observed

$$\begin{aligned} e^+e^- &\rightarrow Y(4220) \rightarrow \pi^+\pi^- J/\psi, \\ &\rightarrow \gamma X(3872), \\ &\rightarrow \omega \chi_{c0}(1P) \end{aligned}$$

⇒ X_b analog of $X(3872)$?

Belle II energy scan: new result

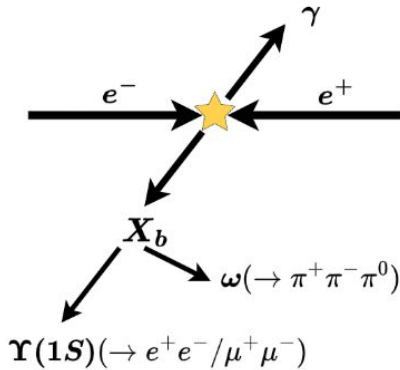
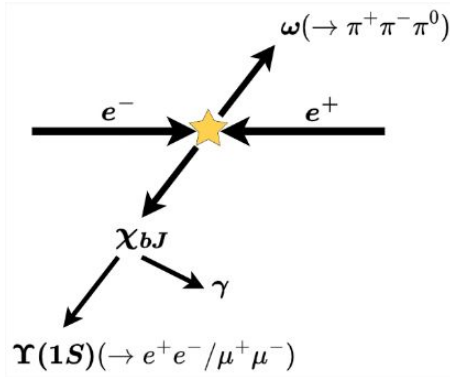

Selection criteria:

- 4 - 5 tracks
- standard Belle II PID (90 - 95% eff.)
- $E(\gamma) > 50$ MeV
- $105 < M(\gamma\gamma) < 150$ MeV/ c^2 (90% eff.)
- bremsstrahlung and FSR suppression
- 4C kinematic fit
- best candidate selection based on fit χ^2

$Y(10753) \rightarrow \omega \chi_{bJ}(1P)$: fit to signal yields

2D UML fit to $M(\gamma Y(1S))$ vs $M(\pi^+ \pi^- \pi^0)$

Model:

signal (CB for χ_{bJ} , Voigt for ω) +
peaking bkg (same) +
comb. bkg

	Channel	\sqrt{s} (GeV)	N^{sig}	σ_B (pb)
	$e^+e^- \rightarrow \omega \chi_{b0}$		$0.0^{+1.1}_{-0.0}$	< 16.6
	$e^+e^- \rightarrow \omega \chi_{b1}$	10.701	$0.0^{+2.1}_{-0.0}$	< 1.2
	$e^+e^- \rightarrow \omega \chi_{b2}$		$0.1^{+2.2}_{-0.1}$	< 2.5
	$e^+e^- \rightarrow \omega \chi_{b0}$		$3.0^{+5.5}_{-4.7}$	< 11.3
11 σ	$e^+e^- \rightarrow \omega \chi_{b1}$	10.745	$68.9^{+13.7}_{-13.5}$	$3.6^{+0.7}_{-0.7} \pm 0.5$
	$e^+e^- \rightarrow \omega \chi_{b2}$		$27.6^{+11.6}_{-10.0}$	$2.8^{+1.2}_{-1.0} \pm 0.4$
	$e^+e^- \rightarrow \omega \chi_{b0}$		$3.6^{+3.8}_{-3.1}$	< 11.4
4.5 σ	$e^+e^- \rightarrow \omega \chi_{b1}$	10.805	$15.0^{+6.8}_{-6.2}$	< 1.7
	$e^+e^- \rightarrow \omega \chi_{b2}$		$3.3^{+5.3}_{-3.8}$	< 1.6

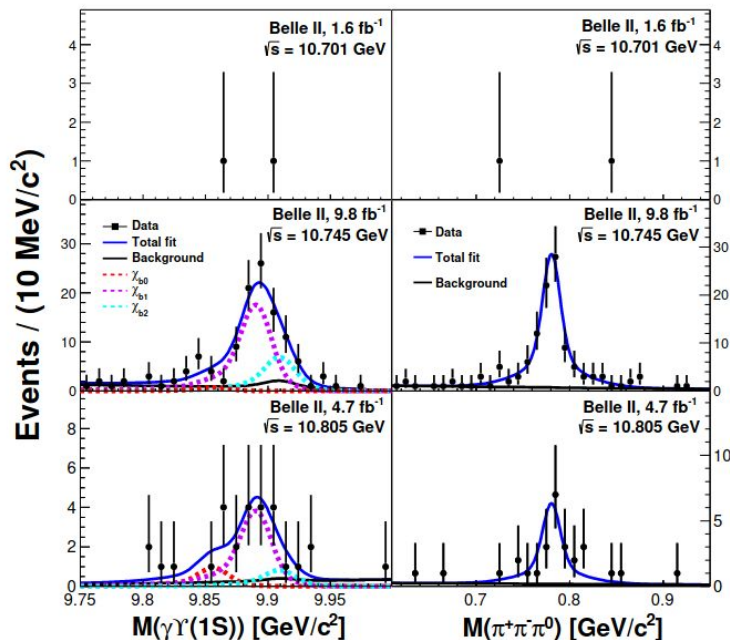

Peaks on $\chi_{b1,2}(1P)$

Peaks on ω

[arXiv:2208.13189](https://arxiv.org/abs/2208.13189)
[hep-ex]

$Y(10753) \rightarrow \omega \chi_{bJ}(1P)$: fit to σ_B

Triangle in plot: Belle result

Now we can see that the peak is at 10.75 GeV !

No clear peak at 10.860 GeV

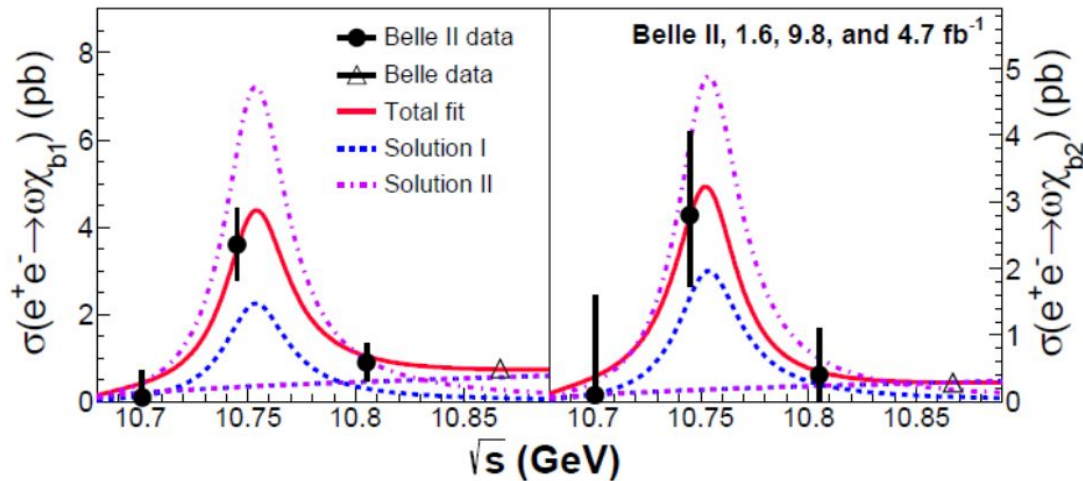

Search for $X_b \rightarrow \omega Y(1S)$

- Search for resonances in $M(\omega Y(1S))$
- Reflection from $Y(10753) \rightarrow \omega \chi_{bJ}(1P)$
- No evidence for X_b signal

⇒ Upper limit to σ_{X_b}

\sqrt{s} (GeV)	M_{X_b} (GeV)	$\sigma_{X_b}^{UL}$ (pb)
10.653	10.59	0.55
10.701	10.45	0.84
10.745	10.45	0.14
10.805	10.53	0.47

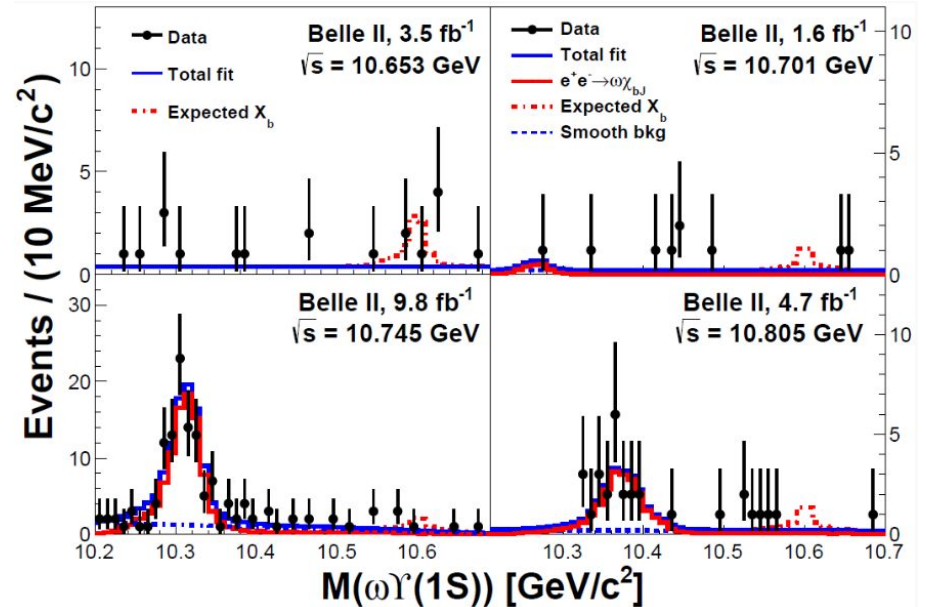

Y(10753) scan @Belle II: the future

Golden Modes
$e^+e^- \rightarrow \pi^+\pi^-\Upsilon(pS)(\rightarrow \ell^+\ell^-)$
$B\bar{B}$ decomposition
$\pi^+\pi^-$ Dalitz
$Y_b \rightarrow \omega\eta_b(1S)$
$Y_b \rightarrow \omega\chi_{bJ}(1P)$
Silver Modes
$Y_b \rightarrow \pi^+\pi^- X$ (inclusive)
$Y_b \rightarrow \eta X$ (inclusive)
$Y_b \rightarrow \eta\Upsilon(1S, 2S)(\rightarrow \ell^+\ell^-)$
$Y_b \rightarrow \eta'\Upsilon(1S)(\rightarrow \ell^+\ell^-)$
$Y_b \rightarrow \Upsilon(1S)$ (inclusive)
Bronze Modes
$Y_b \rightarrow \gamma X_b$
$Y_b \rightarrow \pi^0\pi^0\Upsilon(pS)(\rightarrow \ell^+\ell^-)$
$Y_b \rightarrow KK(\phi)\Upsilon(pS)(\rightarrow \ell^+\ell^-)$
$Y_b \rightarrow \pi^0\pi^0 X$ (inclusive)
$Y_b \rightarrow \pi^0 X$ (incl. or excl.)
...

- Reconstruction of hadronic/EM transitions
- Branching ratio measurement
- Cross sections vs. E_{cm} measurement
- Precise decomposition of the R_b ratio
- Systematic exploration of threshold regions
- Search for new exotic states

Hyperons and dibaryons

Moreover we can observe
(Belle + Belle II data):

$$e^+e^- \rightarrow Y(1,2S) \rightarrow ggg, \quad e^+e^- \rightarrow qq\bar{}$$

- Inclusive production of (anti)deuteron
- Low momentum hyperons
 - search for H-dibaryon
 - femtoscopic dynamic correlations

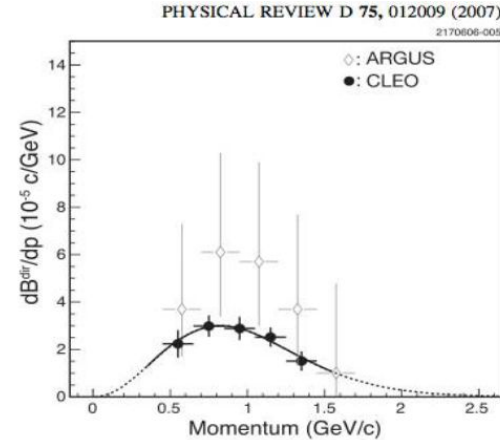

See Bianca's talk for details

Summary



We are at the beginning of a rich quarkonium physics program

Belle II collected **unique data** near $E_{\text{cm}} \sim 10.75$ GeV

- Unique quarkonium production at SuperKEKB
- Resonant transition $Y(10753) \rightarrow \omega \chi_{bJ}(1P)$ observed for the 1st time
- No evidence for X_b

Many ongoing analyses on 4S and scan data!

My PhD project: study of baryon-baryon interactions with femtoscopy



Thank you

BACKUP

$e^+e^- \rightarrow B\bar{B}$ decomposition

$$e^+e^- \rightarrow B\bar{B}, B\bar{B}^*, B^*\bar{B}^*$$

Target: Moriond 2023

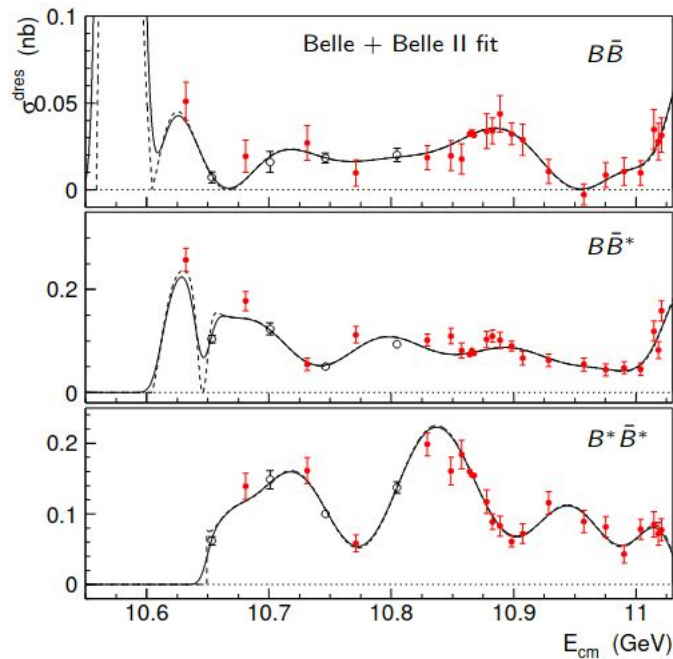
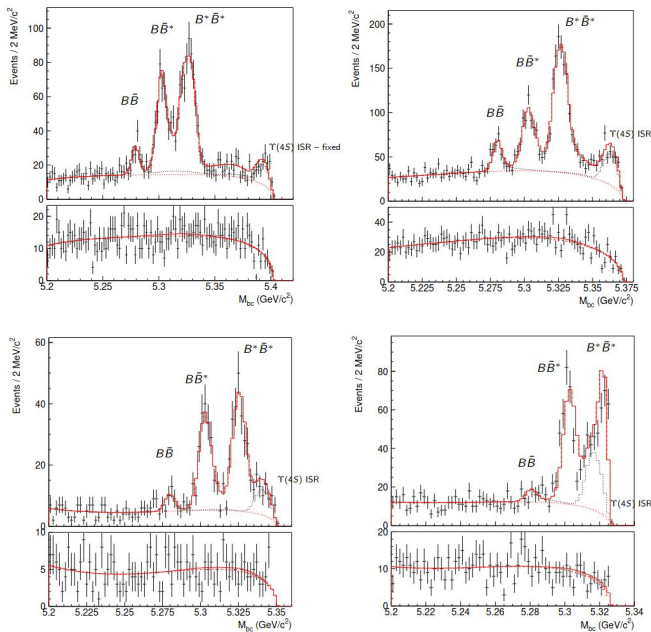

$e^+e^- \rightarrow \pi^+\pi^-Y(pS) [\rightarrow l^+l^-]$

Analyzed data: on and off-resonance 4S + above 4S scan

Main backgrounds: low mult., QED processes

Target: Moriond 2023

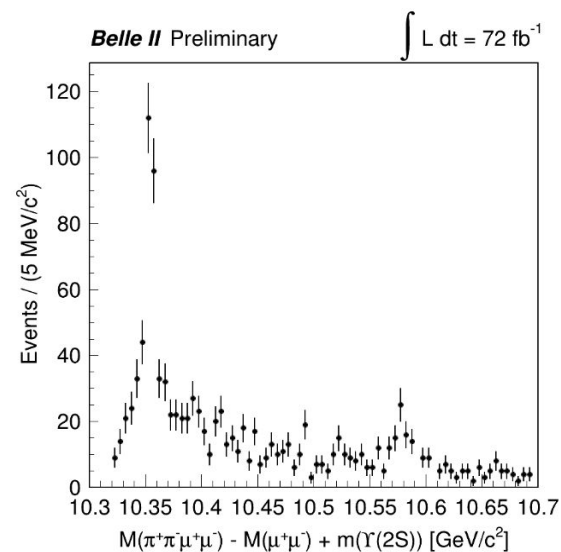
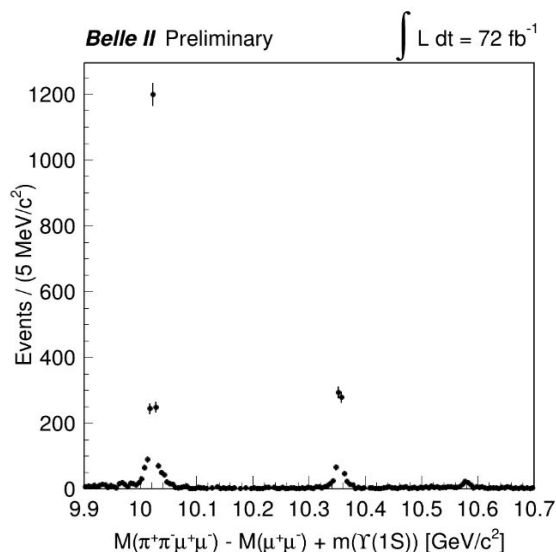
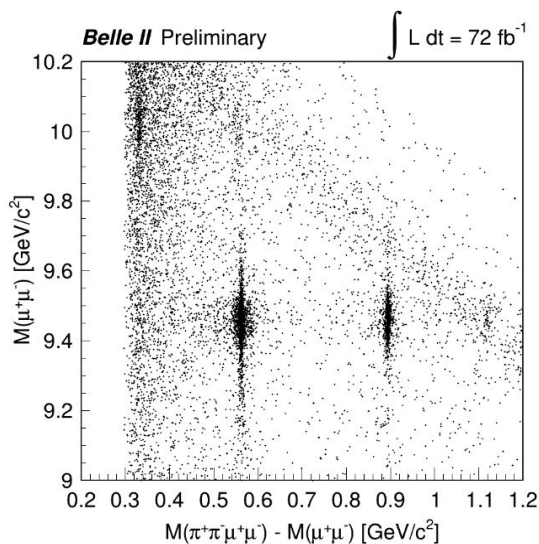

Femtoscscopy studies (Belle II + Belle)

Subject of my PhD thesis

Λ dynamics in neutron stars should affect the EoS, based on Λ - Λ (Λ -N) interaction (attractive / repulsive?)

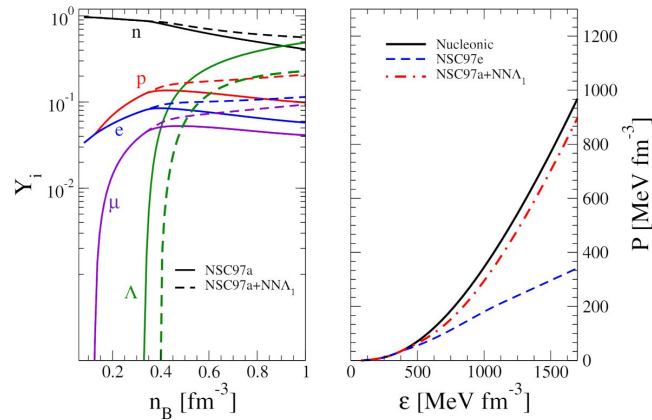

Universe 2021, 7, 408

- $e^+e^- \rightarrow qq^- \rightarrow \Lambda\Lambda X$
 - $e^+e^- \rightarrow Y(nS) \rightarrow ggg \rightarrow \Lambda\Lambda X$
- Dynamic correlations between Λ 's
 ⇒ constraints on interaction models
 ⇒ constraints on neutron star EoS

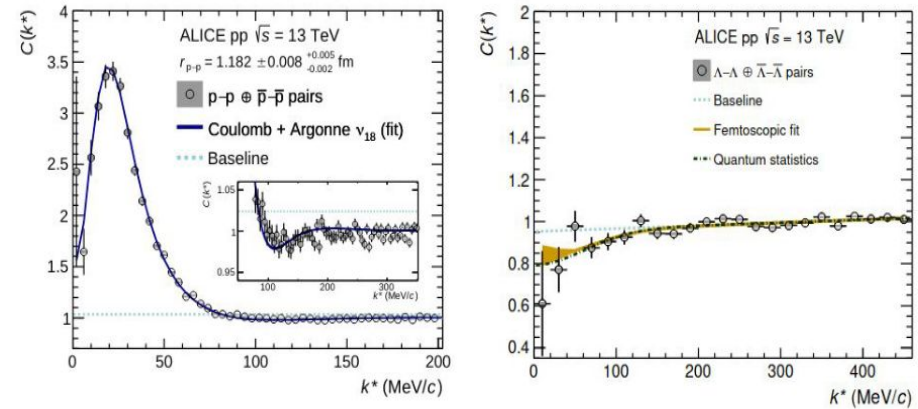

PLB 797, 134822 (2019)



Femtoscopia studies (Belle II + Belle)



Two-particle dynamic correlations bring information about

- interactions between them
- geometry of the emitting source

Λ - Λ interactions using femtoscopy:

- mixed event technique: method already used at ALICE
- we have a cleaner experimental environment

Applications: neutron star EoS, nuclear force, H-dibaryon, ...

$$C(k^*) \propto \frac{N_{same}(k^*)}{N_{mixed}(k^*)}$$

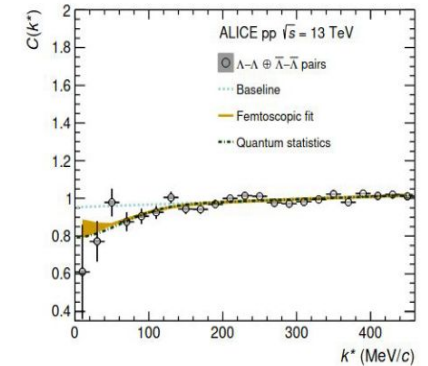
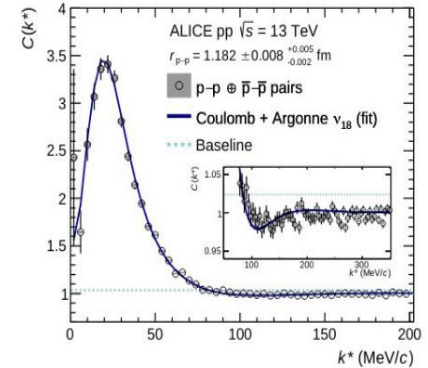

PID with the TOP detector

Key improvement in PID w.r.t. Belle

TOP = DIRC in the time domain

- Cherenkov light trapped and propagated to the readout in bar of fused silica
- Cherenkov angle measured by the time of propagation

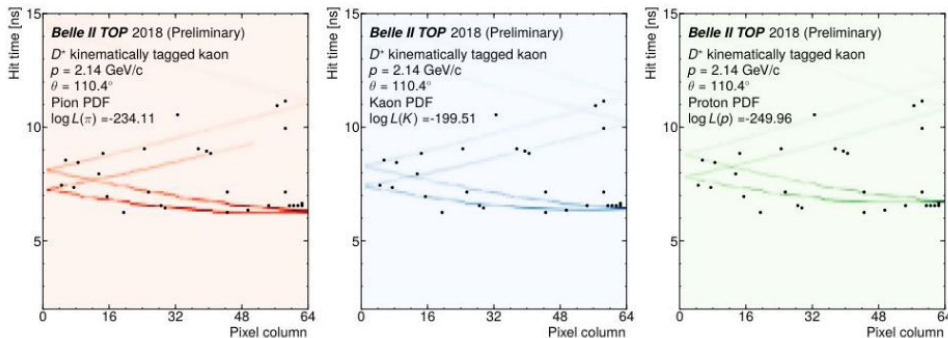
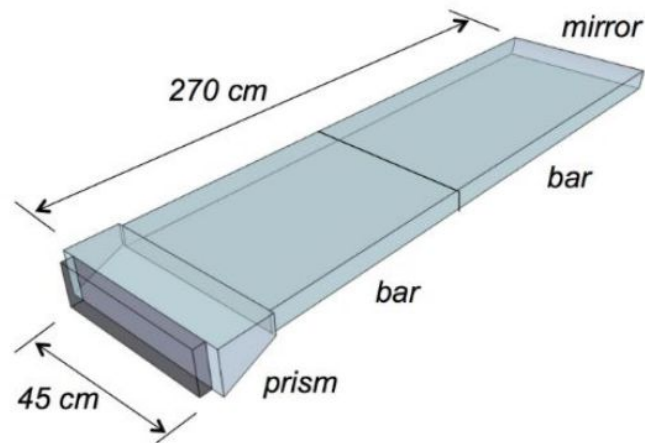

The running α_s

At low Q (< 1 GeV), $\alpha_s \sim 1$

⇒ Perturbation theory doesn't work

(Non-perturbative QCD)

- lots of effective theories
- unknown couplings and/or mechanisms

⇒ Large theor. uncertainties

How can we help?

